

The right choice for the ultimate yield!

LS ELECTRIC strives to maximize your profits in gratitude for choosing us as your partner.

AC Variable Speed Drive

SV-iS7 series

User's Manual

0.75-75kW [200V] 0.75-375kW [400V]



Safety Instructions

- Read this manual carefully before installing, wiring, operating, servicing or inspecting this equipment.
- Keep this manual within easy reach for quick reference.

 021-88406044
09106611367
WWW.LSKALA.COM
LSELECTRIC

-
- SV-iS7 is the official name for the iS7 series inverters.
 - This operation manual is intended for users with basic knowledge of electricity and electric devices.
 - Keep this manual near the product for future reference whenever setting change, maintenance or service is required.
 - Ensure that the field operators and service engineers can easily access this manual.
 - For detailed information about the optional extension boards, including the specifications and the requirements for installation and operation, refer to the instruction manuals that are supplied with the products.

Safety Information

Read and follow all safety instructions in this manual precisely to avoid unsafe operating conditions, property damage, personal injury, or death.

Safety symbols in this manual

Danger

Indicates an imminently hazardous situation which, if not avoided, will result in severe injury or death.

Warning

Indicates a potentially hazardous situation which, if not avoided, could result in injury or death.

Caution

Indicates a potentially hazardous situation which, if not avoided, could result in minor injury or property damage.

Safety information

Danger

- Do not open the cover of the equipment while it is on or operating. Likewise, do not operate the inverter while the cover is open. Exposure of the high voltage terminals or the charging area to the external environment may result in an electric shock. Do not remove any covers or touch the internal circuit boards (PCBs) or electrical contacts on the product when the power is on or during operation. Doing so may result in serious injury, death, or serious property damage.
- Do not open the cover of the equipment, even when the power supply to the inverter has been turned off, unless it is necessary for maintenance or regular inspection. Opening the cover may result in an electric shock even when the power supply is off.
- The equipment may hold a charge long after the power supply has been turned off. Use a multi-meter to make sure that the remaining voltage is below 30 VDC before working on the inverter, motor, or motor cable.

Warning

- This equipment must be grounded for safe and proper operation.
- Do not supply power to a faulty inverter. If you find that the inverter is faulty, disconnect the power supply and have the inverter professionally repaired.
- The inverter becomes hot during operation. Avoid touching the inverter until it has cooled to avoid burns.
- Do not allow foreign objects, such as screws, metal chips, debris, water, or oil, to get inside the inverter. Allowing foreign objects inside the inverter may cause the inverter to malfunction or result in a fire.
- Do not operate the inverter with wet hands. Doing so may result in electric shock.

Caution

- Do not modify the interior workings of the inverter. Doing so will void the warranty.
- Do not use cables with damages or cracks on the protective insulation when wiring the inverter. Damaged insulation may cause misoperation, an electric shock or a fire.
- Do not place heavy objects on top of electric cables. Doing so may damage the cable and result in an electric shock.

Note

[English]

The maximum allowed prospective short-circuit current at the input power connection is defined in IEC 60439-1 as 100 kA. The drive is suitable for use in a circuit capable of delivering not more than 100 kA RMS at the drive's maximum rated voltage, depending on the selected MCCB. RMS symmetrical amperes for recommended MCCB are the following table.

[French]

Le courant maximum de court-circuit présumé autorisé au connecteur d'alimentation électrique est défini dans la norme IEC 60439-1 comme égal à 100 kA. L'entraînement convient pour une utilisation dans un circuit capable de délivrer pas plus de 100 kA RMS à la tension nominale maximale de l'entraînement. Le tableau suivant indique le MCCB recommandé selon le courant RMS symétrique en ampères.

Working Voltage	UTE100 (E/N)	UTS150 (N/H/L)	UTS250 (N/H/L)	UTS400 (N/H/L)		
240V(50/60Hz)	50/65kA	65/100/150kA	65/100/150kA	65/100/150kA		
480V(50/60Hz)	25/35kA	35/65/100kA	35/65/100kA	35/65/100kA		
Working Voltage	ABS33c	ABS53c	ABS63c	ABS103c	ABS203c	ABS403c
240V(50/60Hz)	30kA	35kA	35kA	85kA	85kA	75kA
480V(50/60Hz)	7.5kA	10kA	10kA	26kA	26kA	35kA

About This Manual

This operation manual describes the specifications of the SV-iS7 series inverters and provides detailed information required for the installation, operation, and maintenance of the products.

This operation manual is intended for users with a basic knowledge of electricity and electric devices. Read this manual carefully to install, operate, and maintain the products safely and properly.

The following table lists the chapters in this manual, and brief descriptions of the information provided:

Chapter	Chapter name	Information provided
1	About the Product	Basic information about the product that is required for safe installation and operation
2	Technical Specifications	Product ratings and I/O types
3	Installing the Inverter	Information required for the installation of the product, including considerations for installation locations and operation environment
4	Connecting the Cables	Information required for connecting power supply and signal cables
5	Peripheral Devices	Information about the peripheral devices that can be connected to the input and output terminals of the product
6	Using the Keypad	Information about the keypad display and the operation keys on the keypad
7	Basic Functions	Information about configuring the inverter to run the basic functions
8	Learning Advanced Features	Information about configuring the inverter for advanced system application
9	Using Monitor Functions	Information about monitoring the inverter for operation statuses and trip conditions
10	Using Protection Features	Information about the functions to protect the motor and the inverter
11	Communication Function	Specifications for the RS-485 network communication between inverters and other devices
12	Troubleshooting and Maintenance	Information about identifying the failures and anomalies during operation and resolving them
13	Table of Functions	Table of all functions with brief descriptions
14	Functional Safety	Information about the products compliant with the safety standards, and the safety functions
15	Classified Product	Information about the products approved for marine application
16	Using a Single Phase Power Source	Considerations for operating the inverter with a single phase power source

Table of Contents

1	About the Product	1
1.1	Preparing for Installation and Operation.....	1
1.1.1	Identifying the Product	1
1.1.2	Checking the Product for Defects or Damage.....	3
1.1.3	Preparing the Product for Installation and Operation	3
1.1.4	Installing the Product	3
1.1.5	Connecting the Cables.....	3
1.2	Part Names	4
1.2.1	Interior and Exterior View (IP 21 Model Types Less than 22 kW [200 V] / Less than 75 kW [400 V]).....	4
1.2.2	Interior and Exterior View (IP 54 Model Types Less than 22 kW [200/400 V]).....	5
1.2.3	Interior and Exterior View (Model Types 30 kW and up [200 V] / 90 kW and up [400 V]).....	6
2	Technical Specifications	7
2.1	Input and Output Specifications 200 V Class (0.75–22 kW)	7
2.2	Input and Output Specifications 200 V Class (30–75 kW).....	8
2.3	Input and Output Specifications 400 V Class (0.75–22 kW)	9
2.4	Input and Output Specifications 400 V Class (30–160 kW)	10
2.5	Input and Output Specifications 400 V Class (185–375 kW)	11
2.6	Product Specification Details	13
2.6.1	Control	13
2.6.2	Operation	13
2.6.3	Protection Function.....	15
2.6.4	Structure and Operating Environment Control	15
3	Installing the Inverter	17
3.1	Installation Considerations	17
3.2	Selecting and Preparing a Site for Installation.....	18
3.3	Exterior and Dimensions (UL Enclosed Type 1, IP21 Type).....	22
3.4	Exterior and Dimensions (UL Enclosed Type 12, IP54 Type)	36
3.5	Frame Dimensions and Weight (UL Enclosed Type 1, IP 21 Type).....	40
3.6	Frame Dimensions and Weight (UL Enclosed Type 12, IP54 Type).....	42
3.7	Installation Procedures for UL Enclosed Type12 and IP54 Type Products	43

3.7.1	Disassembling the Keypad Cover and Keypad.....	43
3.7.2	Disassembling the IP54 Front Cover	44
3.7.3	Mounting the Inverter	45
3.7.4	Connecting the Power Cables.....	46
3.7.5	Reassembling the IP54 Front Cover and the Keypad	47
4	Connecting the Cables.....	49
4.1	Removing the Front Cover for Cable Connection.....	49
4.1.1	IP 21 Type Products.....	49
4.1.2	IP 54 Type Products.....	51
4.1.3	90–375 kW, 400 V and 30–75 kW, 200 V Products	52
4.2	Activating and Deactivating the Built-in EMC Filter	53
4.2.1	Up to 7.5 kW Inverters	53
4.2.2	11–22 kW Inverters.....	55
4.3	Precautions for Wiring the Inverter	57
4.4	Ground Connection	58
4.5	Terminal Wiring Diagram	59
4.5.1	Up to 7.5 kW Inverters.....	59
4.5.2	11–22 kW Inverters.....	59
4.5.3	30–75 kW Inverters.....	59
4.5.4	90–160 kW Inverters	59
4.5.5	185–220 kW Inverters.....	60
4.5.6	280–375 kW Inverters.....	60
4.6	Connecting Cables to the Power Terminal Block	61
4.6.1	0.75–22 kW (200 V/400 V).....	61
4.6.2	30–75 kW (200 V/400 V)	62
4.6.3	90–160 kW (400 V).....	63
4.6.4	185–220 kW (400 V)	64
4.6.5	280–375 kW (200 V/400 V).....	65
4.7	Specifications of the Power Terminal Block and Exterior Fuse.....	66
4.7.1	Cable Length between the Inverter and the Motor	67
4.7.2	Protective Measures for the Inverter and the Motor	68
4.8	Control Terminal Wiring for iS7 Inverters Rated for Up To 22 kW.....	69
4.8.1	NPN Mode (Sink).....	70
4.8.2	PNP Mode (Source)	70
4.8.3	0.75–22 kW (Basic I/O)	71
4.9	Control Terminal Wiring for iS7 Inverters Rated for 30 kW or More	72
4.10	Terminal Inputs for Inverter Operation.....	73
4.11	Cable Specifications for Control Block Wiring	75

4.12	Control Terminal Wiring for iS7 Extension I/O (Optional).....	76
4.13	Terminal Inputs for Inverter Operation.....	77
4.14	Cable Specifications for Control Block Wiring	78
4.15	Setting the Built-in Surge Filter.....	79
4.16	Activating or Deactivating the Surge Filter	80
4.16.1	iS7 30–75KW (400 V) Inverters	80
4.16.2	iS7 90–375 kW (400V) Inverters	80
4.17	Post-Installation Checklist.....	82
4.18	Test Run.....	83
4.18.1	Entering Easy Start Mode.....	83
4.18.2	Setting the Basic Parameters in Easy Start Mode	84
4.18.3	Checking the Inverter Operation	85
5	Peripheral Devices.....	86
5.1	Wiring Switch, Electronic Contactor, and Reactor Specifications	87
5.1.1	Wiring Switch, Short Circuit Switch, and Electronic Contactor	87
5.1.2	Reactors	89
5.1.3	Dynamic Braking Unit (DBU) and Resistor	92
5.1.4	DB Unit Dimensions.....	96
5.1.5	Indicators on the DB unit.....	102
5.1.6	DB Resistors.....	102
5.1.7	DB Resistor Dimensions.....	105
5.1.8	Keypad Extension Cable for Remote Control (Optional)	106
6	Using the Keypad.....	109
6.1	About the Keypad.....	109
6.1.1	Dimensions	109
6.1.2	Key Functions	110
6.1.3	Display Items	111
6.1.4	Display Item List.....	111
6.2	Menu Items.....	114
6.2.1	Parameter Mode.....	115
6.2.2	User & Macro Mode	116
6.3	Navigating Modes	117
6.3.1	Mode Navigation at the Factory Default.....	117
6.3.2	Mode Navigation with User/Macro Mode and Trip Mode.....	118
6.4	Navigating Modes and Parameters	120
6.4.1	Group Navigation in Parameter mode	120
6.4.2	Group Shift in User & Macro Mode.....	122
6.5	Navigating through Codes (Function Items)	123

6.5.1	Code Navigation in Monitor Mode	123
6.5.2	Code Navigation (function items) in Other Modes and Groups	124
6.5.3	Code Navigation Using Jump Code.....	125
6.6	Setting Parameters	127
6.6.1	Parameter Settings in Monitor Mode.....	127
6.6.2	Parameter Settings in Other Modes and Groups	128
6.7	Monitoring Operating Status.....	129
6.7.1	Using Monitor Mode.....	129
6.7.2	Monitoring Items.....	130
6.7.3	Using the Status Display.....	131
6.8	Monitoring Faults	132
6.8.1	Faults during Inverter Operation	132
6.8.2	Multiple Faults at a Time during Inverter Operation	133
6.8.3	Saving and Monitoring the Fault Trip History.....	133
6.9	Initializing Parameters	135
7	Basic Functions.....	137
7.1	Setting Frequency References	137
7.1.1	Keypad as the Source (KeyPad-1 setting)	138
7.1.2	Keypad as the Source (KeyPad-2 setting)	138
7.1.3	V1 Terminal as the Source	138
7.1.4	Setting a Frequency Reference Using an I/O Expansion Module (Terminal V2/I2)	148
7.1.5	Setting a Frequency with Pulse Input (with an optional encoder module).....	150
7.1.6	Setting a Frequency Reference via RS-485 Communication.....	152
7.2	Frequency Hold by Analog Input	153
7.3	Changing the Displayed Units (Hz↔Rpm).....	154
7.4	Setting Multi-Step Frequency.....	154
7.5	Command Source Configuration.....	157
7.5.1	The Keypad as a Command Input Device	157
7.5.2	The Terminal Block as a Command Input Device (Fwd/Rev run commands).....	158
7.5.3	The Terminal Block as a Command Input Device (Run and Rotation Direction Commands)	159
7.5.4	RS-485 Communication as a Command Input Device.....	160
7.6	Local/Remote Mode Switching.....	160
7.7	Forward or Reverse Run Prevention	162
7.8	Power-on Run.....	163

7.9	Reset and Restart	164
7.10	Setting Acceleration and Deceleration Times	165
7.10.1	Acc/Dec Time Based on Maximum Frequency	165
7.10.2	Acc/Dec Time Based on Operation Frequency	167
7.10.3	Multi-Step Acc/Dec Time Configuration	168
7.10.4	Configuring Acc/Dec Time Switch Frequency	169
7.11	Acc/Dec Pattern Configuration	171
7.12	Stopping the Acc/Dec Operation	174
7.13	V/F (Voltage/Frequency) Control	175
7.13.1	Linear V/F Pattern Operation	175
7.13.2	Square Reduction V/F Pattern Operation	176
7.13.3	User V/F Pattern Operation	177
7.14	Torque Boost	179
7.14.1	Manual Torque Boost	179
7.14.2	Auto Torque Boost	180
7.14.3	Advanced Auto Torque Boost	180
7.15	Output Voltage Setting	182
7.16	Start Mode Setting	183
7.16.1	Acceleration Start	183
7.16.2	Start After DC Braking	183
7.17	Stop Mode Setting	184
7.17.1	Deceleration Stop	184
7.17.2	Stop after DC Braking	185
7.17.3	Free Run Stop	186
7.17.4	Power Braking	187
7.18	Frequency Limit	188
7.18.1	Frequency Limit Using Maximum Frequency and Start Frequency	188
7.18.2	Frequency Limit Using Upper and Lower Limit Frequency Values	188
7.18.3	Frequency Jump	191
7.19	2 nd Operation Mode Setting	192
7.20	Multi-function Input Terminal Control	194
7.21	Expanded I/O Control with an Optional I/O Expansion Module	195
8	Learning Advanced Features	196
8.1	Operating with Auxiliary References	196
8.2	Jog Operation	201
8.2.1	Jog Operation 1-Forward Jog via Multi-function Terminal	201
8.2.2	Jog Operation 2-Forward/Reverse Jog via Multi-function Terminal	202
8.2.3	Jog Operation via Keypad Input	203

8.3	Up/down Operation	204
8.4	3-Wire Operation	208
8.5	Safe Operation Mode	209
8.6	Dwell Operation	210
8.7	Slip Compensation Operation	212
8.8	PID Control.....	215
8.8.1	PID Basic Operation	215
8.8.2	Pre-PID Operation	222
8.8.3	PID Sleep Mode.....	223
8.8.4	PID Switching (PID Openloop)	224
8.9	Auto Tuning	224
8.10	V/F Operation Using Speed Sensor	229
8.11	Sensorless-1 Vector Control	230
8.12	Sensorless-2 Vector Control	232
8.13	Vector Control Mode Operation	237
8.14	Torque Control	242
8.15	Droop Control	244
8.16	Speed / Torque Control Switching	244
8.17	Kinetic Energy Buffering	245
8.18	Energy Saving Operation	248
8.18.1	Manual Energy Saving Operation	248
8.18.2	Automatic Energy Saving Operation	249
8.19	Speed Search Operation	250
8.20	Auto Restart Settings	253
8.21	Operational Noise Settings (Carrier Frequency Settings)	255
8.22	2nd Motor Operation	258
8.23	Supply Power Transition	260
8.24	Cooling Fan Control	261
8.25	Input Power Frequency Settings.....	262
8.26	Input Power Voltage Settings	263
8.27	Read, Write, and Save Parameters	263
8.28	Parameter Initialization.....	264
8.29	Parameter Viewing and Lock Options	266
8.29.1	Parameter View Lock	266
8.29.2	Parameter Lock	267
8.29.3	Changed Parameter Display	268

8.30	User Group	268
8.31	Macro Selection	270
8.32	Easy Start.....	271
8.33	Config (CNF) Mode	272
8.34	Timer Settings	273
8.35	Traverse Operation	274
8.36	Brake Control	275
8.37	Multi-function Output On/Off Control	277
8.38	MMC function.....	278
8.38.1	Basic MMC Operation.....	280
8.38.2	Auto Change Operation	281
8.38.3	Interlock Operation.....	283
8.38.4	Bypass Operation (Regular Bypass).....	285
8.39	Press Regeneration Prevention (To evade control operation in the status of regeneration during press)	286
8.40	Anti-Hunting Regulator	287
8.41	Fire Mode	288
8.42	Dynamic Braking (DB) Resistor Operation Reference Voltage	290
8.43	kW/HP Unit Selection.....	290
8.44	Output Voltage Drop Prevention	291
9	Using Monitor Functions	292
9.1	Monitoring the Operating Status via the Keypad.....	292
9.1.1	Selecting Monitor Mode Display	292
9.1.2	Displaying Output Power.....	294
9.1.3	Selecting Load Speed Display	295
9.1.4	Selecting Hz/Rpm Display	295
9.1.5	Selecting Status Display	296
9.1.6	Monitoring Output Frequency.....	296
9.2	Monitoring Fault Status Using Keypad	297
9.2.1	Monitoring Current Fault Status.....	297
9.2.2	Monitoring Fault Trip History	298
9.3	Analog output	299
9.3.1	Voltage Output (0-10 V)	299
9.3.2	Current Output (4-20 mA)	301
9.3.3	Voltage Output (-10-+10V) Using an I/O Expansion Module	304
9.3.4	Current Output (4-20 mA/0-20 mA) Using an I/O Expansion Module	

		305
9.4	Relay Output and Multi-function Output Terminal Settings	306
9.5	Fault trip output using multi-function output terminals and relays....	312
9.6	Output Terminal Delay Time and Terminal Types	313
	9.6.1 Output Terminal Delay Time.....	313
	9.6.2 Setting the Output Terminal Type.....	313
9.7	Operation Time Monitor	314
9.8	Setting the Keypad Language	315
10	Using Protection Features.....	316
10.1	Motor Protection	316
	10.1.1 Electrothermal Motor Overheating Prevention (ETH).....	316
	10.1.2 Overload Early Warning and Trip	318
	10.1.3 Stall Prevention and Flux Braking	319
	10.1.4 Motor Overheat Sensor Input.....	323
10.2	Inverter and Sequence Protection	325
	10.2.1 Open-phase Protection	325
	10.2.2 External Trip Signal.....	326
	10.2.3 Inverter Overload Protection (IOLT)	327
	10.2.4 Keypad Command Loss	327
	10.2.5 Speed Command Loss.....	328
	10.2.6 Dynamic Braking (DB) Resistor Configuration	329
	10.2.7 Underload Warning and Failure.....	331
	10.2.8 Overspeed Fault.....	332
	10.2.9 Speed Deviation Fault.....	333
	10.2.10 Speed Sensor (Encoder) Fault Detection.....	333
	10.2.11 Fan Fault Detection	334
	10.2.12 Low Voltage Fault Trip	334
	10.2.13 Output Block via the Multi-Function Terminal.....	335
	10.2.14 Trip Status Reset	336
	10.2.15 Operation Mode On Optional Expansion Module Fault Trip.....	336
	10.2.16 No Motor Trip	337
	10.2.17 Low Voltage Fault Trip 2 During Operation	337
10.3	List of Faults and Warnings	339
11	Communication Function	342
11.1	Introduction.....	342
11.2	Specifications.....	343
11.3	Communication System Configuration	344
11.4	Basic Settings	345

11.5	Setting Operation Command and Frequency	346
11.6	Command Loss Protection	346
11.7	Setting Virtual Multi-Function inputs.....	347
11.8	Saving Parameters Defined by Communication	348
11.9	Communication Frame Monitoring.....	349
11.10	Special communication Area Settings	349
11.11	Parameter Group for Periodical Data Transmission.....	350
11.12	Parameter Group for Transmission of Macro Group and User Group at U&M Mode.....	352
11.13	Communication Protocol.....	353
11.13.1	LS INV 485 Protocol.....	353
11.13.2	Modbus-RTU protocol	358
11.13.3	iS7/iS5/iG5/iG5A Compatible Common Area Parameter	360
11.13.4	Expansion Common Area Parameter	364
12	Troubleshooting and Maintenance	377
12.1	Protection Functions.....	377
12.1.1	Protection from Output Current and Input Voltage	377
12.1.2	Abnormal Circuit Conditions and External Signals.....	378
12.1.3	Keypad and Optional Expansion Modules	380
12.2	Warning Messages.....	381
12.3	Troubleshooting Fault Trips	382
12.4	Replacing the Cooling Fan.....	385
12.4.1	Products Rated below 7.5 kW	385
12.4.2	Products Rated at 11-15 kW 200 V/400 V and 18.5-22 kW 400 V	386
12.4.3	Products Rated at more than 30 kW (200 V) / 90 kW (400 V), and 18.5-22 kW (200 V) / 30-75 kW (200/400 V).....	386
12.5	Daily and Regular Inspection Lists.....	387
13	Table of Functions	390
13.1	Parameter Mode – DRV Group (→DRV).....	390
13.2	Parameter Mode – Basic Function Group (→BAS)	393
13.3	Parameter Mode – Expansion Function Group (PAR→ADV).....	397
13.4	Parameter Mode – Control Function Group (→CON).....	401
13.5	Parameter Mode – Input Terminal Block Function Group (→IN)	407
13.6	Parameter Mode – Output Terminal Block Function Group (→OUT)	411
13.7	Parameter Mode – Communication Function Group (→COM)	415
13.8	Parameter Mode – Applied Function Group (→APP).....	418

13.9	Parameter Mode – Option Module Function Group (➔APO)	421
13.10	Parameter Mode – Protective Function Group (➔PRT).....	424
13.11	Parameter Mode – 2nd Motor Function Group (➔M2).....	427
13.12	Trip Mode (TRP Current (or Last-x))	428
13.13	Config Mode (CNF)	428
13.14	User/Macro Mode – Draw Operation Function Group➔MC1	431
13.15	User/Macro mode – Traverse Operation Function Group (➔MC2).....	432
14	Safety Funtion STO(Safe Torque Off)	433
14.1	Safety Standard Product	433
14.2	About the Safety Function	433
14.2.1	Safety Function Wiring Diagram	434
14.2.2	Installing the Safety Board to 0.75–160 kW Product.....	435
14.2.3	Installing the Safety Board to 185–375 kW Product.....	435
14.2.4	Safety Function Terminal Description	436
14.2.5	Cable Specification for Signal Terminal Block Wiring.....	436
15	Marine Certification	437
15.1	DNV (Det Norske Veritas) Marine Certification Details.....	437
15.2	Bureau Veritas (Marine & Offshore Division) Marine Certification Details	437
15.3	ABS Marine Certification Details.....	437
15.4	KR Marine Certification Details	438
15.5	Marine Certification Models for SV-iS7 Products.....	438
16	Using a Single Phase Power Source	440
16.1	Single Phase Rating.....	440
16.2	Power(HP), Input Current and Output Current.....	441
16.3	Input Frequency and Voltage Tolerance	442
16.4	Wiring and Peripheral Device	442
16.5	Other Considerations	445
17	Storage and Disposal	446
17.1	Storage	446
17.2	Disposal	446
	Product Warranty.....	450
	Index.....	453

MEMO

A large rectangular area with horizontal dotted lines, intended for writing a memo.

1 About the Product

This chapter provides details on product identification and part names. To install the inverter correctly and safely, carefully read and follow the instructions.

1.1 Preparing for Installation and Operation

1.1.1 Identifying the Product

Check the product name, open the packaging, and then confirm that the product is free from defects. Contact your supplier if you have any issues or questions about your product.

The iS7 inverter is manufactured in a range of product groups based on drive capacity and power source specifications. The product name and specifications are detailed on the rating plate. Check the rating plate before installing the product and make sure that the product meets your requirements.

About the Product

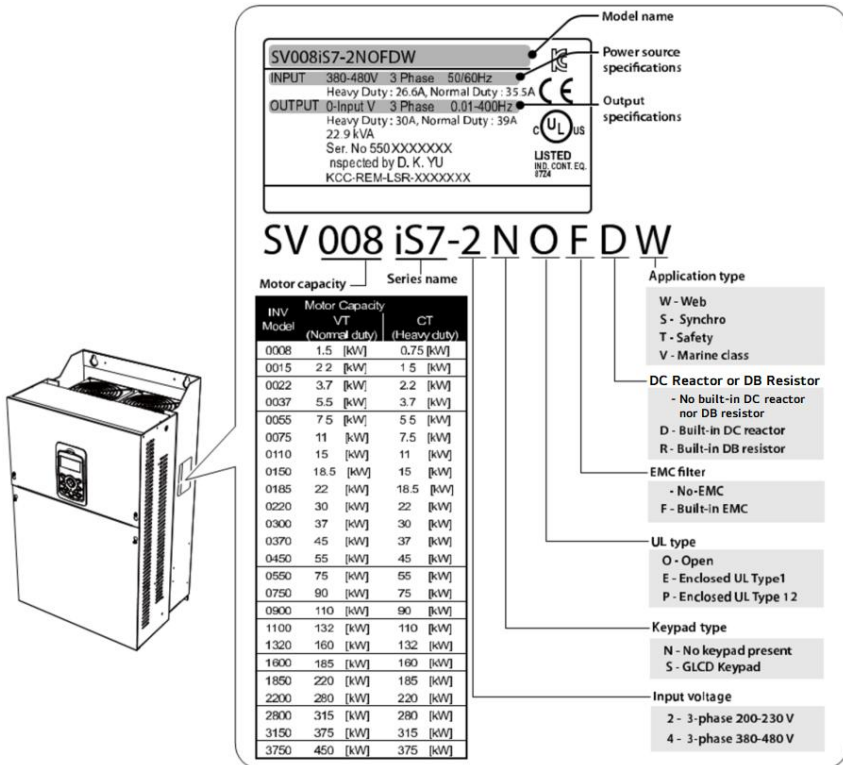

Model name
SV008iS7-2NOFDW

Power source specifications
INPUT 380-480V 3 Phase 50/60Hz
Heavy Duty : 26.6A, Normal Duty : 35.5A

Output specifications
OUTPUT 0-Input V 3 Phase 0.01-400Hz
Heavy Duty : 30A, Normal Duty : 39A
22.9 kVA
Ser. No 550XXXXXX
inspected by D. K. YU
KCC-REM-LSR-XXXXXX

Series name
SV 008 iS7-2 N O F D W

INV Model	Motor Capacity	
	VT (Normal duty)	CT (Heavy duty)
0008	1.5 [kW]	0.75 [kW]
0015	2.2 [kW]	1.5 [kW]
0022	3.7 [kW]	2.2 [kW]
0037	5.5 [kW]	3.7 [kW]
0055	7.5 [kW]	5.5 [kW]
0075	11 [kW]	7.5 [kW]
0110	15 [kW]	11 [kW]
0150	18.5 [kW]	15 [kW]
0185	22 [kW]	18.5 [kW]
0220	30 [kW]	22 [kW]
0300	37 [kW]	30 [kW]
0370	45 [kW]	37 [kW]
0450	55 [kW]	45 [kW]
0550	75 [kW]	55 [kW]
0750	90 [kW]	75 [kW]
0900	110 [kW]	90 [kW]
1100	132 [kW]	110 [kW]
1320	160 [kW]	132 [kW]
1600	185 [kW]	160 [kW]
1850	220 [kW]	185 [kW]
2200	280 [kW]	220 [kW]
2800	315 [kW]	280 [kW]
3150	375 [kW]	315 [kW]
3750	450 [kW]	375 [kW]

Application type
W - Web
S - Synchro
T - Safety
V - Marine class

DC Reactor or DB Resistor
- No built-in DC reactor nor DB resistor
D - Built-in DC reactor
R - Built-in DB resistor

EMC filter
- No-EMC
F - Built-in EMC

UL type
O - Open
E - Enclosed UL Type1
P - Enclosed UL Type 12

Keypad type
N - No keypad present
S - GLCD Keypad

Input voltage
2 - 3-phase 200-230 V
4 - 3-phase 380-480 V

Note1) Optional conduit parts are available for the Enclosed UL Type 1 models (0.75–75 kW products).

Note2) Optional built-in DCR is available for the Web application models (0.75–375 kW / type 2/4 products).

Note3) To use safety function, please buy 0.75-160kW product including safety option. However 185-375kW product users have to buy safety option and apply to standard products because safety option is not included.

1.1.2 Checking the Product for Defects or Damage

If you suspect that the product has been mishandled or damaged in any way, contact the LS ELECTRIC Customer Support center with the phone numbers listed on the back cover of this manual.

1.1.3 Preparing the Product for Installation and Operation

Preparation steps for installation and operation may slightly vary by product type and application. Refer to the manual and prepare the product accordingly.

1.1.4 Installing the Product

Refer to the installation section of this manual and install the product correctly considering the installation and operating conditions at the installation location, such as installation clearances, to prevent premature deterioration or performance loss.

1.1.5 Connecting the Cables

Connect the power input/output and signal cables to the terminal block according to the instructions provided in this manual. Ensure that all the cables are connected correctly before supplying power to the product. Incorrect cable connections may damage the product.

1.2 Part Names

The illustration below displays part names. Details may vary between product groups.

1.2.1 Interior and Exterior View (IP 21 Model Types Less than 22 kW [200 V] / Less than 75 kW [400 V])

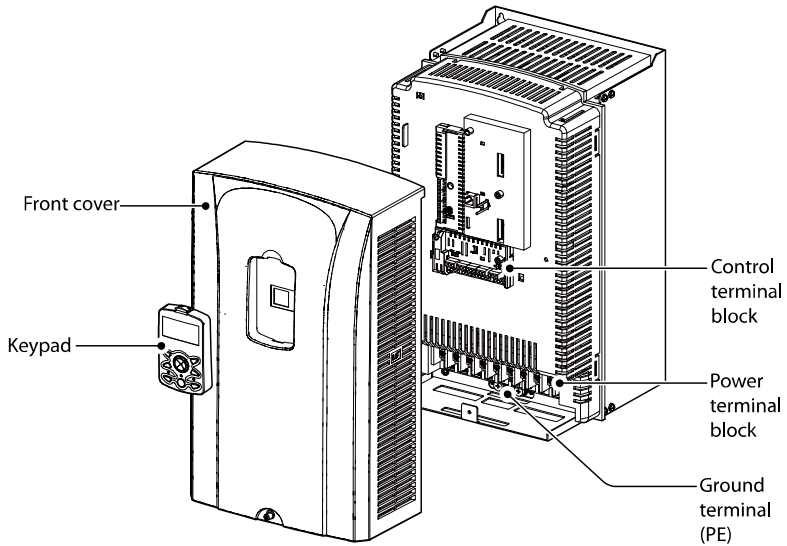

1.2.2 Interior and Exterior View (IP 54 Model Types Less than 22 kW [200/400 V])

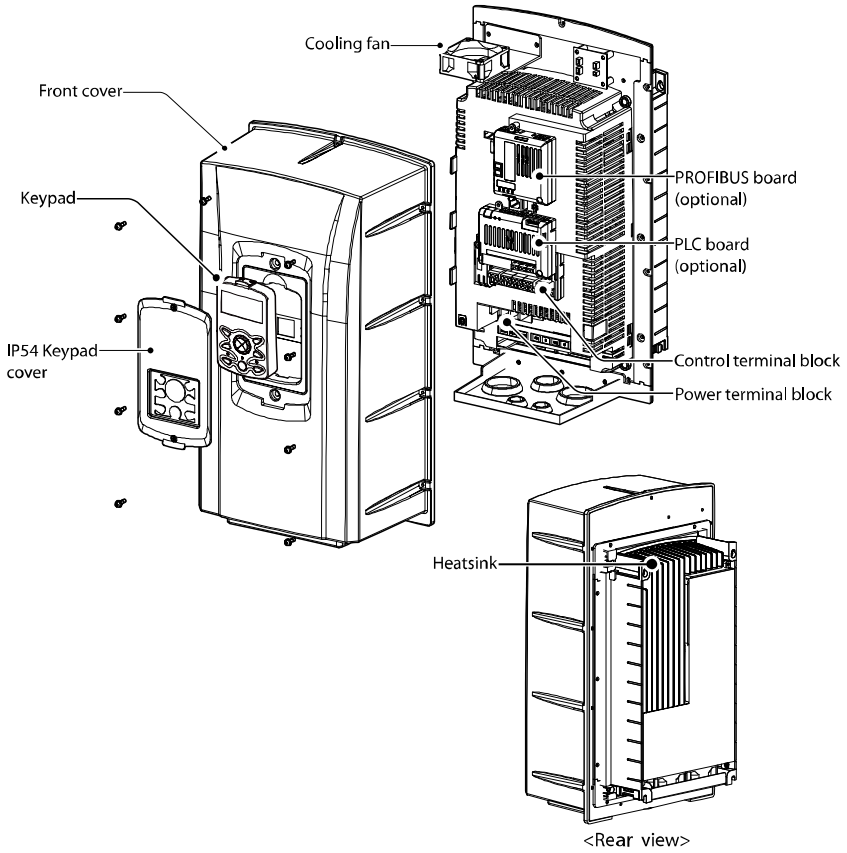

1.2.3 Interior and Exterior View (Model Types 30 kW and up [200 V] / 90 kW and up [400 V])

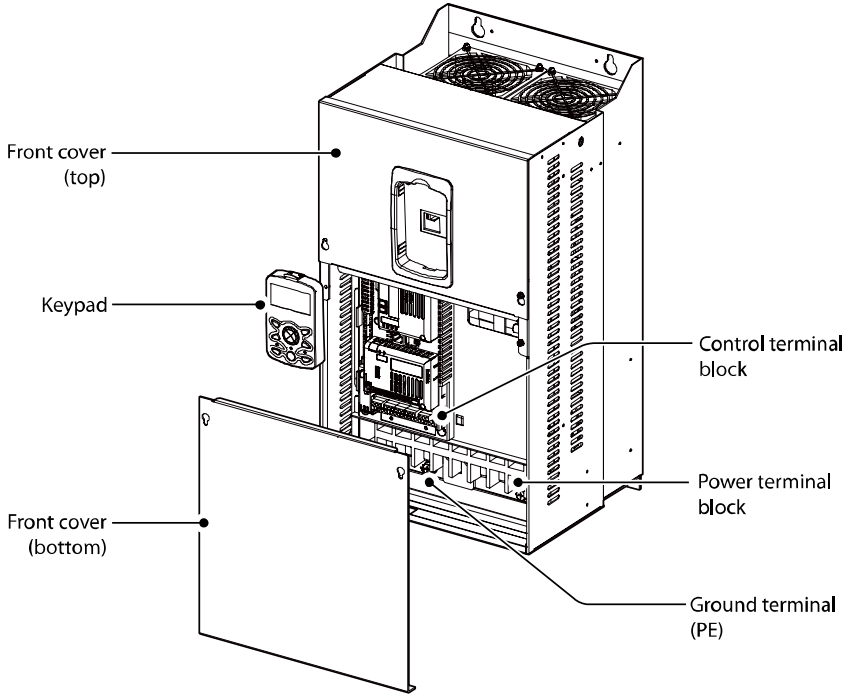

Note

Refer to the installation manual provided with the optional module products before installing communication modules in the inverter.

2 Technical Specifications

2.1 Input and Output Specifications 200 V Class (0.75–22 kW)

Model SV xxx iS7-2x			0008	0015	0022	0037	0055	0075	0110	0150	0185	0220	
Applied Motor	Normal load	HP	2	3	5	7.5	10	15	20	25	30	40	
		kW	1.5	2.2	3.7	5.5	7.5	11	15	18.5	22	30	
	Heavy load	HP	1	2	3	5	7.5	10	15	20	25	30	
		kW	0.75	1.5	2.2	3.7	5.5	7.5	11	15	18.5	22	
Rated output	Rated Capacity (kVA)		1.9	3.0	4.5	6.1	9.1	12.2	17.5	22.9	28.2	33.5	
	Rated Current (A)	Normal load	8	12	16	24	32	46	60	74	88	124	
		Heavy load	5	8	12	16	24	32	46	60	74	88	
	Output Frequency		0–400 Hz (Sensorless-1: 0–300 Hz, Sensorless-2, Vector: 0.1–120 Hz)										
	Output Voltage (V)		3-Phase 200–230 V										
Rated input	Working Voltage (V)		3-Phase 200–230 VAC (-15%–+10%)										
	Input Frequency		50–60 Hz (±5%)										
	Rated Current (A)	Normal load	6.8	10.6	14.9	21.3	28.6	41.2	54.7	69.7	82.9	116.1	
		Heavy load	4.3	6.9	11.2	14.9	22.1	28.6	44.3	55.9	70.8	85.3	

- Only the heavy duty ratings apply to model types without a built-in DC resistor (NON-DCR).
- The standard used for 200 V inverters is based on a 220 V supply voltage.
- The rated output current is limited based on the carrier frequency set at CON-04.
- The output frequency is limited to 0-300 Hz if DRV-09 (control mode) is set to “3 (Sensorless-1),” and to 0-120 Hz if DRV-09 (control mode) is set to “4 (Sensorless-3).”
- The maximum output voltage cannot exceed the input voltage of the power source.

2.2 Input and Output Specifications 200 V Class (30–75 kW)

Model SV xxx iS7-2x			0300	0370	0450	0550	0750					
Applied Motor	Normal load	HP	50	60	75	100	125					
		kW	37	45	55	75	90					
	Heavy load	HP	40	50	60	75	100					
		kW	30	37	45	55	75					
Rated output	Rated Capacity (kVA)		46	57	69	84	116					
	Rated Current (A)	Normal load	146	180	220	288	345					
		Heavy load	116	146	180	220	288					
	Output Frequency		0–400 Hz (Sensorless-1: 0–300 Hz, Sensorless-2, Vector: 0.1–120 Hz)									
	Output Voltage (V)		3-Phase 200–230 V									
Rated input	Working Voltage (V)		3-Phase 200–230 VAC (-15%–+10%)									
	Input Frequency		50–60 Hz (±5%)									
	Rated Current (A)	Normal load	152	190	231	302	362					
		Heavy load	121	154	191	233	305					

- The standard motor capacity is based on a standard 4-pole motor.
- The standard used for 200 V inverters is based on a 200 V supply voltage.
- The rated output current is limited based on the carrier frequency set at CON-04.
- The output frequency is limited to 0-300 Hz if DRV-09 (control mode) is set to “3 (Sensorless-1),” and to 0-120 Hz if DRV-09 (control mode) is set to “4 (Sensorless-3).”
- The maximum output voltage cannot exceed the input voltage of the power source.

2.3 Input and Output Specifications 400 V Class (0.75–22 kW)

Model SV xxx iS7-2x			0008	0015	0022	0037	0055	0075	0110	0150	0185	0220	
Applied Motor	Normal load	HP	2	3	5	7.5	10	15	20	25	30	40	
		kW	1.5	2.2	3.7	5.5	7.5	11	15	18.5	22	30	
	Heavy load	HP	1	2	3	5	7.5	10	15	20	25	30	
		kW	0.75	1.5	2.2	3.7	5.5	7.5	11	15	18.5	22	
Rated output	Rated Capacity (kVA)		1.9	3.0	4.5	6.1	9.1	12.2	18.3	22.9	29.7	34.3	
	Rated Current (A)	Normal load	4	6	8	12	16	24	30	39	45	61	
		Heavy load	2.5	4	6	8	12	16	24	30	39	45	
	Output Frequency		0–400 Hz (Sensorless-1: 0–300Hz, Sensorless-2, Vector: 0.1–120Hz)										
	Output Voltage (V)		3-Phase 380–480 V										
Rated input	Working Voltage (V)		3-Phase 380–480 VAC (-15%–+10%)										
	Input Frequency		50–60 Hz (±5%)										
	Rated Current (A)	Normal load	3.7	5.7	7.7	11.1	14.7	21.9	26.4	35.5	41.1	55.7	
		Heavy load	2.2	3.6	5.5	7.5	11.0	14.4	22.0	26.6	35.6	41.6	

- Only the heavy duty ratings apply to model types without a built-in DC resistor (NON- DCR).
- The standard motor capacity is based on a standard 4-pole motor.
- The standard used for 400 V inverters is based on a 440 V supply voltage.
- The rated output current is limited based on the carrier frequency set at CON-04.
- The output frequency is limited to 0-300 Hz if DRV-09 (control mode) is set to “3 (Sensorless-1),” and to 0-120 Hz if DRV-09 (control mode) is set to “4 (Sensorless-3).”
- The maximum output voltage cannot exceed the input voltage of the power source.

2.4 Input and Output Specifications 400 V Class (30–160 kW)

Model SV xxx iS7-4x			0300	0370	0450	0550	0750	0900	1100	1320	1600	
Applied Motor	Normal load	HP	50	60	75	100	125	150	200	250	300	
		kW	37	45	55	75	90	110	132	160	185	
	Heavy load	HP	40	50	60	75	100	125	150	200	250	
		kW	30	37	45	55	75	90	110	132	160	
Rated output	Rated Capacity (kVA)		46	57	69	84	116	139	170	201	248	
	Rated Current (A)	Normal load	75	91	110	152	183	223	264	325	370	
		Heavy load	61	75	91	110	152	183	223	264	325	
	Output Frequency		0–400 Hz (Sensorless-1: 0–300 Hz, Sensorless-2, Vector: 0.1–120 Hz)									
	Output Voltage (V)		3-Phase 380–480 V									
Rated input	Working Voltage (V)		3-Phase 380–480 VAC (-15%–+10%)									
	Input Frequency		50–60 Hz (±5%)									
	Rated Current (A)	Normal load	67.5	81.7	101.8	143.6	173.4	212.9	254.2	315.3	359.3	
		Heavy load	55.5	67.9	82.4	102.6	143.4	174.7	213.5	255.6	316.3	

- The standard used for 400 V inverters is based on a 440 V supply voltage.
- The rated output current is limited based on the carrier frequency set at CON-04.
- The output frequency is limited to 0-300 Hz if DRV-09 (control mode) is set to "3 (Sensorless-1)," and to 0-120 Hz if DRV-09 (control mode) is set to "4 (Sensorless-3)."
- The maximum output voltage cannot exceed the input voltage of the power source.

2.5 Input and Output Specifications 400 V Class (185–375 kW)

Model SV xxx iS7-4x			1850	2200	2800	3150	3750					
Applied Motor	Normal load	HP	350	400	500	-	-					
		kW	220	280	315	375	450					
	Heavy load	HP	300	350	400	500	-					
		kW	185	220	280	315	375					
Rated output	Rated Capacity (kVA)		286	329	416	467	557					
	Rated Current (A)	Normal load	432	547	613	731	877					
		Heavy load	370	432	547	613	731					
	Output Frequency		0–400 Hz (Sensorless-1: 0–300 Hz, Sensorless-2, Vector: 0–120 Hz)									
	Output Voltage (V)		3-Phase 380–480 V									
Rated input	Working Voltage (V)		3-Phase 380–480 VAC (-15%–+10%)									
	Input Frequency		50–60 Hz (±5%)									
	Rated Current (A)	Normal load	463	590	673	796	948					
		Heavy load	404	466	605	674	798					

- The standard motor capacity is based on a standard 4-pole motor.
- The standard used for 400 V inverters is based on a 440 V supply voltage.
- The rated output current is limited based on the carrier frequency set at CON-04.
- The output frequency is limited to 0–300 Hz if DRV-09 (control mode) is set to “3 (Sensorless-1),” and to 0–120 Hz if DRV-09 (control mode) is set to “4 (Sensorless-3).”
- The maximum output voltage cannot exceed the input voltage of the power source.

Note

[English]

The maximum allowed prospective short-circuit current at the input power connection is defined in IEC 60439-1 as 100 kA. The drive is suitable for use in a circuit capable of delivering not more than 100 kA RMS at the drive's maximum rated voltage, depending on the selected MCCB. RMS symmetrical amperes for recommended MCCB are the following table.

[French]

Le courant maximum de court-circuit présumé autorisé au connecteur d'alimentation électrique est défini dans la norme IEC 60439-1 comme égal à 100 kA. L'entraînement convient pour une utilisation dans un circuit capable de délivrer pas plus de 100 kA RMS à la tension nominale maximale de l'entraînement. Le tableau suivant indique le MCCB recommandé selon le courant RMS symétrique en ampères.

Working Voltage	UTE100 (E/N)	UTS150 (N/H/L)	UTS250 (N/H/L)	UTS400 (N/H/L)		
240V(50/60Hz)	50/65kA	65/100/150kA	65/100/150kA	65/100/150kA		
480V(50/60Hz)	25/35kA	35/65/100kA	35/65/100kA	35/65/100kA		
Working Voltage	ABS33c	ABS53c	ABS63c	ABS103c	ABS203c	ABS403c
240V(50/60Hz)	30kA	35kA	35kA	85kA	85kA	75kA
480V(50/60Hz)	7.5kA	10kA	10kA	26kA	26kA	35kA

2.6 Product Specification Details

2.6.1 Control

Items		Description
Control	Control modes	V/F control, V/F PG, slip compensation, sensorless vector-1, sensorless vector-2, vector control
	Frequency settings resolution	Digital command: 0.01 Hz Analog command: 0.06 Hz (maximum frequency: 60 Hz)
	Frequency accuracy	Digital command: 0.01% of maximum output frequency Analog command: 0.1% of maximum output frequency
	V/F pattern	Linear, square reduction, user V/F
	Overload capacity	Rated current for heavy duty operation: 150% for 1 min Rated current for normal duty operation: 110% for 1 min
	Torque boost	Manual torque boost, automatic torque boost

- Only the heavy load ratings apply to 0.75-22 kW model types without a built-in DC resistor (NON-DCR).

2.6.2 Operation

Items		Description
Operation	Operation types	Select from keypad, terminal strip, or network communication operation.
	Frequency settings	Analog type: -10~10 V, 0~10 V, 0~20 mA Digital type: keypad
	Operation function	<ul style="list-style-type: none"> • PID control • 3-wire operation • Frequency limit • Second function • Reverse rotation prevention • Inverter bypass • Flying start • Power braking • Up-down operation • DC braking • Frequency jump • Slip compensation • Automatic restart • Automatic tuning • Energy buffering • Flux braking

Technical Specifications

Items		Description	
		<ul style="list-style-type: none"> Leakage reduction Easy start MMC 	
Input	Multi-function terminal (8 EA) P1–P8*	Select NPN (Sink) or PNP (Source) mode.	
		<ul style="list-style-type: none"> Forward direction operation Reset Emergency stop Multi-step speed frequency-high/med/low DC braking during stop Frequency increase 3-wire operation Acceleration/deceleration/stop Operation by keypad input during an operation by network communication Reverse direction operation External trip Jog operation Multi-step acc/dec-high/med/low Second motor selection Frequency reduction Transition from PID to general operation Analog command frequency fix 	
Output	Multi-function open collector terminal	Fault output and inverter operation status output	Less than DC 26 V, 100 mA
	Multi-function relay terminal		N.O.: Less than AC 250 V 1A, DC 30 V, 3A N.C.: Less than AC 250 V 1A, DC 30 V 1A
	Analog output	DC 0–10 V, 0–20 mA: Select output type from frequency, current, voltage, or DC voltage.	

* Set the Input Group codes IN-65 through IN-72 to configure the multi-function terminal functions.

2.6.3 Protection Function

Items		Description
Protection function	Trips	<ul style="list-style-type: none"> Over voltage Low voltage Over current Earth current detection Inverter overheat Motor overheat Output imaging Overload protection Network communication error Lost command Hardware failure Cooling fan failure Pre-PID failure No motor trip External trip Other safety functions
	Alarms	<ul style="list-style-type: none"> Stall prevention Overload Light load Encoder error Fan failure Keypad command loss Speed command loss
	Instantaneous blackout	<p>Less than 15 ms (CT) [Less than 8 ms (VT)]: Continue operation (must be within the rated input voltage and rated output range).</p> <p>Over 15 ms (CT) [Over 8 ms (VT)]: Automatically restart</p>

2.6.4 Structure and Operating Environment Control

Items		Description
Structure/ operating environment	Cooling type	<p>Forced cooling: 0.75–15 kW (200/400 V class), 22 kW (400 V class)</p> <p>Inhalation cooling: 22–75 kW (200 V class), 30–375 kW (400 V class)</p>
	Protection structure	<p>- 0.75–22 kW (200V), 0.75–75 kW (400 V): Open type IP 21 (default), UL enclosed type 1 (optional)*</p> <p>- 30–75 kW (200 V), 90–375 kW (400 V): Open type IP 00</p> <p>- 0.75–22 kW, frame types 2, 4 and others.: Enclosed IP54 type, UL enclosed type 12</p>
	Ambient temperature	<ul style="list-style-type: none"> CT load (heavy duty): -10–50°C VT load (normal duty): -10–40°C

Technical Specifications

Items	Description
	<ul style="list-style-type: none"> - No ice or frost should be present. - Working under normal load at 50°C (122°F), it is recommended that less than 80% load is applied. <ul style="list-style-type: none"> • IP54 product: -10–40°C - No ice or frost should be present.
Storage temperature.	-20°C–65°C (-4–149°F)
Ambient humidity	Relative humidity less than 95% RH (to prevent condensation from forming)
Operation altitude	Maximum 1000m above sea level for standard operation. From 1000 to 4000m, the rated input voltage and rated output current of the drive must be derated by 1% for every 100m.
Oscillation	Less than 5.9 m/sec ² (0.6 G).
Surrounding environment	Prevent contact with corrosive gases, inflammable gases, oil stains, dust, and other pollutants (Pollution Degree 2 Environment).

* UL Enclosed type 1 when an optional conduit box is installed. The 30–75 kW (200 V class) product is regarded as UL Open type IP 20 when an optional conduit box is installed.

3 Installing the Inverter

3.1 Installation Considerations

Inverters are composed of various precision electronic devices, and therefore the installation environment can significantly impact the lifespan and reliability of the product. The table below details the ideal operation and installation conditions for the inverter.

Items	Description
Ambient Temperature*	CT load (heavy duty): -10°C–50°C VT load (normal duty): -10°C–40°C IP54 model types: -10°C–40°C
Ambient Humidity	90% relative humidity (no condensation)
Storage Temperature	- 4–149°F (-20–65°C)
Environmental Factors	An environment free from corrosive or flammable gases, oil residue, or dust (pollution degree 2)
Altitude/Vibration	Lower than 3,280 ft (1,000 m) above sea level/less than 0.6 G (5.9 m/sec ²)
Air Pressure	70–106 kPa

*The ambient temperature is the temperature measured at a point 2" (5 cm) from the surface of the inverter. No ice or frost should be present.

⚠ Caution

- Do not transport the inverter by lifting with the inverter's covers or plastic surfaces. The inverter may tip over if covers break, causing injuries or damage to the product. Always support the inverter using the metal frames when moving it.
- Hi-capacity inverters are very heavy and bulky. Use an appropriate transport method that is suitable for the weight. Do not place heavy objects on top of electric cables. Doing so may damage the cable and result in an electric shock.
- Do not install the inverter on the floor or mount it sideways against a wall. The inverter must be installed vertically, on a wall or inside a panel, with its rear flat on the mounting surface.

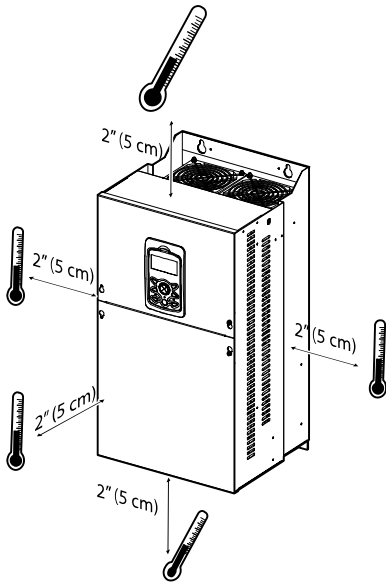

⚠ Caution

Do not allow the ambient temperature to exceed the allowable range while operating the inverter.

3.2 Selecting and Preparing a Site for Installation

When selecting an installation location, consider the following requirements:

- The inverter must be installed on a wall that can support the inverter's weight.
- The location must be free from vibration. Vibrations can adversely affect the operation of the inverter.
- The inverter can become very hot during operation. Install the inverter on a surface that is fire resistant or flame retardant with sufficient clearance around the inverter to allow for air circulation. The illustrations below detail the required installation clearances.

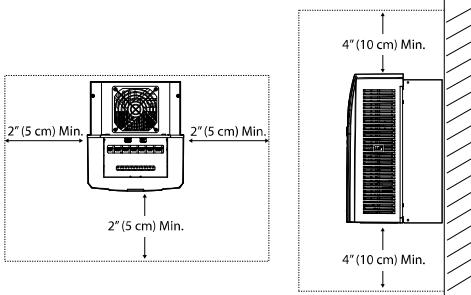

<Clearance requirements for model types with less than 30 kW capacity>

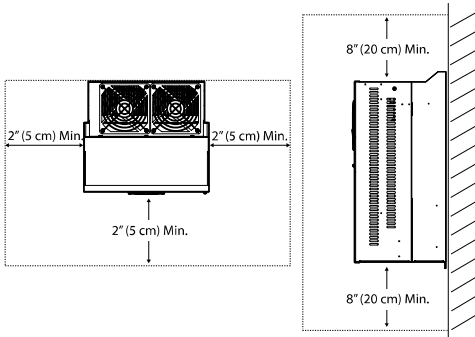

<Clearance requirements for model types with more than 30 kW capacity>

⚠ Caution

Install the inverter on a non-flammable surface, and do not place flammable material near the inverter. Otherwise, a fire may result.

Note

Model types with capacities of 30 kW or more require a minimum of 8" clearance above and below the unit.

Installing the Inverter

- Ensure that the cable conduits do not obstruct the air flow to and from the cooling fan.

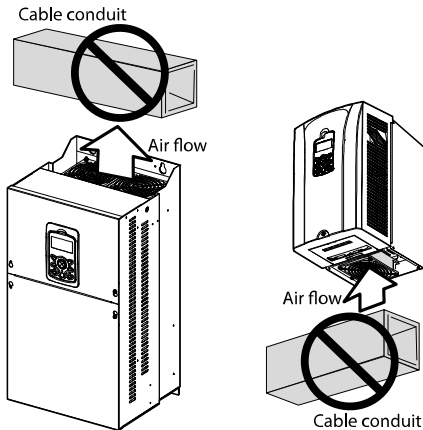

- Ensure sufficient air circulation is provided around the inverter when it is installed. If the inverter is to be installed inside a panel, enclosure, or cabinet rack, carefully consider the position of the inverter's cooling fan and vents. The cooling fan must be positioned to efficiently dissipate the heat generated by the operation of the inverter.

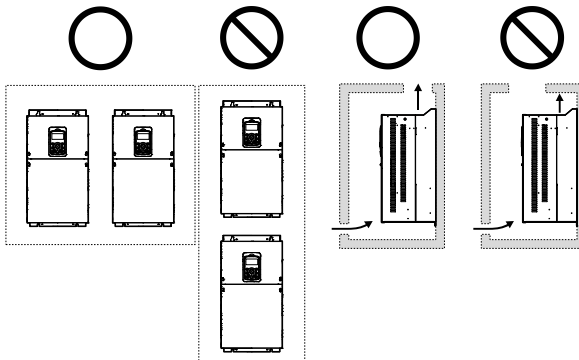

Note

In order to meet EMC standards, 200 V, 30–75 kW model types and model types with capacities of 90 kW or more should be installed inside a metal cabinet.

- If you are installing multiple inverters of different ratings, provide sufficient clearance to meet the clearance specifications of the larger inverter. The iS7 inverters rated for up to 30 kW may be installed side by side.

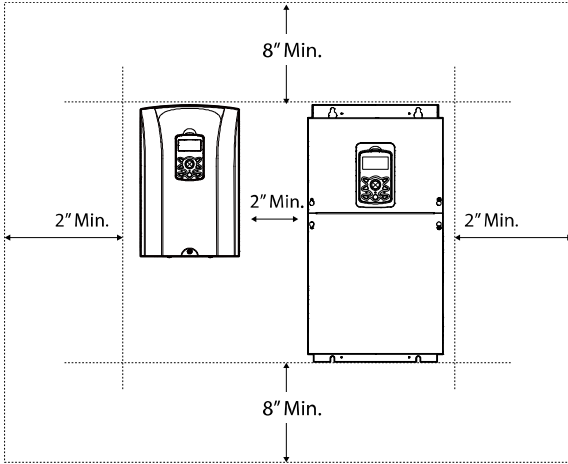

3.3 Exterior and Dimensions (UL Enclosed Type 1, IP21 Type)

SV0008-0037iS7 (200 V/400 V)

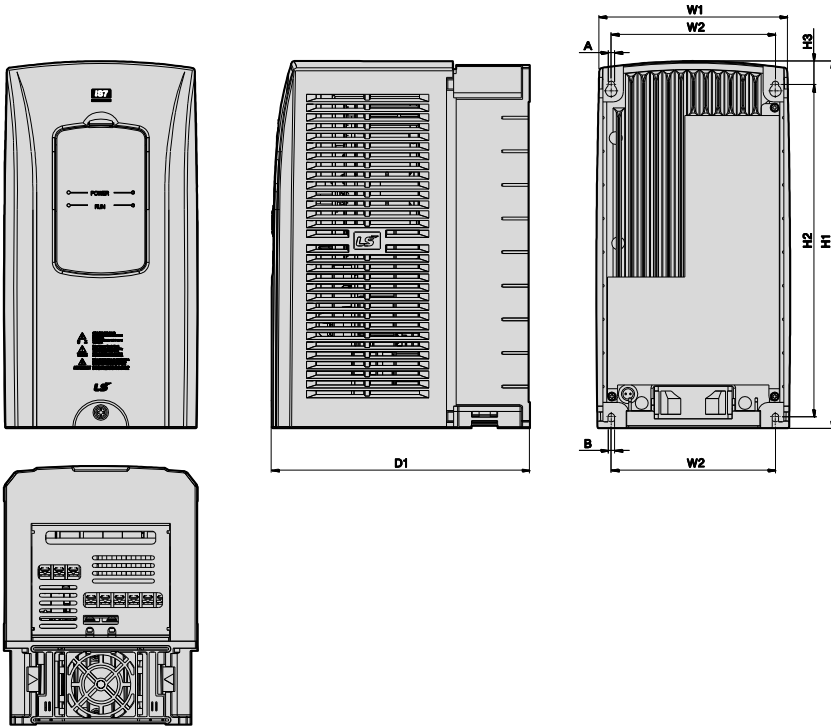

Units: mm (inch)

Inverter Capacity	W1	W2	H1	H2	H3	D1	A	B
SV0008-0037 iS7 - 2/4	150 (5.90)	127 (5.00)	284 (11.18)	257 (10.11)	18 (0.70)	200 (7.87)	5 (0.19)	5 (0.19)

SV0055-0075iS7 (200 V/400 V)

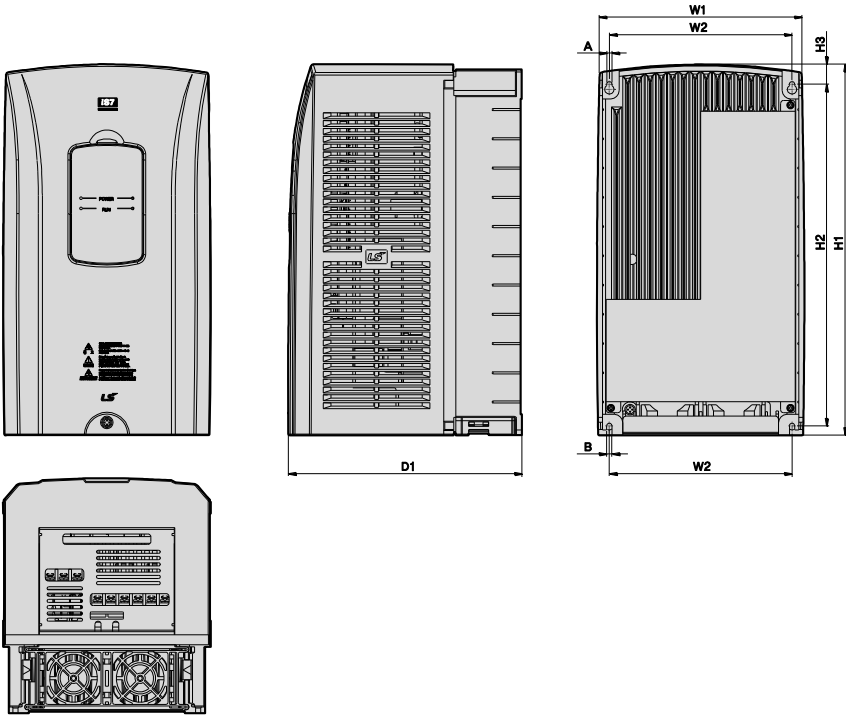

Installing
the Inverter

Units: mm (inch)

Inverter Capacity	W1	W2	H1	H2	H3	D1	A	B
SV0055-0075 iS7 - 2/4	200 (7.87)	176 (6.92)	355 (13.97)	327 (12.87)	19 (0.74)	225 (8.85)	5 (0.19)	5 (0.19)

Installing the Inverter

SV0110-0150iS7 (200 V/400 V)

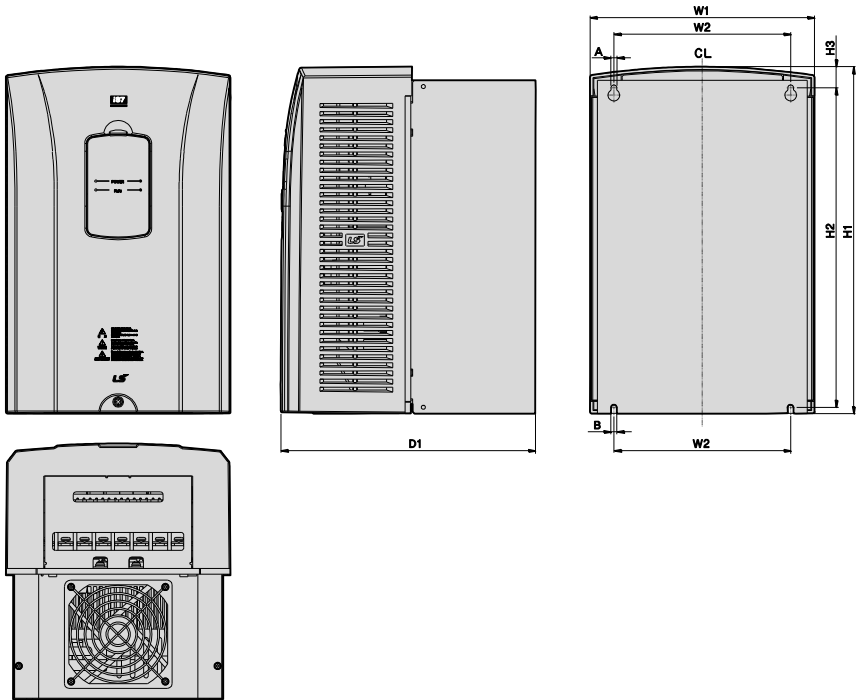

Units: mm (inch)

Inverter Capacity	W1	W2	H1	H2	H3	D1	A	B
SV0110-0150 iS7- 2/4	250 (9.84)	214.6 (8.44)	385 (15.15)	355 (13.97)	23.6 (0.92)	284 (11.18)	6.5 (0.25)	6.5 (0.25)

SV0185-0220iS7 (200 V/400 V)

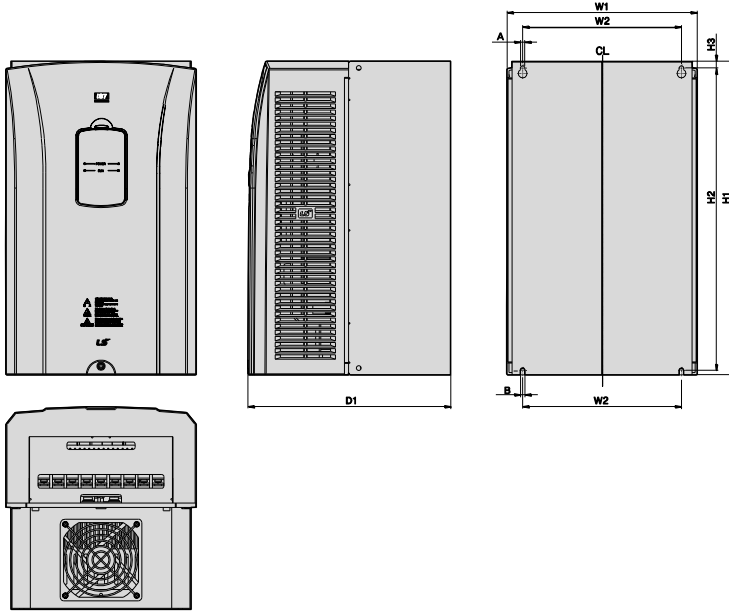

Units: mm (inch)

Inverter Capacity	W1	W2	H1	H2	H3	D1	A	B
SV0185-0220iS7- 2/4	280 (11.02)	243.5 (9.58)	461.6 (18.17)	445 (17.51)	10.1 (0.39)	298 (11.73)	6.5 (0.25)	6.5 (0.25)

SV0300-iS7 (200 V, IP00 Type)

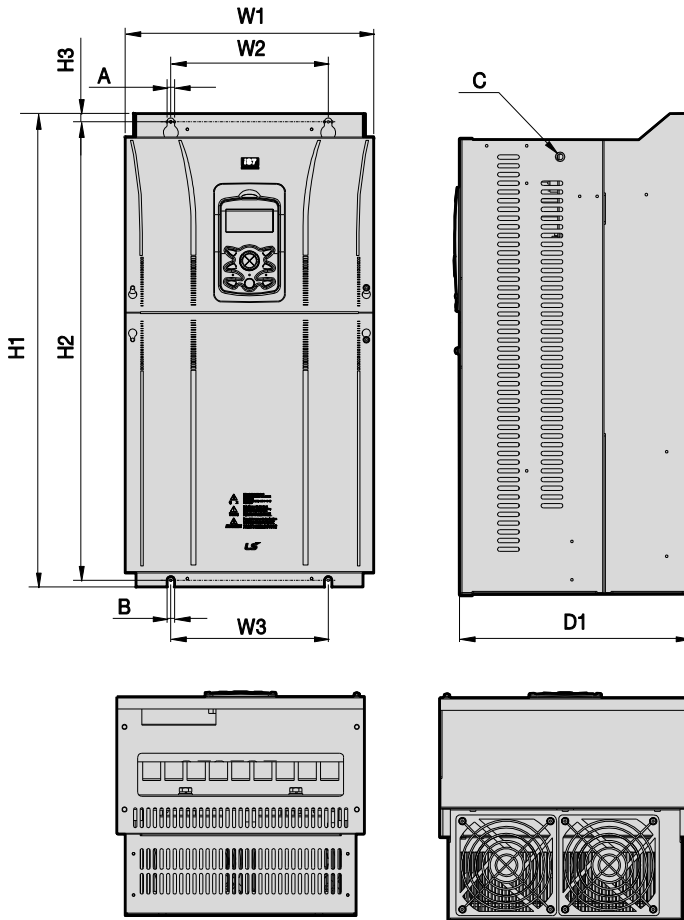

Units: mm (inch)

Inverter Capacity	W1	W2	W3	H1	H2	H3	D1	A	B	C
SV0300 iS7-2	300 (11.81)	190 (7.48)	190 (7.48)	570 (22.44)	552 (21.73)	10 (0.39)	265.2 (10.44)	10 (0.39)	10 (0.39)	M8

SV0370-0450iS7 (200 V, IP00 Type)

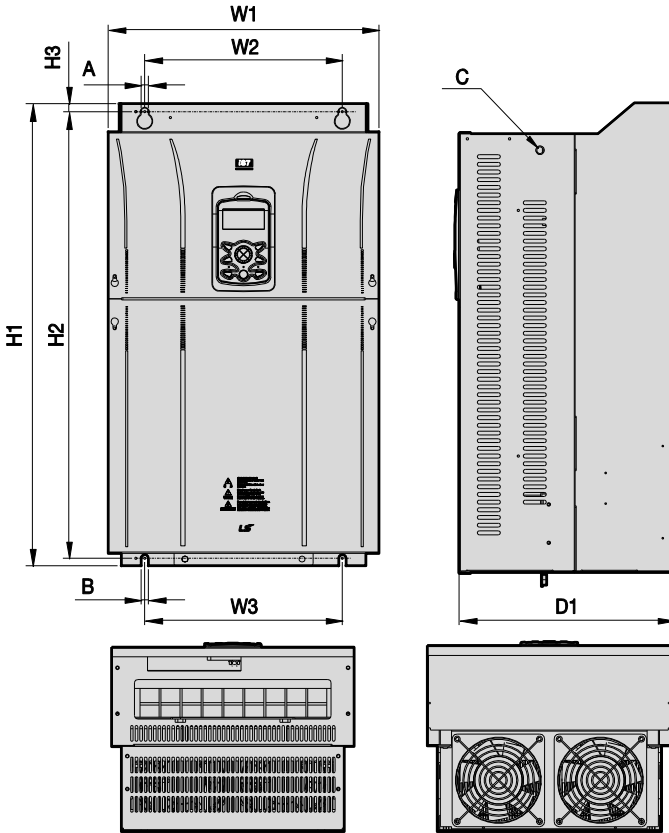

Installing
the Inverter

Units: mm (inch)

Inverter Capacity	W1	W2	W3	H1	H2	H3	D1	A	B	C
SV0370-0450 iS7-2	370 (14.56)	270 (10.63)	270 (10.63)	630 (24.8)	609 (23.97)	11 (0.43)	281.2 (11.07)	10 (0.39)	10 (0.39)	M10

Installing the Inverter

SV0300-0450iS7 (400 V)

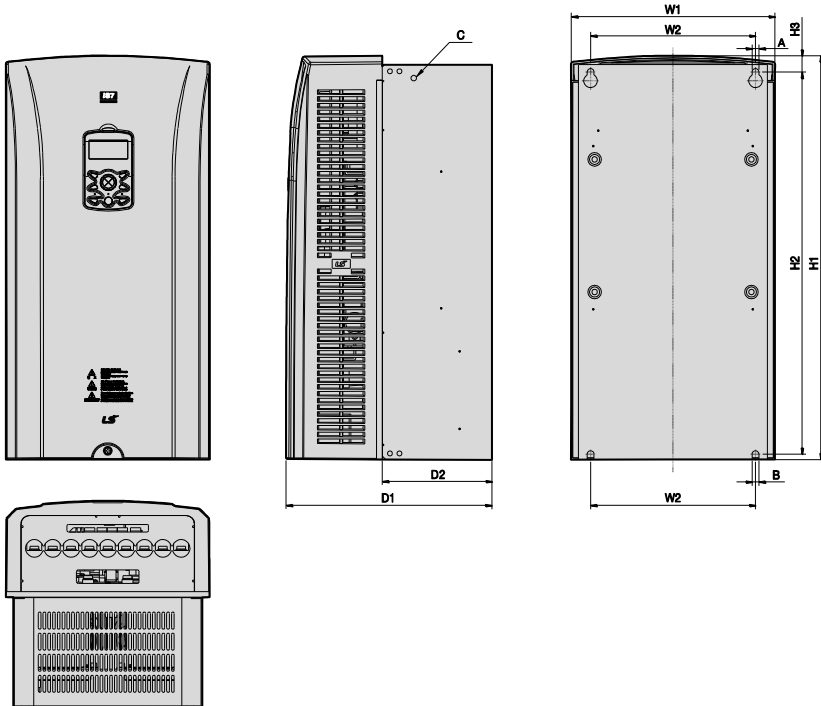

Units: mm (inch)

Inverter Capacity	W1	W2	H1	H2	H3	D1	D2	A	B	C
SV0300-0450 iS7-4	300.1 (11.81)	242.8 (9.55)	594.1 (23.38)	562 (22.12)	24.1 (0.94)	DCR type		10 (0.39)	10 (0.39)	M8
						303.2 (11.93)	161 (6.33)			
						Non-DCR type				
						271.2 (10.67)	129 (5.78)			

SV0550-0750iS7 (200 V, IP00 Type)

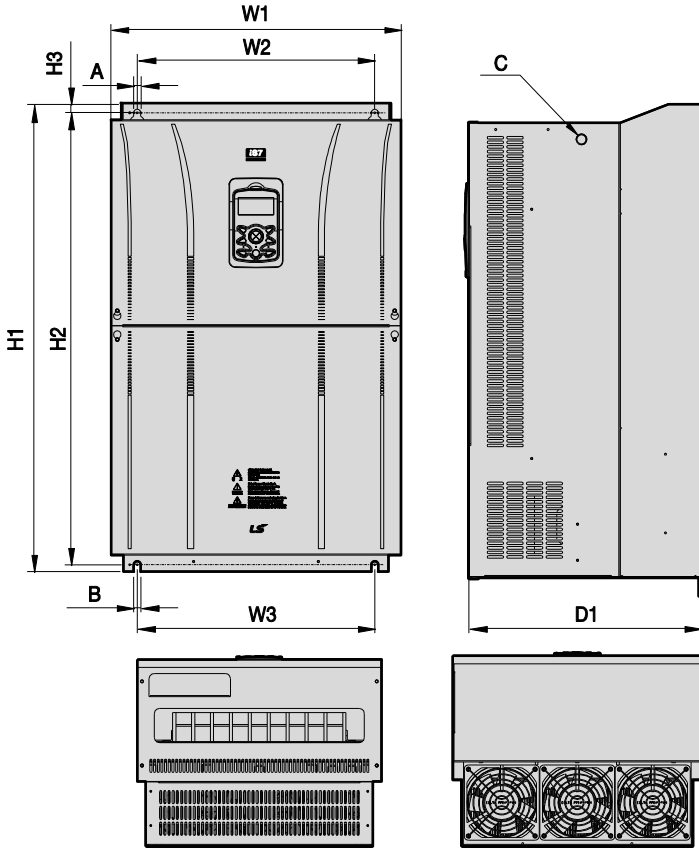

Installing
the Inverter

Units: mm (inch)

Inverter Capacity	W1	W2	W3	H1	H2	H3	D1	A	B	C
SV0550-0750 iS7-2	465 (18.3)	381 (15.0)	381 (15.0)	750 (29.52)	723.5 (28.48)	15.5 (0.61)	355.6 (14.0)	11 (0.43)	11 (0.43)	M16

Installing the Inverter

SV0550-0750iS7 (400 V)

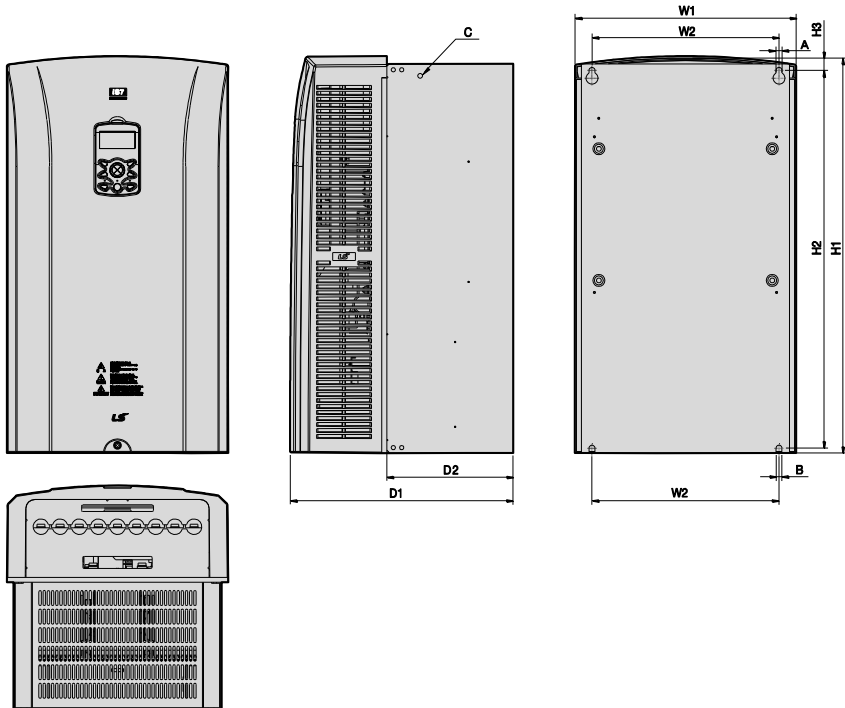

Units: mm (inch)

Inverter	W1	W2	H1	H2	H3	D1	D2	A	B	C
SV0550-0750 iS7-4	370.1 (14.57)	312.8 (12.31)	663.5 (26.12)	631.4 (24.85)	24.1 (0.94)	DCR type		10 (0.39)	10 (0.39)	M8
						373.3 (14.69)	211.5 (8.32)			
						Non-DCR type				
						312.4 (12.29)	150.6 (5.92)			

SV0900-1100iS7 (400 V, IP00 Type)

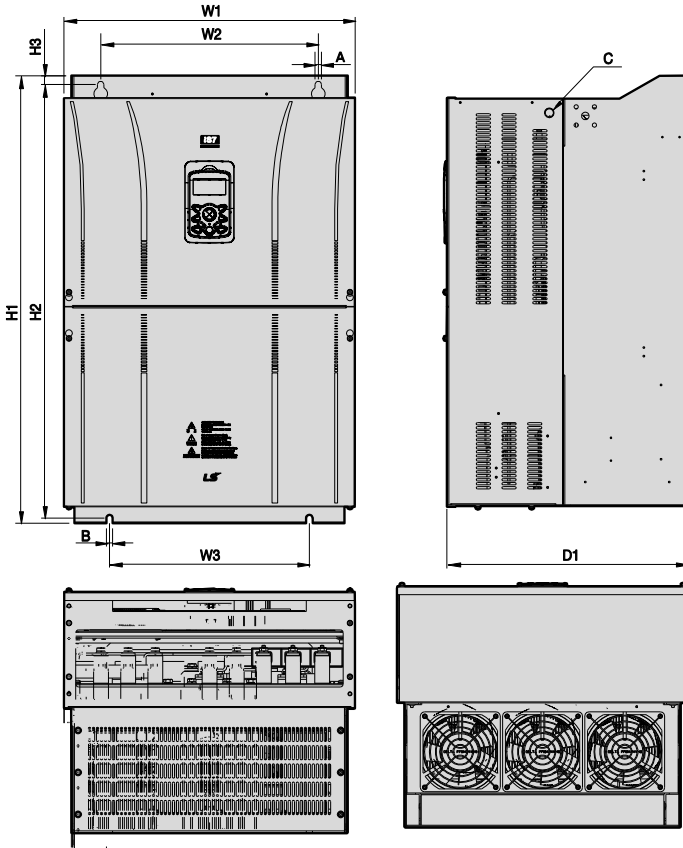

Units: mm (inch)

Inverter Capacity	W1	W2	W3	H1	H2	H3	D1	A	B	C
SV0900-1100 iS7-4	510 (20.07)	381 (15.0)	350 (13.77)	783.5 (30.84)	759 (29.88)	15.5 (0.61)	422.6 (16.63)	11 (0.43)	11 (0.43)	M16

SV1320-1600iS7 (400 V, IP00 Type)

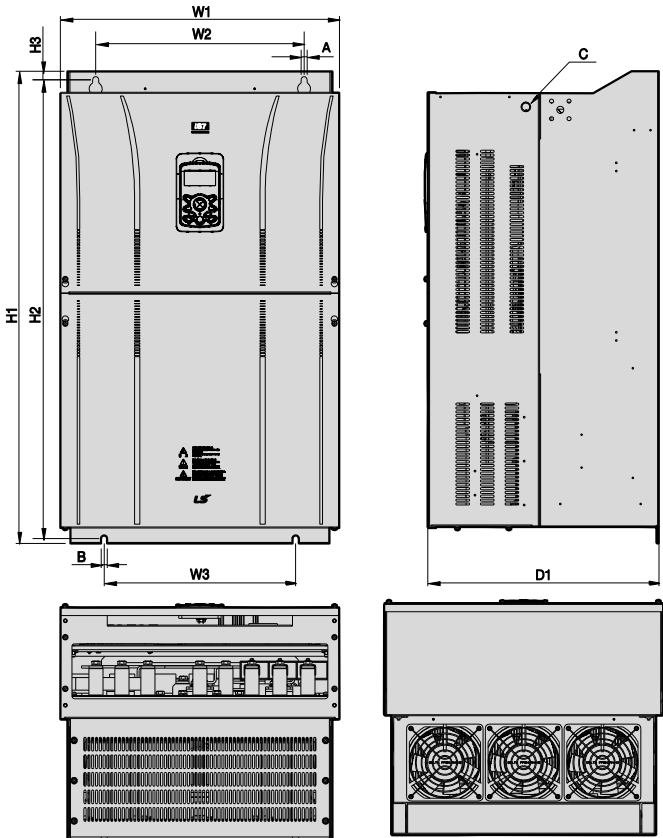

Units: mm (inch)

Inverter Capacity	W1	W2	W3	H1	H2	H3	D1	A	B	C
SV1320-1600 iS7-4	510 (20.07)	381 (15.0)	350 (13.77)	861 (33.89)	836.5 (32.93)	15.5 (0.61)	422.6 (16.63)	11 (0.43)	11 (0.43)	M16

SV1850-2200iS7 (400 V, IP00 Type)

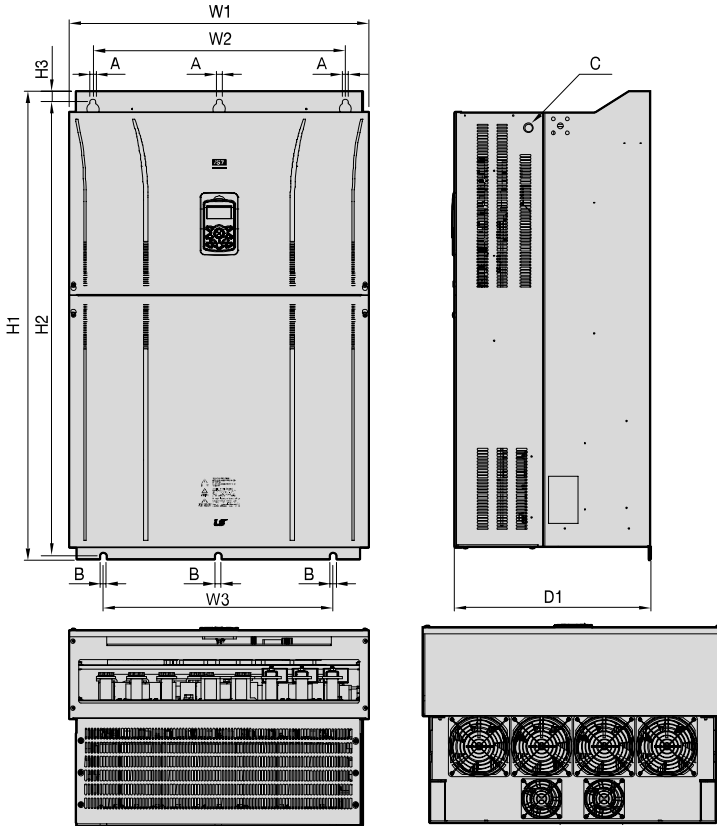

Units: mm (inch)

Inverter Capacity	W1	W2	W3	H1	H2	H3	D1	A	B	C
SV1850/ 2200iS7-4	690 (27.16)	581 (22.87)	528 (20.79)	1078 (42.44)	1043.5 (41.08)	25.5 (1.00)	450 (17.72)	14 (0.55)	15 (0.59)	M20

SV2800iS7 (400 V, IP00 Type)

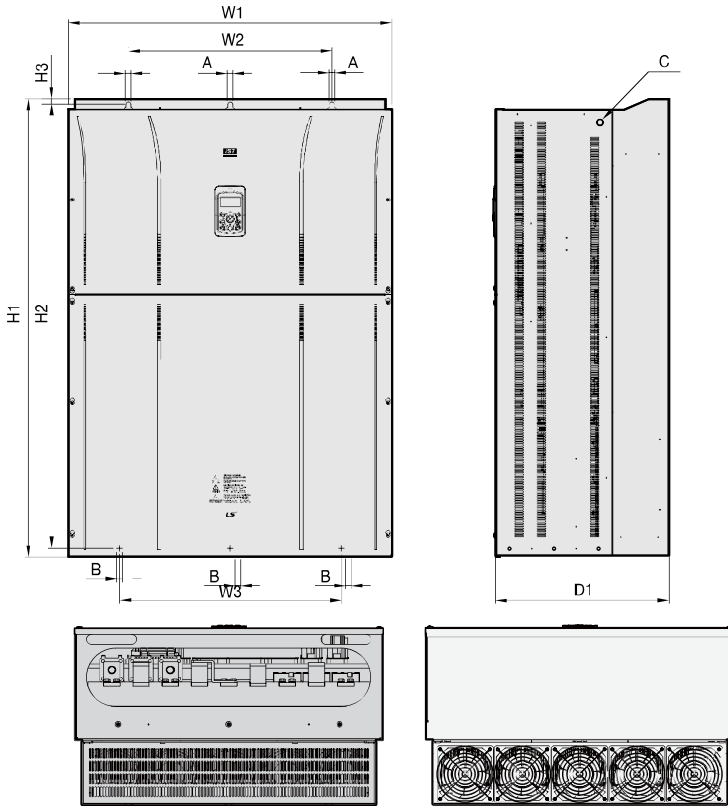

Units: mm (inch)

Inverter Capacity	W1	W2	W3	H1	H2	H3	D1	A	B	C
SV2800iS7-4	771 (30.35)	500 (19.69)	500 (19.69)	1138 (44.80)	1110 (43.70)	15 (0.59)	440 (17.32)	13 (0.51)	13 (0.51)	M16

For 280 kW model types, I volts are supplied with the product.

SV3150-3750iS7 (400 V, IP00 Type)

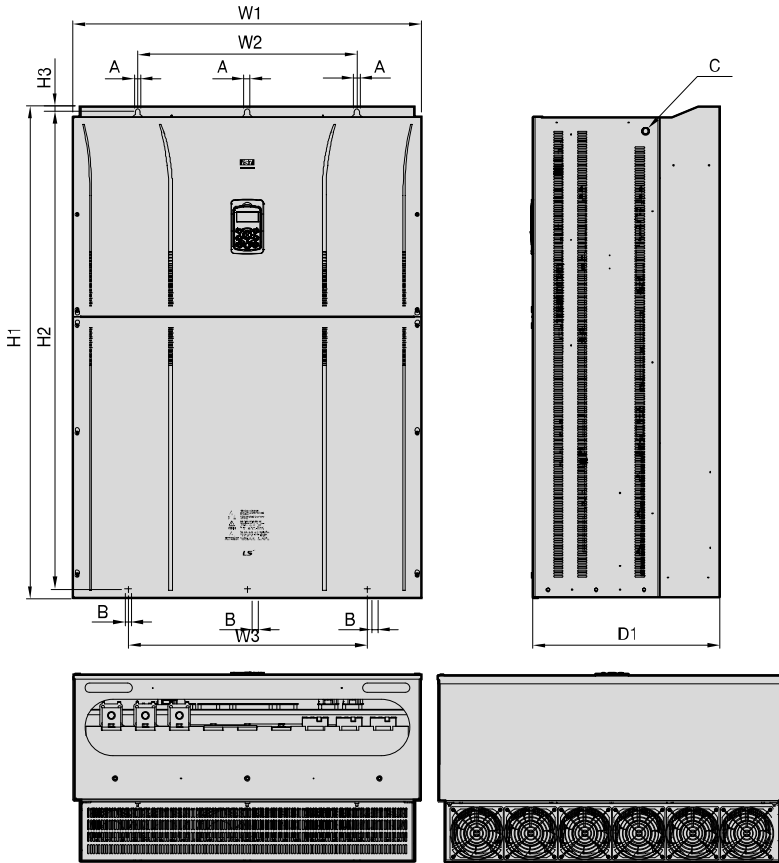

Installing
the Inverter

Units: mm (inch)

Inverter Capacity	W1	W2	W3	H1	H2	H3	D1	A	B	C
SV3150/ 3750iS7-4	922 (36.30)	580 (22.83)	580 (22.83)	1302.5 (51.28)	1271.5 (50.06)	15 (0.59)	495 (19.49)	14 (0.55)	14 (0.55)	M16

For 315-375 kW model types, I volts are supplied with the product.

3.4 Exterior and Dimensions (UL Enclosed Type 12, IP54 Type)

SV0008-0037iS7 (200 V/400 V)

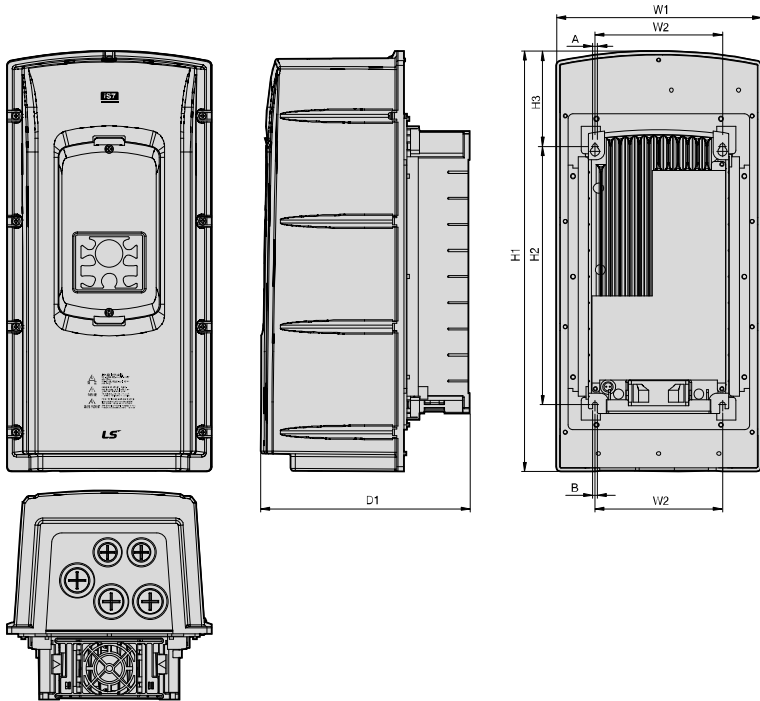

Units: mm (inch)

Inverter Capacity	W1	W2	H1	H2	H3	D1	A	B
SV0008-0037 iS7-2/4	204.2 (8.03)	127 (5.0)	419 (16.49)	257 (10.11)	95.1 (3.74)	208 (8.18)	5 (0.19)	5 (0.19)

SV0055-0075iS7 (200 V/400 V)

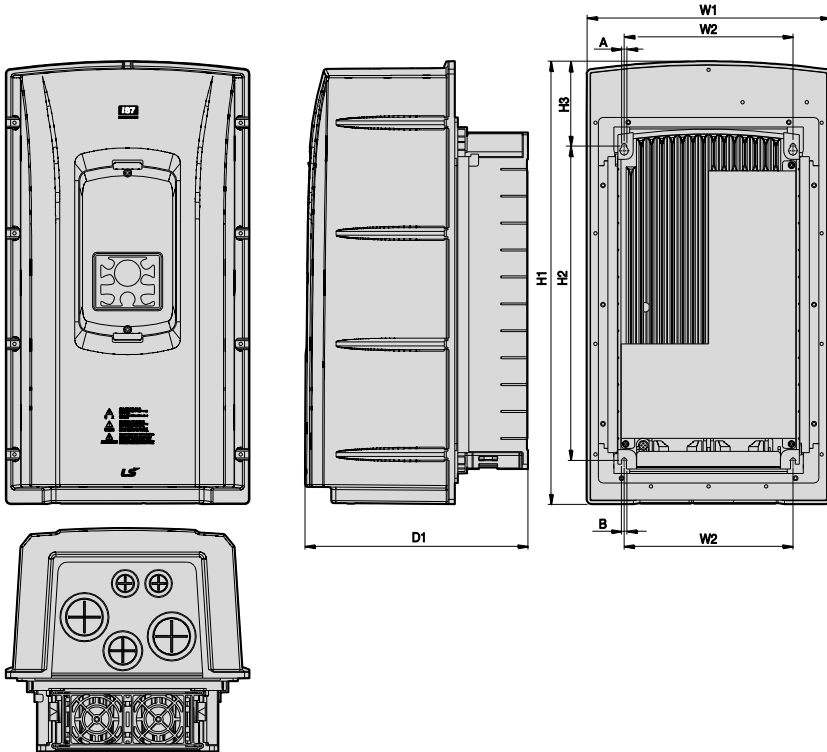

Installing
the Inverter

Units: mm (inch)

Inverter Capacity	W1	W2	H1	H2	H3	D1	A	B
SV0055-0075 iS7-2/4	254 (10.0)	176 (6.92)	460.6 (18.13)	327 (12.87)	88.1 (3.46)	232.3 (9.14)	5 (0.19)	5 (0.19)

Installing the Inverter

SV0110-0150iS7 (200 V/400 V)

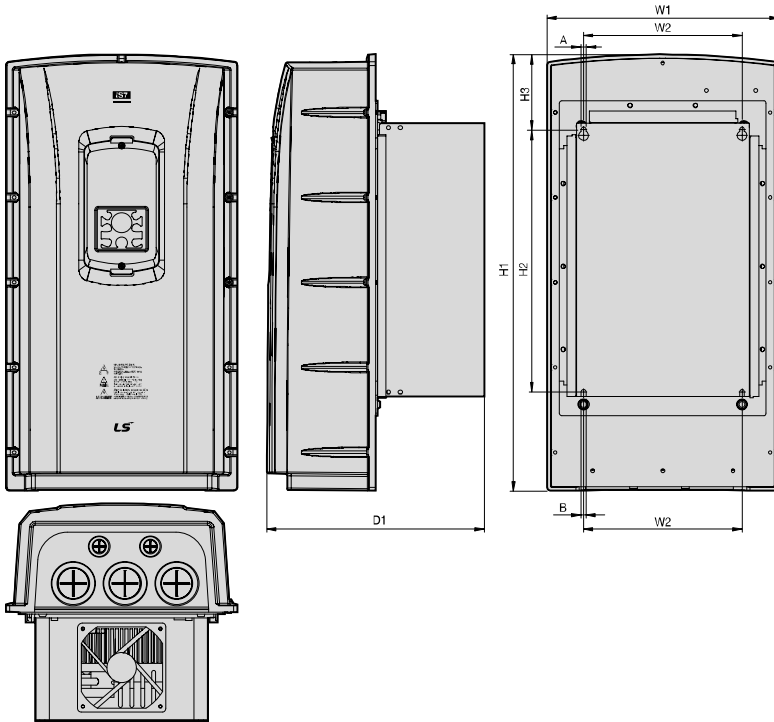

Units: mm (inch)

Inverter Capacity	W1	W2	H1	H2	H3	D1	A	B
SV0110-0150 iS7-2/4	313.1 (12.32)	214.6 (8.44)	590.8 (23.25)	355 (13.97)	101.7 (4.0)	294.4 (11.59)	6.5 (0.25)	6.5 (0.25)

SV0185-0220iS7 (200 V/400 V)

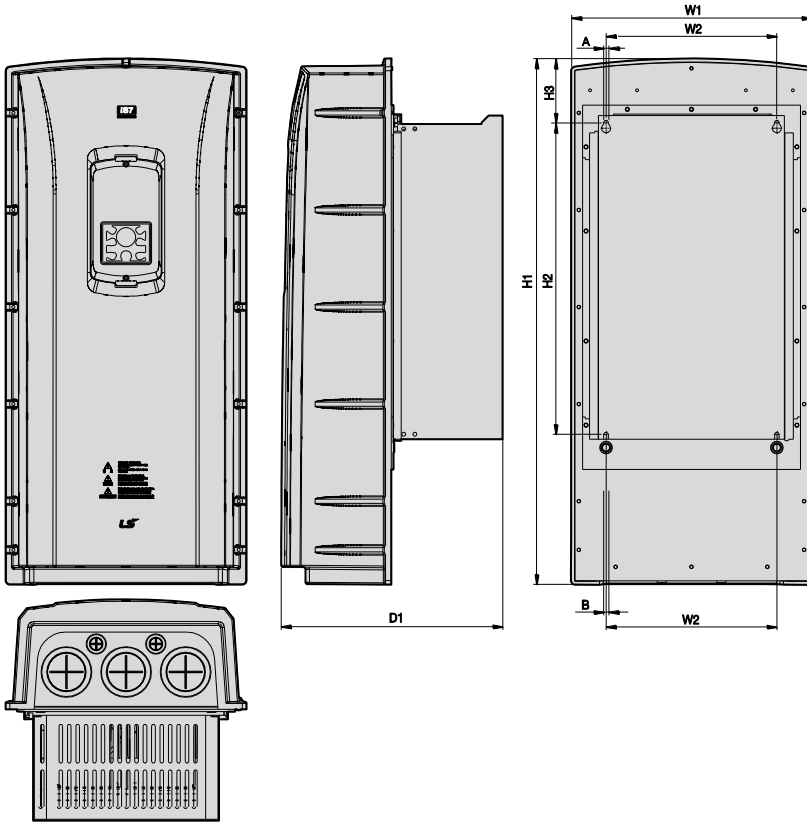

Units: mm (inch)

Inverter Capacity	W1	W2	H1	H2	H3	D1	A	B
SV0185-0220 iS7-2/4	343.2 (13.51)	243.5 (9.58)	750.8 (29.55)	445 (17.51)	91.6 (3.60)	315.5 (12.42)	6.5 (0.25)	6.5 (0.25)

Installing
the Inverter

3.5 Frame Dimensions and Weight (UL Enclosed Type 1, IP 21 Type)

Inverter Capacity	W[mm]	H[mm]	D[mm]	Weight[Kg] w/ built-in EMC and DCR	Weight[Kg] w/ built-in EMC	Weight[Kg] w/ built-in DCR	Weight[Kg] non-DCR types
SV0008iS7-2/4	150	284	200	5.5	4.5	5.0	4.5
SV0015iS7-2/4	150	284	200	5.5	4.5	5.0	4.5
SV0022iS7-2/4	150	284	200	5.5	4.5	5.0	4.5
SV0037iS7-2/4	150	284	200	5.5	4.5	5.0	4.5
SV0055iS7-2/4	200	355	225	10	8.4	9.3	7.7
SV0075iS7-2/4	200	355	225	10	8.4	9.3	7.7
SV0110iS7-2/4	250	385	284	20	17.2	16.8	14
SV0150iS7-2/4	250	385	284	20	17.2	16.8	14
SV0185iS7-2	280	461.6	298	30	27	25.9	22.9
SV0220iS7-2	280	461.6	298	30	25.8	25.9	22.9
SV0185iS7-4	280	461.6	298	27.4	23.5	23.3	19.7
SV0220iS7-4	280	461.6	298	27.4	23.5	23.5	20.1
SV0300iS7-2	300	570	265.2	-	-	-	29.5
SV0370iS7-2	370	630	281.2	-	-	-	44
SV0450iS7-2	370	630	281.2	-	-	-	44
SV0550iS7-2	465	750	355.6	-	-	-	72.5
SV0750iS7-2	465	750	355.6	-	-	-	72.5

Note

- The weight specified in the table indicates the total weight of the product without packaging, which includes the built-in parts, such as the EMC filter and DCR.
- The built-in EMC filter and DCR are not available for 30–75 kW (200 V) products.

Inverter Capacity	W[mm]	H[mm]	D[mm]	Weight[Kg] w/ built-in EMC and DCR	Weight[Kg] w/ built-in EMC	Weight[Kg] w/ built-in DCR	Weight[Kg] non-DCR types
SV0300iS7-4	300	594	300.4	-	-	41	28
SV0370iS7-4	300	594	300.4	-	-	41	28
SV0450iS7-4	300	594	300.4	-	-	41	28
SV0550iS7-4	370	663.4	371	-	-	63	45
SV0750iS7-4	370	663.4	371	-	-	63	45
SV0900iS7-4	510	784	423	-	-	101	-
SV1100iS7-4	510	784	423	-	-	101	-
SV1320iS7-4	510	861	423	-	-	114	-
SV1600iS7-4	510	861	423	-	-	114	-
SV1850iS7-4	690	1078	450	-	-	200	-
SV2200iS7-4	690	1078	450	-	-	200	-
SV2800iS7-4	771	1138	440	-	-	-	252
SV3150iS7-4	922	1302.5	495	-	-	-	352
SV3750iS7-4	922	1302.5	495	-	-	-	352

Note

- The weight specified in the table indicates the total weight of the product without packaging, which includes built-in parts, such as the EMC filter and DCR.
- 300-220 kW (400 V) products have built-in DCR only.
- 280-375 kW (400 V) products are provided without a built-in EMC filter and DCR.

3.6 Frame Dimensions and Weight (UL Enclosed Type 12, IP54 Type)

Inverter Capacity	W[mm]	H[mm]	D[mm]	Weight[Kg] w/ built-in EMC and DCR	Weight[Kg] w/ built-in EMC	Weight[Kg] w/ built-in DCR	Weight[Kg] non-DCR types
SV0008iS7-2/4	204	419	208	8.2	7.2	7.7	6.7
SV0015iS7-2/4	204	419	208	8.2	7.2	7.7	6.7
SV0022iS7-2/4	204	419	208	8.2	7.2	7.7	6.7
SV0037iS7-2/4	204	419	208	8.2	7.2	7.7	6.7
SV0055iS7-2/4	254	461	232	12.8	10.2	12.1	9.5
SV0075iS7-2/4	254	461	232	12.9	10.3	12.2	9.6
SV0110iS7-2/4	313	591	294	25.6	22.8	22.4	19.6
SV0150iS7-2/4	313	591	294	25.9	23.1	22.7	19.9
SV0185iS7-2	343	751	316	38.3	34.2	34.1	29.9
SV0220iS7-2	34	751	316	38.3	34.2	34.1	29.9
SV0185iS7-4	343	751	316	34.9	31	31	27.1
SV0220iS7-4	343	751	316	34.9	31	31	27.1

Note

- The weight specified in the table indicates the total weight of the product without packaging, which includes the built-in parts, such as the EMC filter and DCR.
- Only 0.75-22 kW products are available in IP 54 Type specifications.

3.7 Installation Procedures for UL Enclosed Type12 and IP54 Type Products

3.7.1 Disassembling the Keypad Cover and Keypad

- 1 Loosen the screws that secure the keypad cover and remove the keypad cover.

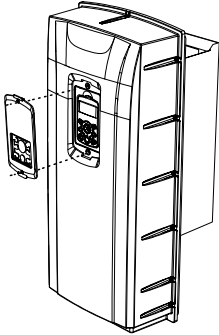

- 2 Depress the tab at the top of the keypad and gently lift the keypad from the inverter to remove it. Be careful not to damage the keypad cable.

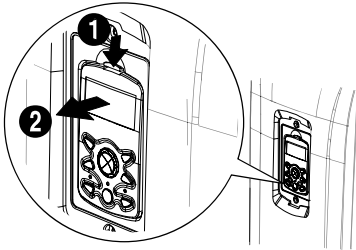

- 3 Depress the tab on the keypad cable connector and disconnect the cable from the back of the keypad.

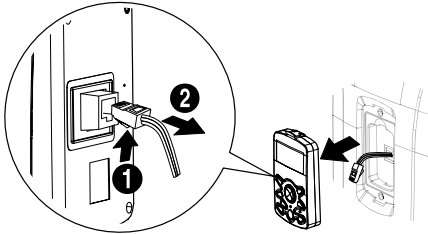

3.7.2 Disassembling the IP54 Front Cover

- 1 Loosen the screws that secure the front cover to the chassis. There are 9-13 screws on the cover depending on the model type.

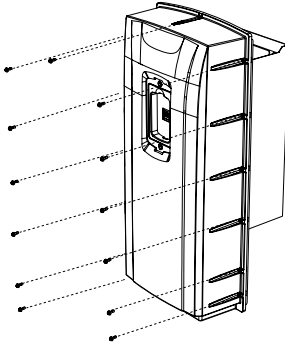

- 2 Remove the cover by lifting it upwards from the bottom.

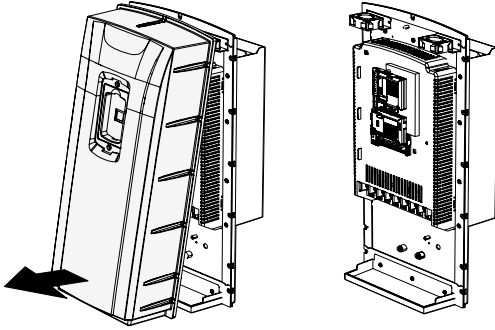

3.7.3 Mounting the Inverter

- 1 Remove the 4 rubber feet from the corners.

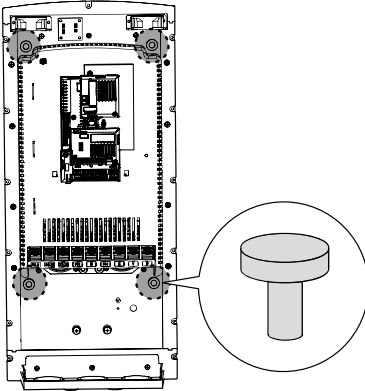

- 2 Place the inverter on a flat wall or in a cabinet, and use 4 screws or bolts to securely fix the inverter to the surface.

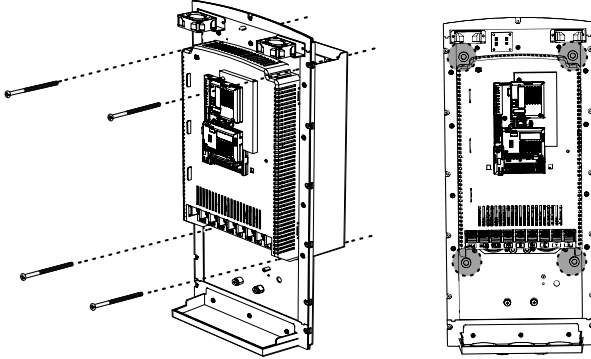

3.7.4 Connecting the Power Cables

Connect the power cables to the input (R, S, T) and output (U, V, W) terminals. Then, tighten the terminal screws.

Refer to [4 Connecting the Cables](#) on page [49](#) for detailed information.

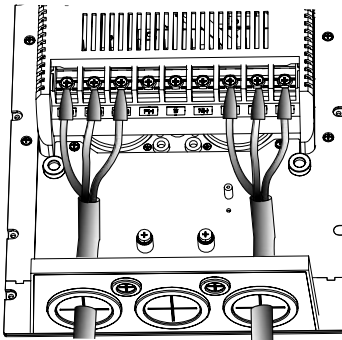

3.7.5 Reassembling the IP54 Front Cover and the Keypad

- 1 Place the front cover on the chassis and align the screw holes on each side.

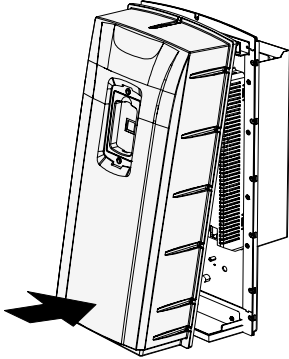

- 2 Insert and tighten the screws. There are 9-13 screws on the cover depending on the model type.

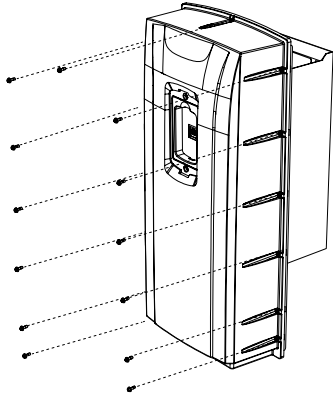

Installing the Inverter

- 3 Connect the signal cable to the keypad, align the lower part of the keypad to the bottom of the keypad receptacle, and then push the top part of the keypad into the chassis until the keypad snaps into place.

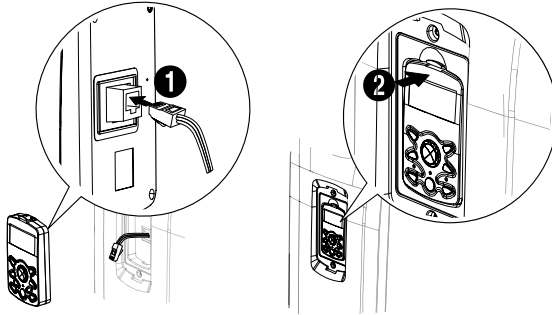

- 4 Place the keypad cover on top of the keypad, and secure it using 2 screws.

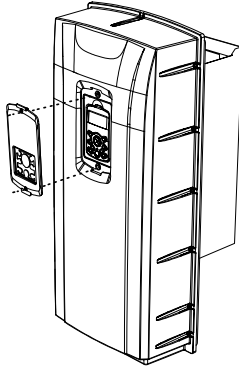

4 Connecting the Cables

Connect cables to the power and signal terminal blocks of the inverter.

ⓘ Caution

ESD (Electrostatic discharge) from the human body may damage sensitive electronic components on the PCB. Therefore, be extremely careful not to touch the PCB or the components on the PCB with bare hands while you work on the I/O PCB.

To prevent damage to the PCB from ESD, touch a metal object with your hands to discharge any electricity before working on the PCB, or wear an anti-static wrist strap and ground it on a metal object.

4.1 Removing the Front Cover for Cable Connection

⚠ Danger

Wait at least 10 minutes before opening the covers and exposing the terminal connections. Before working on the inverter, test the connections to ensure the DC voltage has been fully discharged. Personal injury or death by electric shock may result if the DC voltage has not been discharged.

4.1.1 IP 21 Type Products

- 1 Depress the tab at the top of the keypad and gently lift the keypad from the inverter to remove it. Be careful not to damage the keypad cable.

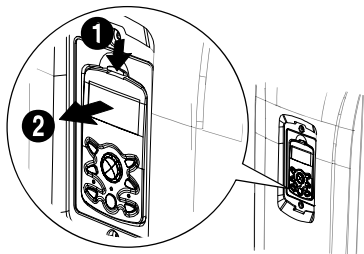

Connecting the Cables

- 2 Depress the tab on the keypad cable connector and disconnect the cable from the back of the keypad.

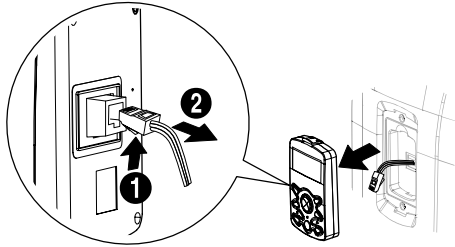

- 3 Loosen the screw from the bottom part of the front cover, and then remove the front cover.

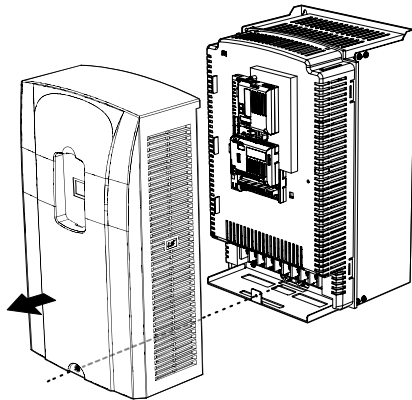

4.1.2 IP 54 Type Products

- 1 Loosen the two screws securing the keypad cover, and then remove the keypad cover.

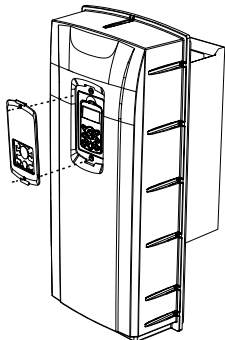

- 2 Depress the tab at the top of the keypad and gently lift the keypad from the inverter to remove it. Be careful not to damage the keypad cable.

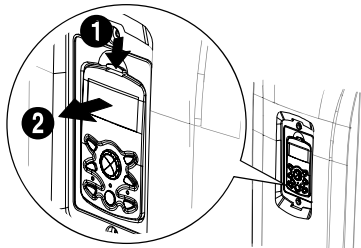

- 3 Depress the tab on the keypad cable connector and disconnect the cable from the back of the keypad.

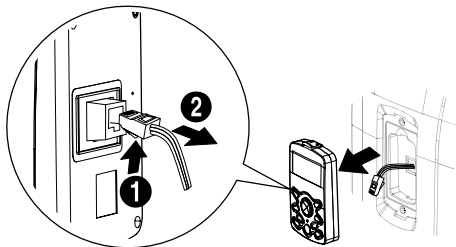

- 4 Remove the screws from each side of the front cover, and then remove the front cover.

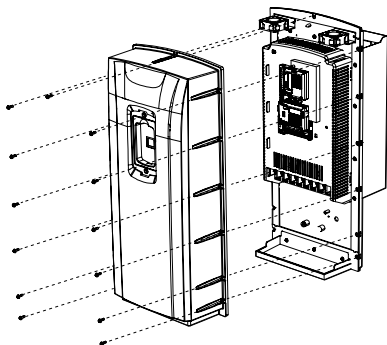

4.13 90–375 kW, 400 V and 30–75 kW, 200 V Products

- 1 Loosen the two screws on the front cover.

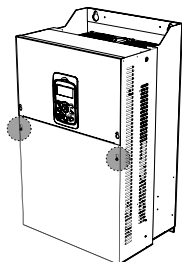

- 2 Slide the cover downwards and remove it from the inverter.

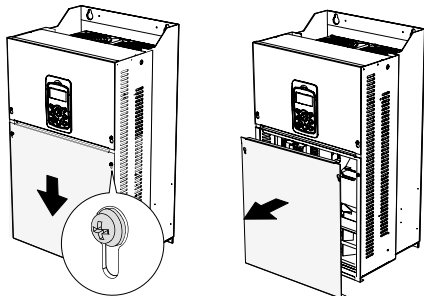

4.2 Activating and Deactivating the Built-in EMC Filter

Some iS-7 inverter models have built-in EMC filters to reduce conductive and radiational noise at the inverter input. Refer to *1.1.1 Identifying the Product* on page 1 and check your inverter's model type and specifications to see if it has a built-in EMC filter.

If your inverter has a built-in EMC filter, refer to the following instructions to activate or deactivate it.

⚠ Danger

Do not activate the EMC filter if the inverter uses a power source with an asymmetrical grounding structure, for example a grounded delta connection. Personal injury or death by electric shock may result if the power source is not grounded properly.

4.2.1 Up to 7.5 kW Inverters

- 1 Locate the plastic knockout cap that covers the EMC filter switch (jumper SW1).

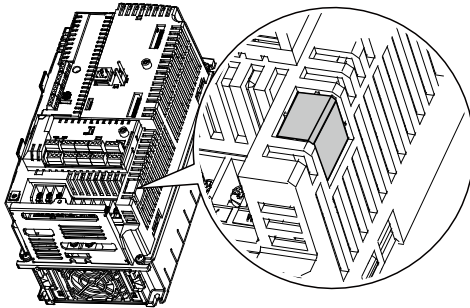

- 2 Remove the knockout cap and locate the jumper switch. The EMC filter will be deactivated if the two jumper pins are not connected.

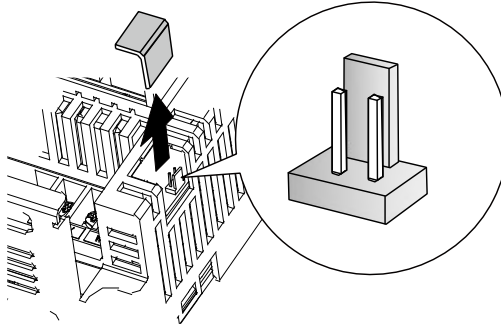

- 3 Connect the two jumper pins using a short circuit connector to activate the EMC filter.

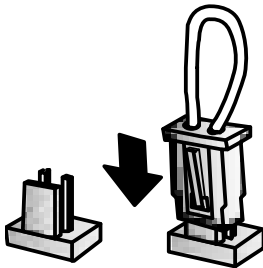

- 4 To remove the short circuit connector and deactivate the EMC filter, pull the connector while pressing the latch on the side of the connector. Use pliers or tweezers if you cannot reach the latch with your fingers.

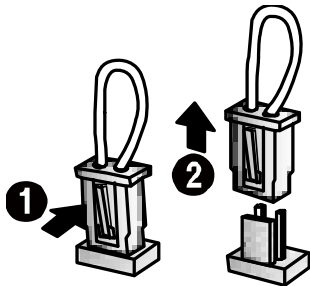

4.2.2 11–22 kW Inverters

- 1 Locate the EMC filter cable and the ground terminal at the bottom of the inverter.

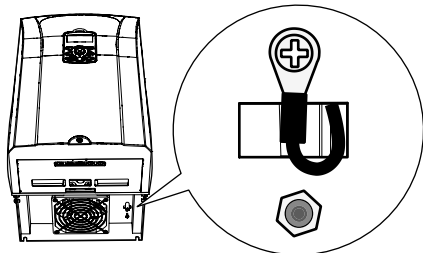

The EMC filter is deactivated if the EMC filter cable is connected to the insulated stud.



<EMC filter is turned OFF>

- 2 Remove the EMC filter cable from the insulated stud and connect it to the ground terminal (metal) to activate the EMC filter.

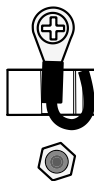

<EMC filter is turned ON>

An EMC filter prevents electromagnetic interference by reducing radio emissions from the inverter. Using an EMC filter is not always recommended, as it increases current leakage. If an inverter uses a power source with an asymmetrical grounding connection, the EMC filter must be turned off.

Before using the inverter, confirm the power supply's grounding system. Disable the EMC filter if the power source has an asymmetrical grounding connection.

Connecting the Cables

Asymmetrical Grounding Connection

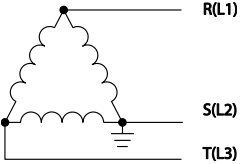
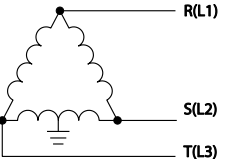
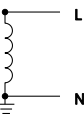
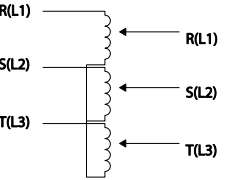
<p>One phase of a delta connection is grounded</p>	 <p>A delta connection with three phases labeled R(L1), S(L2), and T(L3). The S(L2) phase is connected to a ground symbol.</p>	<p>Intermediate grounding point on one phase of a delta connection</p>	 <p>A delta connection with three phases labeled R(L1), S(L2), and T(L3). An intermediate grounding point is shown on the S(L2) phase, connected to a ground symbol.</p>
<p>The end of a single phase is grounded</p>	 <p>A single phase winding with terminals L and N. Terminal N is connected to a ground symbol.</p>	<p>A 3-phase connection without grounding</p>	 <p>A 3-phase connection with three windings labeled R(L1), S(L2), and T(L3). Each winding has an arrow pointing to its terminal, but none are grounded.</p>

Note

- When the EMC Filter is deactivated, the Y-CAP is disconnected from Ground

4.3 Precautions for Wiring the Inverter

Warning

- Do not connect power to the inverter until installation has been fully completed and the inverter is ready to be operated. Doing so may result in electric shock.
- Wiring and inspection of wiring must be performed by an authorized engineer.

Caution

- Install the inverter before connecting the cables.
- Ensure that no metal debris, such as wire clippings, remain inside the inverter. Metal debris in the inverter can cause inverter failure.
- Power supply cables must be connected to the R, S, and T terminals. Connecting power cables to other terminals will damage the inverter.
- Use insulated ring lugs when connecting cables to R/S/T and U/V/W terminals.
- The inverter's power terminal connections can cause harmonics that may interfere with other communication devices located near the inverter. To reduce interference, the installation of noise filters or line filters may be required.
- To avoid circuit interruption or damaging connected equipment, do not install phase-advanced condensers, surge protection, or electronic noise filters on the output side of the inverter.
- To avoid circuit interruption or damaging connected equipment, do not install magnetic contactors on the output side of the inverter.
- Make sure that the total cable length does not exceed 495 ft (150 m). For inverters ≤ 3.7 kW capacity, ensure that the total cable length does not exceed 165 ft (50 m). Long cable runs can cause reduced motor torque in low frequency applications due to voltage drop. Long cable runs also increase a circuit's susceptibility to stray capacitance and may trigger over-current protection devices or result in the malfunction of equipment connected to the inverter.
- Route the signal cables away from the power cables. Otherwise, signal errors may occur due to electric interference.
- Tighten terminal screws to their specified torques. Loose terminal block screws may allow the cables to disconnect and cause a short circuit or inverter failure. Refer to [4.7 Specifications of the Power Terminal Block and Exterior Fuse](#) on page 6666 for torque specifications.
- Do not place heavy objects on top of electric cables. Heavy objects may damage the cable and result in electric shock.
- Use cables with the largest cross-sectional area, appropriate for power terminal wiring, to ensure that voltage drops do not exceed 2%.
- Use copper cables rated at 600 V, 75 °C for power terminal wiring.
- Use copper cables rated at 300 V, 75 °C for control terminal wiring.
- If you need to rewire the terminals due to wiring-related faults, ensure that the inverter keypad display is turned off and the charge lamp under the terminal cover is off before working on wiring connections. The inverter may hold a high-voltage electric charge long after the power supply has been turned off.

4.4 Ground Connection

Warning

Install ground connections for the inverter and the motor by following the correct specifications to ensure safe and accurate operation. Using the inverter and the motor without the specified grounding connections may result in electric shock.

Caution

- Do not use the ground terminal as the signal (control) ground.
- Do not share the ground connection with other machines that consume a large amount of power, such as a welding machine.
- Connect the ground cable to the nearest earth contact and keep the cable length as short as possible.

Because the inverter is a high-frequency switching device, leakage current may occur during operation. To avoid the danger of electrocution due to current leakage, the inverter must be properly grounded. Ground connection must be made to the specified ground terminal on the inverter. Do not connect ground cables to chassis screws.

Note

- 200 V products require Class 3 grounding. Resistance to ground must be $\leq 100 \Omega$.
- 400 V products require Special Class 3 grounding. Resistance to ground must be $\leq 10 \Omega$.

The following table lists the minimum ground cable specifications that must be met to properly ground the inverters.

Inverter Capacity	Grounding wire size (mm ²)	
	200 V class	400 V class
0.75–3.7kW	4	2.5
5.5–7.5 kW	6	4
11–15 kW	16	10
18.5–22 kW	25	16
30–45 kW	25	16
55–75 kW	35	35
90–110 kW	-	60
132–220 kW	-	100
280–315 kW	-	185
375 kW	-	240

4.5 Terminal Wiring Diagram

4.5.1 Up to 7.5 kW Inverters

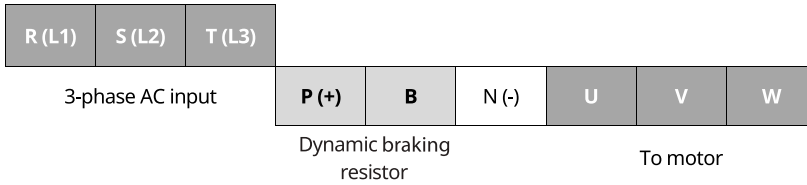

4.5.2 11–22 kW Inverters

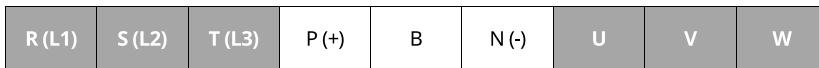

4.5.3 30–75 kW Inverters

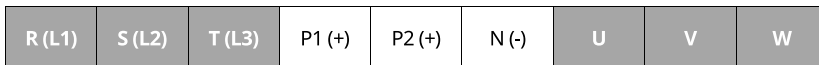

4.5.4 90–160 kW Inverters

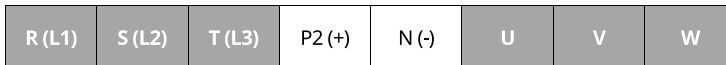

4.5.5 185–220 kW Inverters

R (L1)	S (L2)	T (L3)	P2 (+)	N (-)	U	V	W
--------	--------	--------	--------	-------	---	---	---

4.5.6 280–375 kW Inverters

R (L1)	S (L2)	T (L3)	P1 (+)	P2 (+)	N (-)	U	V	W
--------	--------	--------	--------	--------	-------	---	---	---

Note

- Inverters with a rated capacity of 11 kW or more are equipped with linearly arranged terminal blocks.
- 0.75–22 kW inverters have built-in DC reactors. The installation of an external DC reactor is not necessary for these inverters.
- The inverter must be properly grounded using the ground terminal.

Note

If the forward command (Fx) is turned on, the motor should rotate counterclockwise when viewed from the load side of the motor. If the motor rotates in the reverse direction, switch the cables at the U and V terminals.

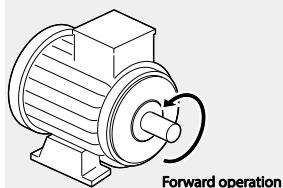

Remarque

Si la commande avant (Fx) est activée, le moteur doit tourner dans le sens anti-horaire si on le regarde côté charge du moteur. Si le moteur tourne dans le sens inverse, inverser les câbles aux bornes U et V.

4.6 Connecting Cables to the Power Terminal Block

⚠ Caution

Power supply cables must be connected to the R, S, and T terminals. Connecting power cables to other terminals will damage the inverter.

Note

The motor will rotate in the opposite direction if the U, V, and W terminals are connected in a wrong phase order.

4.6.1 0.75–22 kW (200 V/400 V)

Cable connection for utilizing the built-in dynamic braking unit

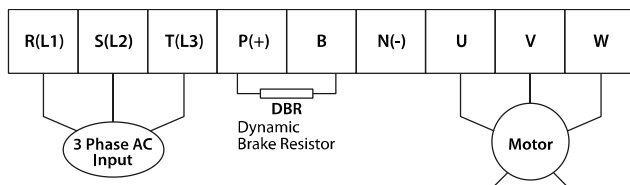

Connect the cables from the dynamic braking unit to the P (+) and B terminals to utilize the built-in dynamic braking unit.

Terminal Symbol	Terminal Name	Description
R (L1), S (L2), T (L3)	AC power supply input terminals	AC input terminals
P (+)	(+) DC voltage terminal	(+) DC link voltage terminal
N (-)	(-) DC voltage terminal	(-) DC link voltage terminal.
P (+), B	Dynamic braking resistor terminals	Dynamic braking resistor terminals
U, V, W	Inverter output terminals	Output terminals to a 3-phase induction motor

Cable connection for utilizing the optional dynamic braking unit

Connect the cables from dynamic braking unit to P (+) and N (-) terminals to utilize the optional dynamic braking unit. Do not connect cables to B terminal.

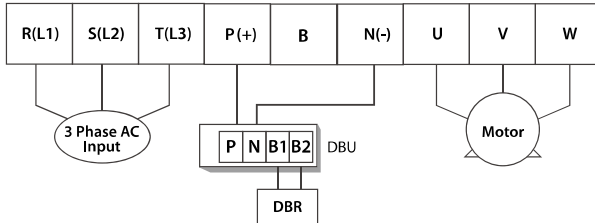

Terminal Symbol	Terminal Name	Description
R (L1), S (L2), T (L3)	AC power supply input terminals	AC input terminals
P (+)	(+) DC voltage terminal	(+) DC link voltage terminal
N (-)	(-) DC voltage terminal	(-) DC link voltage terminal.
P (+), B	Dynamic braking resistor terminals	Dynamic braking resistor terminals
U, V, W	Inverter output terminals	Output terminals to a 3-phase induction motor

4.6.2 30–75 kW (200 V/400 V)

Connect the cables from the dynamic braking unit to the P (+) and B terminals to utilize the built-in dynamic braking unit.

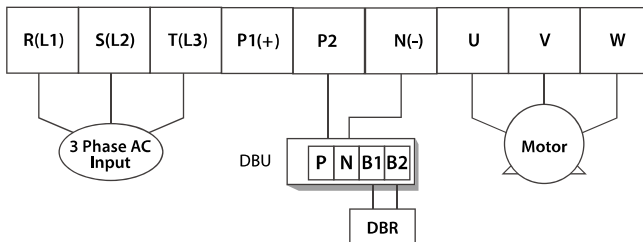

In 30-75 kW 200 V model types, the P1 and P2 terminals are connected with a jumper pin.

Terminal Symbol	Terminal Name	Description
R (L1), S (L2), T (L3)	AC power supply input terminals	AC input terminals
P1 (+)	(+) DC voltage terminal	(+) DC link voltage terminal
P2, N (-)	Dynamic braking resistor terminal / DC common*	Dynamic braking resistor terminals
N (-)	(-) DC voltage terminal	(-) DC link voltage terminal
U, V, W	Inverter output terminals	Output terminals to a 3-phase induction motor

*Contact LS ELECTRIC Customer Support before configuring the P2 (+) and N (-) terminals as the DC common source. There are a few factors that require special attention for this application.

Note

External DC reactors cannot be used with 30–75 kW inverters. To use a DC reactor with these inverters, purchase a 30–75 kW inverter that has a built-in DC reactor.

⚠ Caution

- When a built-in DCR unit is present, the P1 (+) and P (-) terminals are connected to the reactor's input and output terminals respectively.
- If your product does not have a built-in DCR unit, the P2 (+) and N (-) terminals may be used as the common DC source. Do not use the P1 (+) terminal as the common DC source, as this may result in product damage.
- Use the P2 (+) and N (-) terminals to connect a dynamic braking resistor to the inverter. Do not connect the dynamic braking unit to the P1 (+) terminal, as this may result in product damage.
- Contact LS ELECTRIC Customer Support before configuring the N (-) terminal as the DC common source. There are a few factors that require special attention for this application.

4.6.3 90–160 kW (400 V)

Connect the cables from the dynamic braking unit to the P2 (+) and N (-) terminals to utilize an external dynamic braking unit.

Connecting the Cables

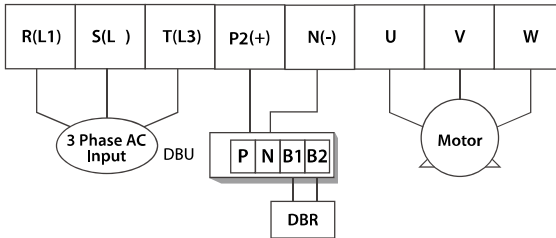

Terminal Symbol	Terminal Name	Description
R (L1), S (L2), T (L3)	AC power supply input terminals	AC input terminals
N (-)	(-) DC voltage terminal	(-) DC link voltage terminal
P2 (+), N (-)	Dynamic braking resistor terminal	Dynamic braking resistor terminal
U, V, W	Inverter output terminals	Output terminals to a 3-phase induction motor

4.6.4 185–220 kW (400 V)

Connect the cables from the dynamic braking unit to the P2 (+) and N (-) terminals to utilize an external dynamic braking unit.

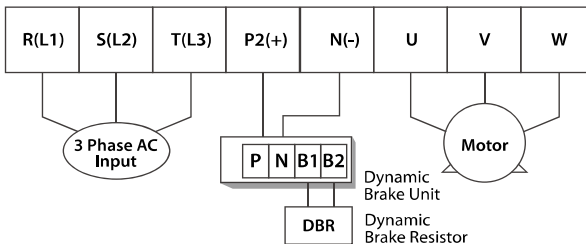

Terminal Symbol	Terminal Name	Description
R (L1), S (L2), T (L3)	AC power supply input terminals	AC input terminals
N (-)	(-) DC voltage terminal	(-) DC link voltage terminal
P2 (+), N (-)	Dynamic braking resistor terminal	Dynamic braking resistor terminal
U, V, W	Inverter output terminals	Output terminals to a 3-phase induction motor

4.6.5 280–375 kW (200 V/400 V)

Connect the cables from the dynamic braking unit to the P2 (+) and N (-) terminals to utilize the built-in dynamic braking unit.

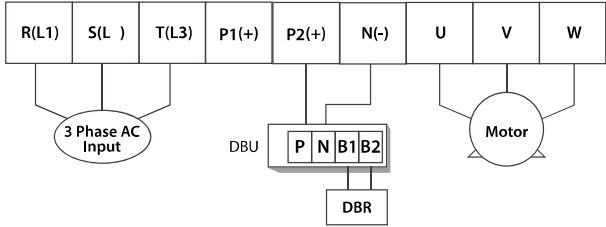

Terminal Symbol	Terminal Name	Description
R (L1), S (L2), T (L3)	AC power supply input terminals	AC input terminals
P1 (+)	(+) DC voltage terminal	(+) DC link voltage terminal
P2/N (-)	Dynamic braking resistor terminal / DC common*	Dynamic braking resistor terminals
N (-)	(-) DC voltage terminal	(-) DC link voltage terminal
U, V, W	Inverter output terminals	Output terminals to a 3-phase induction motor

*Contact LS ELECTRIC Customer Support before configuring the P2 (+) and N (-) terminals as the DC common source. There are a few factors that require special attention for this application.

ⓘ Caution

- Apply rated torques to the terminal screws. Loose screws may cause the terminals to short circuit and malfunction. Tightening the screws too much may damage the terminals and cause them to short circuit and malfunction.
- Only use copper wires with a 600 V, 75 °C rating for the power terminal wiring, and a 300 V, 75 °C rating for the control terminal wiring.
- Power supply wiring must be connected to the R, S, and T terminals. Connecting them to the U, V, W terminals causes internal damage to the inverter. The motor should be connected to the U, V, and W terminals. Arrangement of the phase sequence is not necessary.

4.7 Specifications of the Power Terminal Block and Exterior Fuse

Inverter capacity	Terminal screw size	Screw torque ¹⁾ (Kgf·cm)	Cable ²⁾				Exterior fuse		
			mm ²		AWG or kcmil		Current	Voltage	
			R,S,T	U,V,W	R,S,T	U,V,W			
200V	0.75 kW	M4	7.1-12	2.5	2.5	14	14	10 A	500 V
	1.5 kW	M4	7.1-12	2.5	2.5	14	14	15 A	500 V
	2.2 kW	M4	7.1-12	2.5	2.5	14	14	20 A	500 V
	3.7 kW	M4	7.1-12	4	4	12	12	32 A	500 V
	5.5 kW	M4	7.1-12	6	6	10	10	50 A	500 V
	7.5 kW	M4	7.1-12	10	10	8	8	63 A	500 V
	11 kW	M6	30.6-38.2	16	16	6	6	80 A	500 V
	15 kW	M6	30.6-38.2	25	25	4	4	100 A	500 V
	18.5 kW	M8	61.2-91.8	35	35	2	2	125 A	500 V
	22 kW	M8	61.2-91.8	50	50	1	1	160 A	500 V
	30 kW	M8	61.2-91.8	70	70	1/0	1/0	200 A	500 V
	37 kW	M8	61.2-91.8	95	95	2/0	2/0	250 A	500 V
	45 kW	M8	61.2-91.8	95	95	2/0	2/0	350 A	500 V
55 kW	M10	89.7 - 122.0	120	120	3/0	3/0	400 A	500 V	
75 kW	M10	89.7 - 122.0	150	150	4/0	4/0	450 A	500 V	
400V	0.75-1.5kW	M4	7.1-12	2.5	2.5	14	14	10 A	500 V
	2.2 kW	M4	7.1-12	2.5	2.5	14	14	15 A	500 V
	3.7 kW	M4	7.1-12	2.5	2.5	14	14	20 A	500 V
	5.5 kW	M4	7.1-12	4	2.5	12	14	32 A	500 V
	7.5 kW	M4	7.1-12	4	4	12	12	35 A	500 V
	11 kW	M5	24.5-31.8	6	6	10	10	50 A	500 V
	15 kW	M5	24.5-31.8	10	10	8	8	63 A	500 V
	18.5 kW	M6	30.6-38.2	16	10	6	8	70 A	500 V
	22 kW	M6	30.6-38.2	25	16	4	6	100 A	500 V
	30 kW	M8	61.2-91.8	25	25	4	4	125 A	500 V
	37 kW	M8	61.2-91.8	25	35	4	2	125 A	500 V
	45 kW	M8	61.2-91.8	50	50	1	1	160 A	500 V
	55 kW	M8	61.2-91.8	70	70	1/0	1/0	200 A	500 V
	75 kW	M8	61.2-91.8	95	95	2/0	2/0	250 A	500 V
	90 kW	M12	182.4-215.0	100	100	4/0	4/0	350 A	500 V
110 kW	M12	182.4-215.0	100	100	4/0	4/0	400 A	500 V	
132 kW	M12	182.4-215.0	150	150	300	300	450 A	500 V	
160 kW	M12	182.4-215.0	200	200	400	400	450 A	500 V	
185 kW	M12	182.4-215.0	200	200	400	400	620 A	500 V	

Inverter capacity	Terminal screw size	Screw torque ¹⁾ (Kgf·cm)	Cable ²⁾				Exterior fuse	
			mm ²		AWG or kcmil		Current	Voltage
			R,S,T	U,V,W	R,S,T	U,V,W		
220 kW	M12	182.4-215.0	250	250	500	500	800 A	500 V
280 kW	M12	182.4-215.0	325	325	650	650	1000 A	500 V
315 kW	M12	182.4-215.0	2x200	2x200	2x400	2x400	1200 A	500 V
375 kW	M12	182.4-215.0	2x250	2x250	2x500	2x500	1400 A	500 V

1) Apply rated torques to the terminal screws. Loose screws may cause the terminals to short circuit and malfunction.

2) Only use copper wires with a 600 V, 75°C rating for the power terminal wiring.

4.7.1 Cable Length between the Inverter and the Motor

The maximum cable lengths of the inverter and the motor are listed in <Table 1) Maximum cable length by inverter capacity>.

Make sure that the total cable length does not exceed 495 ft (150 m). For inverters with a capacity of less than 3.7 kW, ensure that the total cable length does not exceed 165 ft (50 m). Long cable runs can cause reduced motor torque in low frequency applications due to voltage drop. Long cable runs also increase a circuit's susceptibility to stray capacitance and may trigger over-current protection devices, or result in the malfunction of equipment connected to the inverter.

<Table 1) Maximum Cable Length by Inverter Capacity>

Inverter capacity	Up to 3.7 kW	5.5 kW or more
Maximum cable length	< 164 ft (50 m)	< 492 ft (150 m)

The following table lists maximum carrier frequencies available for model types with a rated capacity of 5.5 kW or more.

<Table 2) Maximum Carrier Frequency according to Cable Length>

Distance	< 165 ft (50 m)	< 330 ft (100 m)	> 330 ft (100 m)
Allowed Carrier Frequency	<15 kHz	<5 kHz	<2.5 kHz

Depending on the system layout and operating conditions at the installation site, high peak output voltage may result.

a) If the output peak voltage is too high even when the motor cable length is shorter than the maximum recommended cable length for the inverter capacity:

- use a motor with a high insulation rating.
- install an output circuit filter (micro surge filter).
- install a dv/dt filter, or a sine wave filter.

b) If the cable length is too long:

- use thicker cables to prevent voltage drop.
[Voltage Drop (V) = $[\sqrt{3} \times \text{cable resistance (m}\Omega/\text{m)} \times \text{cable length (m)} \times \text{current (A)}] / 1000$]
- do not use 3-core cables.
- use a lower carrier frequency.

4.7.2 Protective Measures for the Inverter and the Motor

The inverter output voltage pulse, regardless of the actual output frequency, is identical to the DC link voltage pulse, which has a very short rising time. When the power is transmitted through the output cables, the output peak voltage can rise up to twice the total DC link voltage (2.8 times the main power voltage).

If a switching device (a magnetic contactor or relay) is connected to the output side of the inverter, high-voltage surges may result whenever a switch is made, regardless of the length of the motor cable.

Such high-voltage surges can damage the inverter's output components (such as the current sensor), motor cables, and the motor itself. To protect the inverter and the motor from such damage caused by a high-voltage surge, do not install switching devices in the output side of the inverter. You can install an output reactor, dv/dt filter, or sine wave filter to protect the inverter and motor from a surge voltage.

An output surge with a high switching frequency and fast rising time causes a motor shaft current that runs through the motor bearing. It slowly corrodes the surface of the motor bearing, eventually seizing up the motor.

To decrease the motor shaft current and protect the motor insulation, refer to <Table 1) Maximum cable length by inverter capacity>. Install a dv/dt filter or sine wave filter if possible, regardless of the length of the motor cable.

⚠ Caution

Only use Class H or RK5 UL listed input fuses and UL listed breakers. See the table above for the voltage and current ratings for the fuses and breakers.

Utiliser UNIQUEMENT des fusibles d'entrée homologués de Classe H ou RK5 UL et des disjoncteurs UL. Se reporter au tableau ci-dessus pour la tension et le courant nominal des fusibles et des disjoncteurs.

4.8 Control Terminal Wiring for iS7 Inverters Rated for Up To 22 kW

The iS7 inverter supports both PNP (Source) and NPN (Sink) modes for sequence inputs at the terminal. Select an appropriate mode to suit your requirements using the PNP/NPN selection switch above the control terminal block. Refer to the following information for detailed applications.

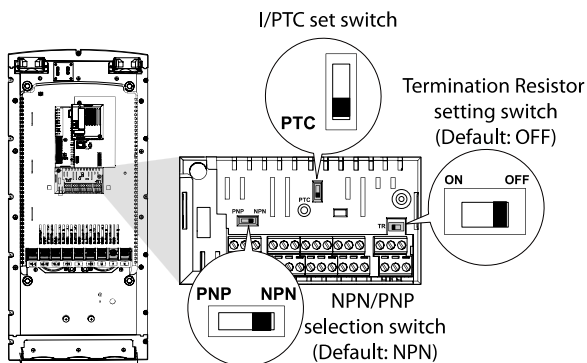

4.8.1 NPN Mode (Sink)

Select NPN using the PNP/NPN selection switch. The factory default setting is NPN mode. CM (24V GND) is the common ground terminal for all terminal inputs.

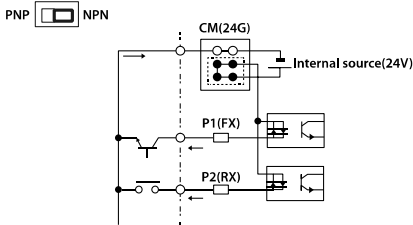

4.8.2 PNP Mode (Source)

Select PNP using the PNP/NPN selection switch. The factory default setting is NPN mode. CM (24 V GND) is the common ground terminal for all terminal inputs, and 24 is the 24 V internal source. If you are using an external 24 V source, select PNP (sink) mode and build a circuit that connects the external source (-) and the CM terminal.

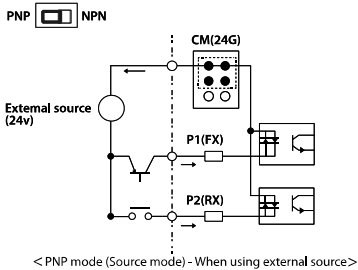
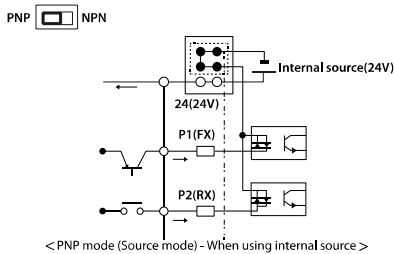

4.8.3 0.75–22 kW (Basic I/O)

Wiring Examples

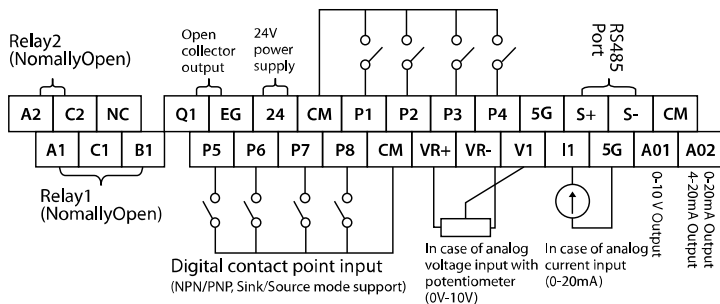

Default Functions Assigned for the Multi-Function Terminals

P1	P2	P3	P4	P5	P6	P7	P8
FX	RX	BX	RST	Sp-L	Sp-M	Sp-H	JOG

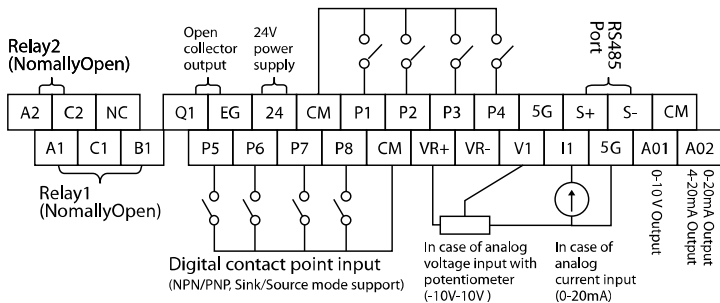

Note

- The TR (termination resistor) switch is used to terminate the RS485 network connection (120 Ω). Please turn on the TR switch of the last positioned Drive and turn off the TR switch of the remaining drives.
- For analog voltage input, use a potentiometer rated at 0.5W, 1kOhm.
- Refer to [13 Table of Functions](#) on page [385](#) for the multi-function terminal configurations.

4.9 Control Terminal Wiring for iS7 Inverters Rated for 30 kW or More

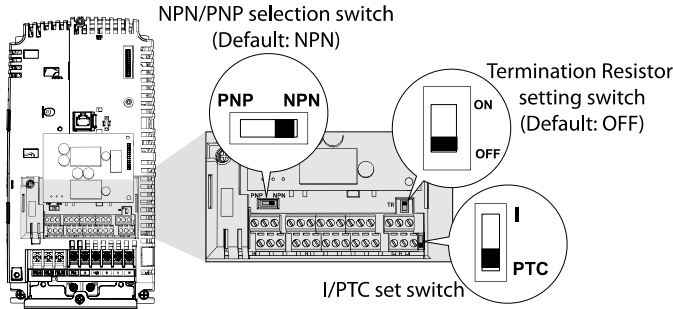

30-375 kW (control terminal block)

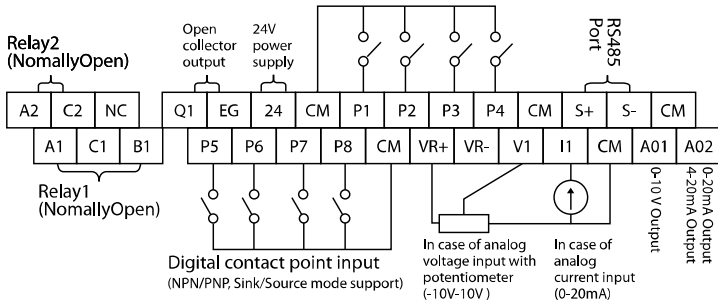
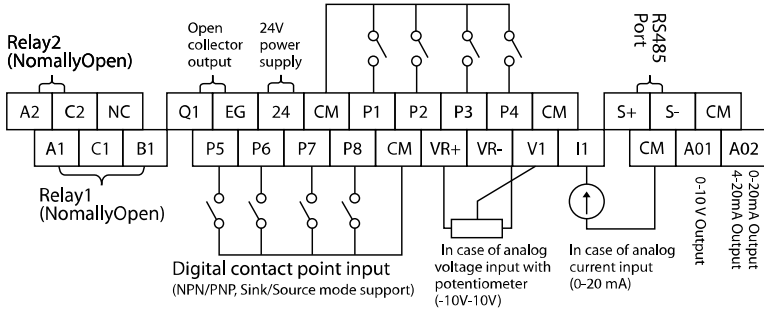

Note

- The TR (termination resistor) switch is used to terminate the RS485 network connection (120 Ω). Please turn on the TR switch of the last positioned Drive and turn off the TR switch of the remaining drives.
- Use a potentiometer rated for 0.5 W, 1 kΩ.

If the analog voltage (V) or current (I) input is used to set the frequency reference, the analog input is reflected when the input is actually received. For instance, the voltage input 0 V at V1 does not indicate that no input is received at V1, but it means that 0 V input is actually received at V1.

Note

When you use the analog voltage input, the bipolar input range (-10 – +10V), in comparison to the unipolar input range (0–10V), allows for more accurate input control with smaller increments.

⚠ Caution

If the analog input is interrupted when setting a frequency reference using the analog voltage (V) input and no voltage input is received at the terminal, an offset voltage may be applied to keep the frequency reference at approximately 4–5 Hz.

4.10 Terminal Inputs for Inverter Operation

Input Type	Symbol	Name	Description
Terminal input	P1–P8	Multi-function input1–8	Configurable for multi-function input terminals. Refer to 13 Table of Functions on page 399 for the multi-function terminal configurations.
	CM	Common sequence	Common terminal for terminal inputs (5G common terminal is used for analog frequency inputs only).
Analog input	VR(+)	Potentiometer frequency reference (+)	Used to setup or modify a frequency reference via the analog voltage or current input. Maximum output is +12 V, 100 mA.
	VR(-)	Potentiometer frequency reference (-)	Used to setup or modify a frequency reference via the analog voltage or current input. Maximum output is -12 V, 100 mA.

Connecting the Cables

Input Type	Symbol	Name	Description	
	V1	Voltage input for frequency reference	Used to setup or modify a frequency reference via the analog voltage input terminal. Unipolar: 0–10 V Bipolar: -10–10 V Input resistance 20 kΩ	
	I1	Current input for frequency reference	Used to setup or modify a frequency reference via the current input terminals. Input current: DC 0–20 mA Input resistance 249 Ω	
	5G	Frequency setting common terminal	Common terminal for analog voltage and current terminals (CM common terminal is used for terminal inputs only).	
Analog output	AO1	Multi-function analog voltage output terminal	Used to send inverter output information to external devices. Output voltage: 0–10 V Maximum output voltage: 10 V Maximum output current: 10 mA	
	AO2	Multi-function analog current output terminal	Used to send inverter output information to external devices. Output current: 4–20 mA (0–20 mA) Maximum output current: 20 mA	
Output Signal	Terminal output	Q1	Multi-function terminal (open collector)	DC 26 V, below 100 mA
		EG	Common terminal for open collector	Common ground contact for an open collector (with external power source).
		24	External 24 V power source	Maximum output current: 150 mA
	CM	External 24 V common	Common ground contact for the external 24 V power source.	
	A1, B1, C1	Fault signal output	Sends out alarm signals when the inverter's safety features are activated (below AC 250 V 5 A, DC 30 V 5 A). Fault condition: A1 and C1 contacts are connected (B1 and C1 open connection) Normal operation: B1 and C1 contacts are connected (A1 and C1 open connection)	
	A2, C2	Multi-function relay2 output A contact	Outputs the signal while running. User defined multi-function output terminal. (< AC 250 V, 5 A / < DC 30 V, 5 A)	
	S+, S-, CM	RS-485 signal line	Used to send or receive RS-485 signals. Refer to 11. Communication Function on page 351.	

4.11 Cable Specifications for Control Block Wiring

Terminal Name		Cable size ¹⁾		Specifications
		mm ²	AWG	
P1-P8	Multi-function input terminal	0.33- 1.25	16-22	-
CM	Common terminal input (5G common is used for analog frequency inputs only).			Common earth for multi-function input terminal
VR+	Analog frequency setting (+) power			Output voltage: +12 V Maximum output voltage: 100 mA
VR-	Analog frequency setting (-) power			Output voltage: -12 V Maximum output voltage: 100 mA
V1	Multi-function analog voltage input terminal			Input voltage: 0-10 V or -10-10 V
I1	Multi-function analog current input terminal			0-20 mA input Internal resistance: 249 Ω
AO1	Multi-function analog voltage output terminal	0.33- 2.0	14-22	Maximum output voltage: 10 V Maximum output current: 10 mA
AO2	Multi-function analog current output terminal			Maximum output current: 20 mA
5G	Frequency setting common terminal (CM common terminal is used for terminal inputs only).			Common terminal of analog frequency setting signal and analog current and voltage terminals
Q1	Multi-function terminal (open collector)			DC 26 V, below 100 mA
EG	Ground terminal for external power			Common terminal for an open collector external power source
24	External 24 V power supply			Maximum output current: 150 mA
CM	24 V common	0.33- 1.25	16-22	Common terminal for external 24 V power source
A1	Multi-function relay 1 output A			Below AC 250 V/5 A, Below DC 30 V/5 A
B1	Multi-function relay 1 output B	0.33- 2.0	14-22	Below AC 250 V/5 A, Below DC 30 V/5 A
C1	Multi-function relay 1 common terminal			Below AC 250 V/5 A, Below DC 30 V/5 A
A2	Multi-function relay 2 output A			Below AC 250 V/5 A, Below DC 30 V/5 A
C2	Multi-function relay 2 common terminal			Below AC 250 V/5 A, Below DC 30 V/5 A
S+,S-	RS485 signal input terminal			0.75
CM	RS485 common terminal	For multi-connections, RS485 power ground (shield) connection terminal		

1) Use shielded, twisted-pair cables.

4.12 Control Terminal Wiring for iS7 Extension I/O (Optional)

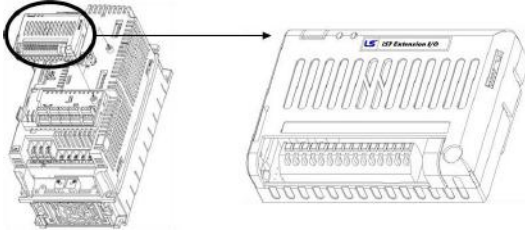

Extension I/O (control terminal block)

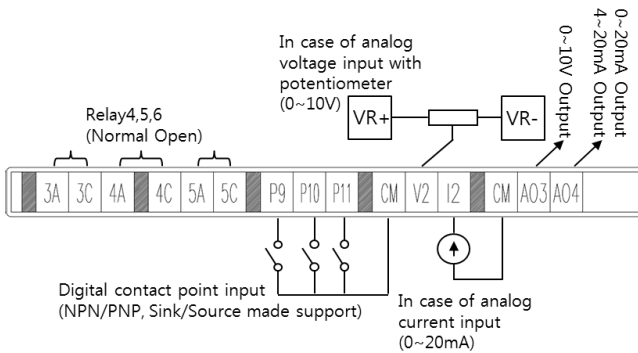
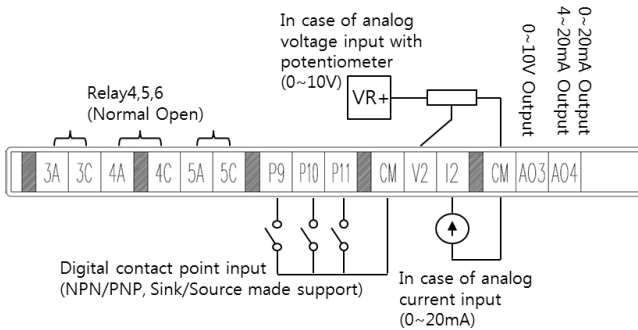

4.13 Terminal Inputs for Inverter Operation

Input Type	Symbol	Name	Description	
Input signal	Terminal input	P9-P11	Multi-function input9-11 Configurable for multi-function input terminals. Refer to <i>13 Table of Functions</i> on page 399 for the multi-function terminal configurations.	
		CM	Common sequence Common terminal for terminal inputs	
	Analog input	V2	Voltage input for frequency reference Used to setup or modify a frequency reference via the analog voltage input terminal. Unipolar: 0-10 V Bipolar: -10-10 V Input resistance 20 kΩ	
		I2	Current input for frequency reference Used to setup or modify a frequency reference via the current input terminals. Input current: DC 0-20 mA Input resistance 249 Ω	
Output Signal	Analog output	AO3	Multi-function analog voltage output terminal Used to send inverter output information to external devices. Output voltage: -10-10 V Maximum output voltage: 10 V Maximum output current: 10 mA	
		AO4	Multi-function analog current output terminal Used to send inverter output information to external devices. Output current: 4-20 mA (0-20 mA) Maximum output current: 20 mA	
	Terminal output	3A, 3C	Multi-function relay3 output A contact	Outputs the signal while running. User defined multi-function output terminal. (< AC 250 V, 5 A / < DC 30 V, 5 A)
		4A, 4C	Multi-function relay4 output A contact	
		5A, 5C	Multi-function relay5 output A contact	
		CM	External 24 V common Common ground contact for the external 24V power source.	

4.14 Cable Specifications for Control Block Wiring

Terminal Name		Cable size ¹⁾		Specifications
		mm ²	AWG	
P9- P11	Multi-function input terminal	0.33- 1.25	16-22	-
CM	Common terminal input (5G common is used for analog frequency inputs only).			Common earth for multi-function input terminal
V2	Multi-function analog voltage input terminal			Input voltage: 0-10 V or -10-10 V
I2	Multi-function analog current input terminal			0-20 mA input Internal resistance: 249 Ω
AO3	Multi-function analog voltage output terminal			Maximum output voltage: 10 V Maximum output current: 10 mA
AO4	Multi-function analog current output terminal			Maximum output current: 20 mA
CM	24 V common			Common terminal for external 24 V power source
3A	Multi-function relay 3 output A			Below AC 250 V/5 A, Below DC 30 V/5 A
3C	Multi-function relay 3 common terminal			Below AC 250 V/5 A, Below DC 30 V/5 A
4A	Multi-function relay 4 output A			Below AC 250 V/5 A, Below DC 30 V/5 A
4C	Multi-function relay 4 common terminal			Below AC 250 V/5 A, Below DC 30 V/5 A
5A	Multi-function relay 5 output A			Below AC 250 V/5 A, Below DC 30 V/5 A
5C	Multi-function relay 5 common terminal			Below AC 250 V/5 A, Below DC 30 V/5 A

2) Use shielded, twisted-pair cables.

4.15 Setting the Built-in Surge Filter

The iS7 series inverters have a built-in surge filter between the input phases and the ground connection to absorb and mitigate surge current. This filter consists of a Y-CAP and multiple varistors.

However, in a non-grounded power system where specific ground faults occur frequently, adequate measures are required to avoid inverter damage.

Refer to the following table for details on how to prevent damage to specific power systems.

Power supply system and ground type	Varistors and Y-CAP connection	Effect
Directly grounded system	2-pin connector (on)	Reduced voltage stress and noise
Non-grounded or impedance ground system	2-pin connector (off)	Reduced risk of inverter damage if ground fault occurs

Note

Not EMC Filter built-in type 0.75–22 KW (200/400 V) products do not support this function.

⚠ Caution

- You can deactivate the built-in surge filter if there is no risk of surge voltage occurring in the system.
- In order to prevent accidents, remove the jumper switch after the internal voltage of the inverter is completely discharged.

4.16 Activating or Deactivating the Surge Filter

4.16.1 iS7 30–75KW (400 V) Inverters

Contact LS ELECTRIC Customer Support and ask for assistance to deactivate the built-in surge filter for the 30–75 KW (400 V) inverters.

4.16.2 iS7 90–375 kW (400V) Inverters

Remove the keypad and the screws from the front cover, and then remove the front cover.

⚠ Caution

Be careful not to open the front cover with the keypad attached, as this can damage the keypad cable.

Refer to the figure below and locate the SCR snubber board. On the circuit board, activate or deactivate the surge filter by connecting the two jumper pins or breaking the connection between the two pins using a jumper plug. The filter is turned on when the jumper plug is installed, and it is turned off when the jumper plug is removed.

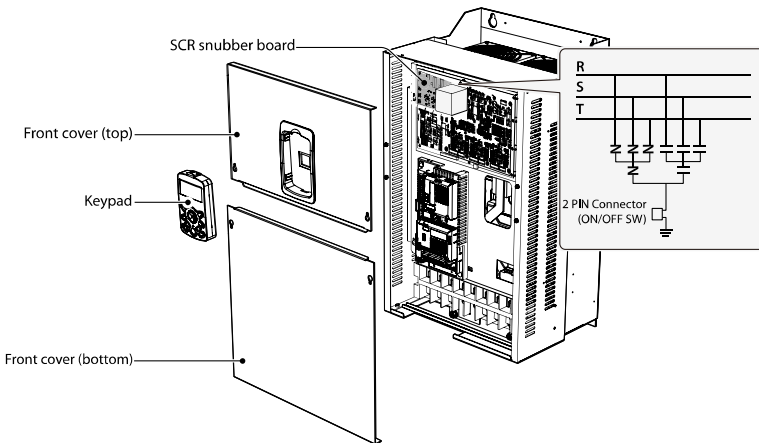

<Removing the front cover (Ex: 90–160 KW)>

Refer to the following figures to locate the jumper switch on the SCR snubber board and install or remove the jumper cap to activate or deactivate the built-in surge filter.

SV900-1600iS7 (400 V)

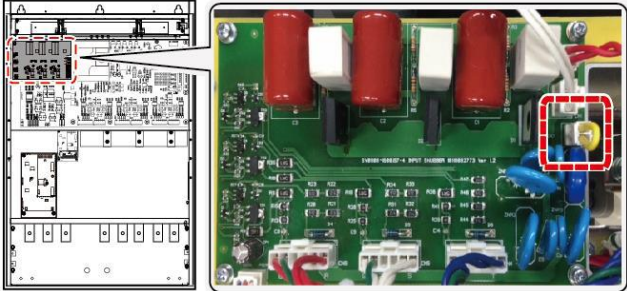

SV1850-2200iS7 (400 V)

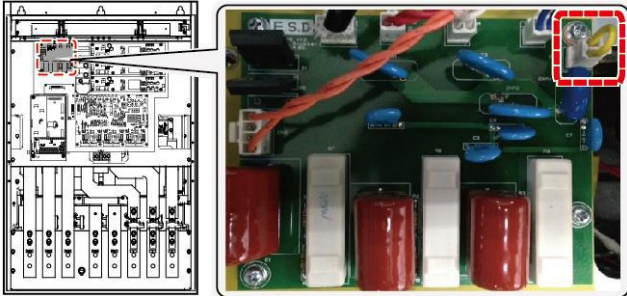

SV2800-3750iS7 (400 V)

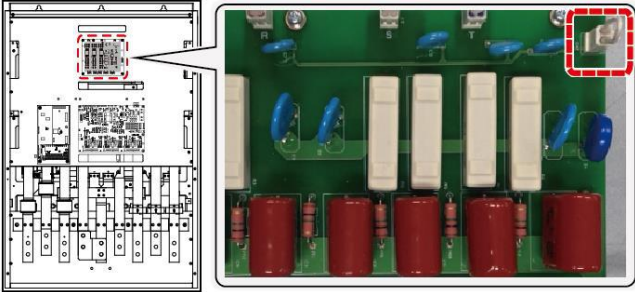

4.17 Post-Installation Checklist

After completing the installation, check the items in the following table to make sure that the inverter has been safely and correctly installed.

Items	Check Point	Result
Installation Location/Power I/O Verification	Is the installation location appropriate?	
	Does the environment meet the inverter's operating conditions?	
	Does the power source match the inverter's rated input?	
	Is the inverter's rated output sufficient to supply the equipment? (Certain circumstances will result in degraded performance.)	
Power Terminal Wiring	Is a circuit breaker installed on the input side of the inverter?	
	Is the circuit breaker correctly rated?	
	Are the power source cables correctly connected to the R/S/T terminals of the inverter? (Caution: connecting the power source to the U/V/W terminals may damage the inverter.)	
	Are the motor output cables connected in the correct phase rotation (U/V/W)? (Caution: motors will rotate in the reverse direction if three-phase cables are not wired in the correct phase rotation.)	
	Are the cables used in the power terminal connections correctly rated?	
	Is the inverter grounded correctly?	
	Are the power terminal screws and the ground terminal screws tightened to their specified torques?	
	Are the overload protection circuits installed correctly on the motors (if multiple motors are run using one inverter)?	
	Is the inverter separated from the power source by a magnetic contactor (if a braking resistor is in use)?	
	Are advanced-phase capacitors, surge protection, and electromagnetic interference filters installed correctly? (These devices MUST not be installed on the output side of the inverter.)	
Control Terminal Wiring	Are STP (shielded twisted pair) cables used for control terminal wiring?	
	Is the shielding of the STP wiring properly grounded?	
	If 3-wire operation is required, are the multi-function input terminals	

Items	Check Point	Result
	defined prior to the installation of the control wiring connections?	
	Are the control cables properly wired?	
	Are the control terminal screws tightened to their specified torques?	
	Is the total cable length of all control wiring < 328 ft (100 m) for model types rated at 3.7 kW and below, and 984 ft (300 m) for model types rated at more than 3.7 kW?	
	Is the total length of safety wiring < 100 ft (30 m)?	
Miscellaneous	Are optional modules connected correctly?	
	Is there any debris left inside the inverter?	
	Are any cables contacting adjacent terminals, creating a potential short circuit risk?	
	Are the control terminal connections separated from the power terminal connections?	
	Have the capacitors been replaced if they have been in use for > 2 years?	
	Has a fuse been installed for the power source?	
	Are the connections to the motor separated from other connections?	

Note

STP (Shielded Twisted Pair) cables have a highly conductive, shielded screen around twisted-pair cables. STP cables protect conductors from electromagnetic interference.

4.18 Test Run

When you turn on the iS7 inverter for the first time, it starts in Easy Start mode to help you configure the basic parameters required for inverter operation.

4.18.1 Entering Easy Start Mode

The inverter starts in Easy Start mode when you turn on the inverter for the first time, or when the inverter is turned on following a parameter initialization.

Note

- Before setting the parameter values for a user application, initialize the parameter settings to make sure that the default setting is applied to all parameters.
- If you initialized all parameters after an inverter trip occurred, the inverter starts in Easy Start mode after it is reset, regardless of the pending trip condition.
- Easy Start mode is not available while the inverter is already running.

4.18.2 Setting the Basic Parameters in Easy Start Mode

Refer to the following sequence table to understand the Easy Start sequence and configure the basic parameters according to the instructions.

Sequence	Instruction
Start Easy Set	Select "Yes" to start the inverter in Easy Start mode (select "No" to start the inverter in Monitor mode).
CNF-01 Language Sel	Select the keypad display language (only English is available at the moment).
DRV-14 Motor Capacity	Set the motor capacity. (Ex: 0.75 kW, 1.5 kW)
BAS-11 Pole Number	Set the number of poles in the motor.
BAS-15 Rated Volt	Set the rated motor voltage. Set this value to "0 V" if the rated motor voltage is identical to the input voltage.
BAS-10 60/50 Hz Sel	Set the rated motor frequency.
BAS19 AC Input Volt	Set the inverter input voltage.
DRV-06 Cmd Source	Set the source of the frequency reference. (Ex: KEYPAD, FX/RX-1, FX/RX-2, etc.)
DRV-01 Cmd Frequency	Set the frequency reference. (Ex: 50 Hz, 60 Hz, etc.)

Note

While you are in Easy Start mode, you can press the [ESC] key on the keypad to cancel Easy Start mode and enter Monitor mode.

4.18.3 Checking the Inverter Operation

⚠ Caution

Using an inverter, you can easily operate a motor at a high speed. Before operating a motor using an inverter, ensure that the set speed is within the motor's rated speed.

Follow the instructions to ensure that the motor operates correctly according to the inverter settings, and adjust the settings if required.

- 1 Set DRV-06 (CMD source) to "0 (KEYPAD)."
- 2 Set DRV-07 (Freq Ref Src) to "0 (Keypad-1)."
- 3 Set DRV-01 (CMD Frequency) to a temporary speed (Ex: 60 Hz).
- 4 Press the FWD key on the keypad, and ensure that the motor is rotating in the correct direction. When the forward command (Fx) is on, the motor should rotate counterclockwise when viewed from the load side of the motor. If the motor rotates in the reverse direction, switch the cables at the U and V terminals.

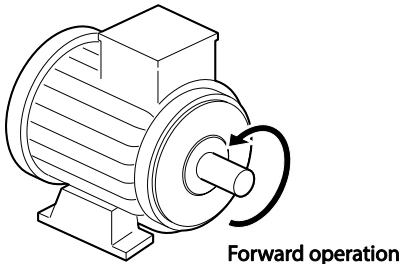

⚠ Caution

Ensure that the input power is within the inverter's rated input voltage range during operation.

5 Peripheral Devices

The reference diagram below shows a typical system configuration showing the inverter and peripheral devices.

Prior to installing the inverter, ensure that the product is suitable for the application (power rating, capacity, etc.). Also, ensure that all of the required peripherals and optional devices (resistor brakes, contactors, noise filters, etc.) are available.

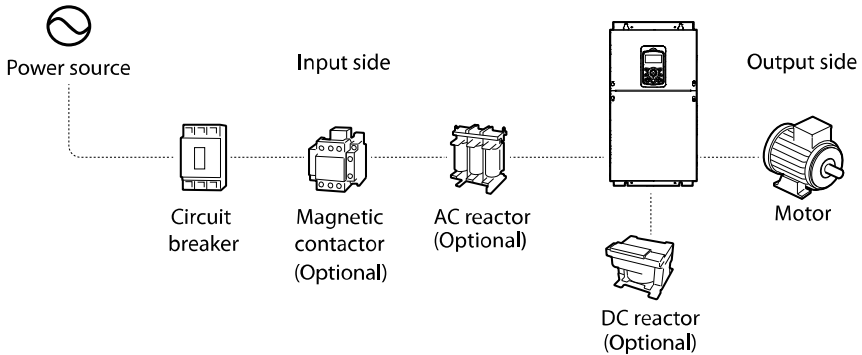

⚠ Caution

- Figures in this manual are shown with covers or circuit breakers removed to show a more detailed view of the installation arrangements. Install covers and circuit breakers before operating the inverter. Operate the product according to the instructions in this manual.
- Supply input power within the voltage range approved for the inverter's rating.
- Do not start or stop the inverter using a magnetic contactor installed in the input power supply.
- If the inverter is damaged and loses control, the machine may cause a dangerous situation. Install an additional safety device, such as an emergency brake, to prevent these situations.
- High levels of current draw during power-on can affect the system. Ensure that correctly rated circuit breakers are installed to operate safely during power-on situations.
- Reactors can be installed to improve the power factor. Note that reactors may be installed within 32.8 ft (10 m) of the power source if the input power exceeds 1000 kVA.
- 400 V class inverters require a motor with reinforced insulation. Micro surge voltages generated at the motor terminals may deteriorate the motor insulation.

5.1 Wiring Switch, Electronic Contactor, and Reactor Specifications

5.1.1 Wiring Switch, Short Circuit Switch, and Electronic Contactor

Inverter Capacity	Wiring Switch				Short Circuit Switch		Electronic Contactor	
	METASOL		SUSOL					
	Model	Rated current[A]	Model	Rated current[A]	Model	Rated current[A]	Model	Rated current[A]
0008IS7-2	ABS33c	15	UTE100	15	EBS33c	15	MC-9b	11
0015IS7-2	ABS33c	15	UTE100	15	EBS33c	15	MC-12b	13
0022IS7-2	ABS33c	30	UTE100	30	EBS33c	30	MC-18b	18
0037IS7-2	ABS33c	30	UTE100	30	EBS33c	30	MC-32a	32
0055IS7-2	ABS53c	50	UTS150	50	EBS53c	50	MC-40a	40
0075IS7-2	ABS63c	60	UTS150	60	EBS63c	60	MC-50a	55
0110IS7-2	ABS103c	100	UTS150	100	EBS103c	100	MC-65a	65
0150IS7-2	ABS103c	125	UTS150	125	EBS203c	125	MC-100a	105
0185IS7-2	ABS203c	150	UTS150	150	EBS203c	150	MC-130a	130
0220IS7-2	ABS203c	175	UTS250	175	EBS203c	175	MC-150a	150
0300IS7-2	ABS203c	225	UTS250	225	EBS203c	225	MC-150a	150
0370IS7-2	ABS403c	300	UTS400	300	EBS403c	300	MC-225a	225
0450IS7-2	ABS403c	350	UTS400	350	EBS403c	350	MC-330a	330
0550IS7-2	ABS603c	500	UTS600	500	EBS603c	500	MC-400a	400
0750IS7-2	ABS603c	630	UTS600	600	EBS603c	630	MC-630a	630
0008IS7-4	ABS33c	15	UTE100	15	EBS33c	15	MC-9b	9
0015IS7-4	ABS33c	15	UTE100	15	EBS33c	15	MC-9b	9
0022IS7-4	ABS33c	15	UTE100	15	EBS33c	15	MC-12b	12
0037IS7-4	ABS33c	15	UTE100	15	EBS33c	15	MC-18b	18
0055IS7-4	ABS33c	30	UTE100	30	EBS33c	30	MC-22b	22
0075IS7-4	ABS33c	30	UTE100	30	EBS33c	30	MC-32a	32
0110IS7-4	ABS53c	50	UTS150	50	EBS53c	50	MC-40a	40
0150IS7-4	ABS63c	60	UTS150	60	EBS63c	60	MC-50a	50
0185IS7-4	ABS103c	80	UTS150	80	EBS103c	75	MC-65a	65
0220IS7-4	ABS103c	100	UTS150	100	EBS103c	100	MC-65a	65
0300IS7-4	ABS103c	125	UTS150	125	EBS203c	125	MC-100a	105
0370IS7-4	ABS203c	150	UTS150	150	EBS203c	150	MC-130a	130
0450IS7-4	ABS203c	175	UTS250	175	EBS203c	175	MC-150a	150
0550IS7-4	ABS203c	225	UTS250	225	EBS203c	225	MC-185a	185
0750IS7-4	ABS403c	300	UTS400	300	EBS403c	300	MC-225a	225

Inverter Capacity	Wiring Switch				Short Circuit Switch		Electronic Contactor	
	METASOL		SUSOL					
	Model	Rated current[A]	Model	Rated current[A]	Model	Rated current[A]	Model	Rated current[A]
0900iS7-4	ABS403c	400	UTS400	400	EBS403c	400	MC-330a	330
1100iS7-4	ABS603c	500	UTS600	500	EBS603c	500	MC-400a	400
1320iS7-4	ABS603c	630	UTS600	600	EBS603c	630	MC-400a	400
1600iS7-4	ABS603c	630	UTS600	600	EBS603c	630	MC-630a	630
1850iS7-4	ABS803c	800	UTS800	800	EBS803c	800	MC-630a	630
2200iS7-4	ABS803c	800	UTS800	800	EBS803c	800	MC-800a	800
2800iS7-4	ABS1003b	1000	UTS1200	1000	EBS1003c	1000	1000A	1000
3150iS7-4	ABS1203b	1200	UTS1200	1200	EBS1203c	1200	1200A	1200
3750iS7-4	1400A	1400	1400A	1400	1400A	1400	1400A	1400

⚠ Caution

Only use Class H or RK5 UL listed input fuses and UL listed breakers. See the table above for the voltage and current ratings for the fuses and breakers.

Utiliser UNIQUEMENT des fusibles d'entrée homologués de Classe H ou RK5 UL et des disjoncteurs UL. Se reporter au tableau ci-dessus pour la tension et le courant nominal des fusibles et des disjoncteurs.

Note

- If you install the recommended reactors, you can maintain the power factor above 85%, and keep the THD below 40% for operations at the rated load. Improvements are reduced at lighter loads.
- Cable impedance affects the input power factor and occurrence of harmonic waves. The input power factor and THD improvement of the reactors may be lower depending on the transformer capacity, the transformer impedance, and the cable length.
- Refer to the specifications table and install recommended reactors. Although a higher inductance value (L) of the reactor results in an improvement in the power factor and better suppression of harmonic effects, power loss increases at the same time due to voltage drop.
- The capacity of built-in DC reactors in some iS7 inverter models is based on the normal duty load factor. Therefore, improvements may be reduced during a heavy duty operation.

5.1.2 Reactors

DC Reactor Specifications

The iS7 200 V/ 400 V 30–75 kW, 400 V/280–375 kW models are not supplied with a built-in DC reactor. Refer to the following specifications tables for different models to choose an appropriate DC reactor for your application.

<200V/30–75kW>

Inverter capacity	DC reactor specifications	
	mH	A
0300iS7-2	0.24	200
0370iS7-2	0.2	240
0450iS7-2	0.17	280
0550iS7-2	0.12	360
0750iS7-2	0.1	500

<400V/30–75kW>

(For Non-DCR products, remove the P1 and P2 shorting pins to install the DC reactor.)

Inverter capacity	DC reactor specifications	
	mH	A
0300iS7-4	0.98	75
0370iS7-4	0.87	90
0450iS7-4	0.55	110
0550iS7-4	0.47	150
0750iS7-4	0.48	180

<400V/280–375 kW>

Inverter capacity	DC reactor specifications	
	mH	A
2800iS7-4	0.09	836
3150iS7-4	0.076	996
3750iS7-4	0.064	1195

Note

All iS7 models, other than the 200 V/30–75 kW and 400 V/280–375 kW models, may be provided with an optional built-in DC reactor.

AC Reactor Specifications

You can install an AC reactor to prevent the capacitors and generators from overheating or being damaged when the power source voltage is unbalanced.

When you install an AC reactor, connect the AC reactor cables to the R, S, and T terminals on the inverter. Installation of an AC reactor is not necessary if a DC reactor is already installed in the inverter.

To avoid power loss resulting from the incorrect installation of an AC reactor, contact LS ELECTRIC Customer Support to ensure that your model type and application requires the installation of an AC reactor.

Refer to the following specifications tables to choose an appropriate AC reactor for your application.

Inverter capacity	AC reactor specifications			
	Heavy duty		Normal duty	
	mH	A	mH	A
0008IS7-2	2.13	5.7	1.20	10
0015IS7-2	1.20	10	0.88	14
0022IS7-2	0.88	14	0.56	20
0037IS7-2	0.56	20	0.39	30
0055IS7-2	0.39	30	0.28	40
0075IS7-2	0.28	40	0.20	59
0110IS7-2	0.20	59	0.15	75
0150IS7-2	0.15	75	0.12	96
0185IS7-2	0.12	96	0.10	112
0220IS7-2	0.10	112	0.07	160
0300IS7-2	0.07	160	0.05	200
0370IS7-2	0.05	200	0.044	240
0450IS7-2	0.044	240	0.038	280
0550IS7-2	0.038	280	0.026	360
0750IS7-2	0.026	360	0.02	500
0008IS7-4	8.63	2.8	4.81	4.8

Inverter capacity	AC reactor specifications			
	Heavy duty		Normal duty	
	mH	A	mH	A
0015IS7-4	4.81	4.8	3.23	7.5
0022IS7-4	3.23	7.5	2.34	10
0037IS7-4	2.34	10	1.22	15
0055IS7-4	1.22	15	1.14	20
0075IS7-4	1.14	20	0.81	30
0110IS7-4	0.81	30	0.61	38
0150IS7-4	0.61	38	0.45	50
0185IS7-4	0.45	50	0.39	58
0220IS7-4	0.39	58	0.287	80
0300IS7-4	0.287	80	0.232	98
0370IS7-4	0.232	98	0.195	118
0450IS7-4	0.195	118	0.157	142
0550IS7-4	0.157	142	0.122	196
0750IS7-4	0.122	196	0.096	237
0900IS7-4	0.096	237	0.081	289
1100IS7-4	0.081	289	0.069	341
1320IS7-4	0.069	341	0.057	420
1600IS7-4	0.057	420	0.042	558
1850IS7-4	0.042	558	0.042	558
2200IS7-4	0.042	558	0.029	799
2800IS7-4	0.029	799	0.029	799
3150IS7-4	0.029	799	0.024	952
3750IS7-4	0.024	952	0.024	952

5.1.3 Dynamic Braking Unit (DBU) and Resistor

Dynamic Braking Unit Specifications

UL form	Voltage	Capacity of applied motor	Braking unit	Reference-Terminal arrangement & dimensions
UL type	200 V	30–37 kW	SV370DBU-2U	Group 1
		45–55 kW	SV550DBU-2U	
		75 kW	SV370DBU-2U, 2Set	
	400 V	30–37 kW	SV370DBU-4U	
		45–55 kW	SV550DBU-4U	
		75 kW	SV750DBU-4U	
		90 kW	SV550DBU-4U, 2Set	
		110–132 kW	SV750DBU-4U, 2Set	
	400 V	160 kW	SV750DBU-4U, 3Set	
		45–55 kW, 75 kW	SV075DB-4	
185–220 kW			SV2200DB-4 Note 1)	Group 4
280–375 Kw	SV2200DB-4, 2Set			
Non UL type	200 V	30–37 kW	LSLV0370DBU-2LN	Group 5
			LSLV0370DBU-2HN	Group 6
		45–55 kW, 75 kW	LSLV0750DBU-2LN	Group 5
			LSLV0750DBU-2HN	Group 6
	400 V	30–37 kW	LSLV0370DBU-4LN	Group 5
			LSLV0370DBU-4HN	Group 6
		45–55 kW, 75 kW	LSLV0750DBU-4LN	Group 5
			LSLV0750DBU-4HN	Group 6
		90 kW	LSLV0900DBU-4HN	Group 6
		110–132 kW	LSLV1320DBU-4HN	
		160 kW	LSLV1600DBU-4HN	
		185–220 kW	LSLV2200DBU-4HN	
	280–375 kW	LSLV2200DBU-4HN, 2Set		

Note 1) For model types with a rated capacity of 180 kW and above, contact LS ELECTRIC Customer Support for detailed information.

Note

- The 0.75–22kW (200 V/400 V) models are provided with a built-in dynamic braking unit. Installation of additional dynamic braking units is not necessary for these models.
- Refer to the instruction manual provided by the manufacturer before installing a dynamic braking unit. There may be specification changes that are not reflected in the table provided with this manual.
- For detailed specifications of UL type DB units, such as resistance/wattage/braking torque/%ED, refer to the table in [5.1.6 DB Resistors](#) on page [102](#). For non UL type DB units, refer to the instruction manual provided by the manufacturer.

DBU Terminal Arrangement

Group 1					Group 2			
P	N	G	B1	B2	G	N	B2	P/B1

Terminal	Description
G	Ground Terminal
B2	Connect to the B2 terminal of a braking resistor.
B1	Connect to the B1 terminal of a braking resistor.
N	Connect to the N terminal of an inverter.
P	Connect to the P1 terminal of an inverter.

Peripheral Devices

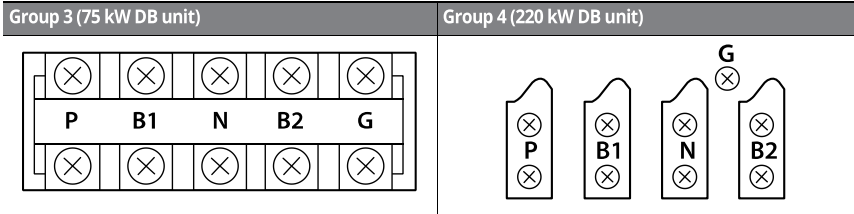

Terminal	Description
G	Ground Terminal
B2	Connect to the B2 terminal of a braking resistor.
B1	Connect to the B1 terminal of a braking resistor.
N	Connect to the N terminal of an inverter.
P	Connect to the P terminal of an inverter.

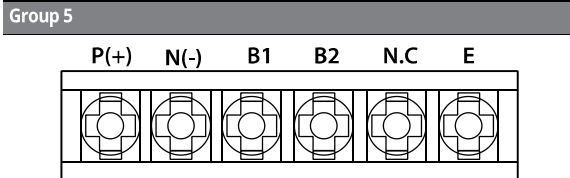

Terminal	Description
P(+)	Connect to the P terminal of an inverter.
N(-)	Connect to the N terminal of an inverter.
B1	Connect to the B1 terminal of a braking resistor.
B2	Connect to the B2 terminal of a braking resistor.
N.C	Not used
E	Ground terminal

Group 6

A frame (37 kW, 75 kW-4)

B/C frame (75 kW-2, 90-220 kW)

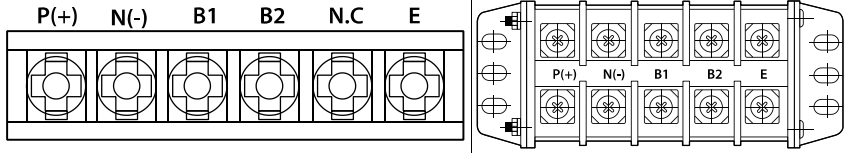

Terminal	Description
P (+)	Connect to the P terminal of an inverter (DC bus).
N (-)	Connect to the N terminal of an inverter (DC bus).
B1	Connect to the B1 terminal of an external braking resistor.
B2	Connect to the B2 terminal of an external braking resistor.
N.C	Not used
E	Ground terminal

Note

Refer to the instruction manual that is supplied with the DB unit to choose appropriate DB resistors for installation.

Basic Wiring Connection for the DB Unit and DB Resistor

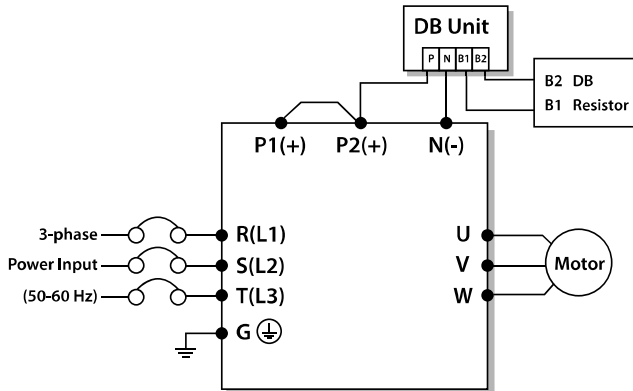

DB Unit Terminal	Description
B1	Connect to the B1 terminal of a DB resistor.
B2	Connect to the B2 terminal of a DB resistor.

5.1.4 DB Unit Dimensions

Group 1

M4–M5 Mounting

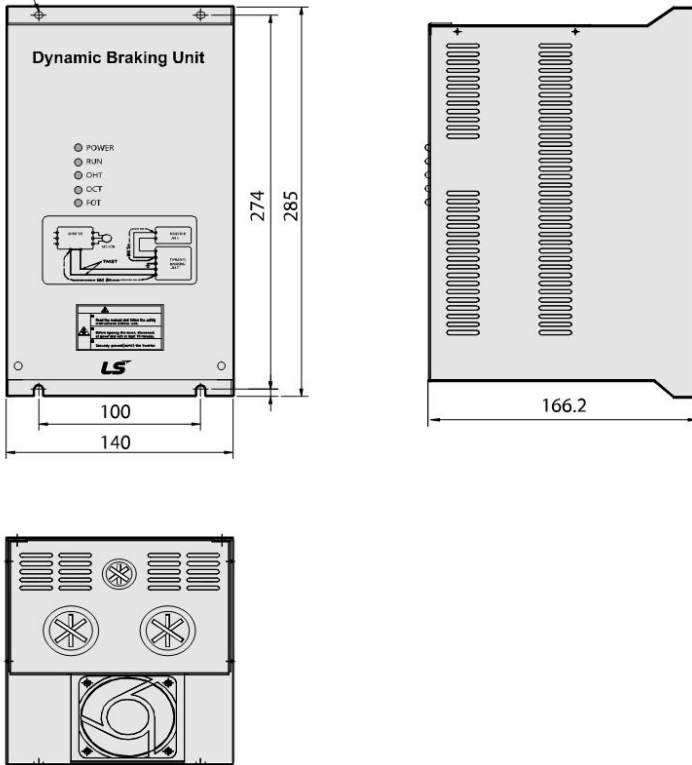

Group 2

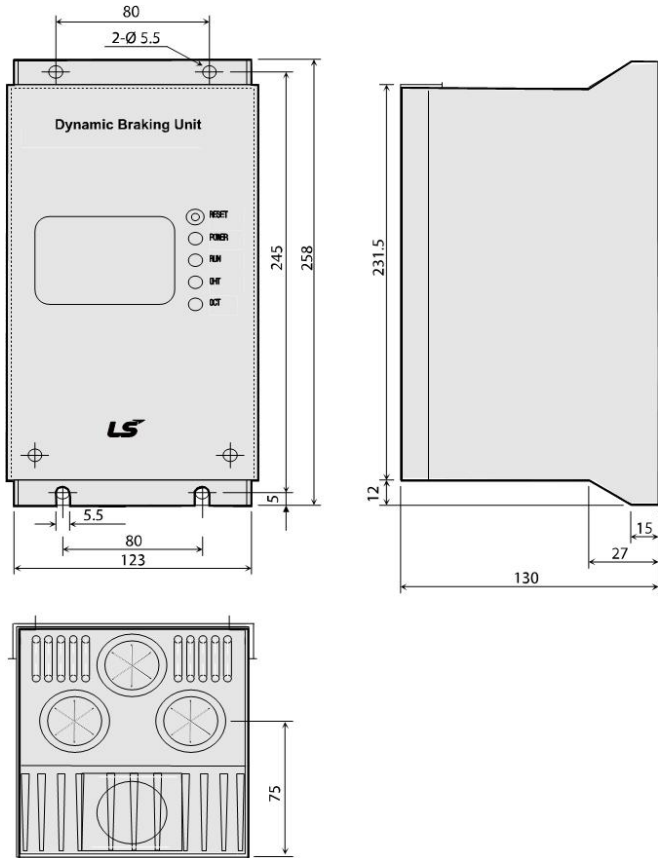

Group 3

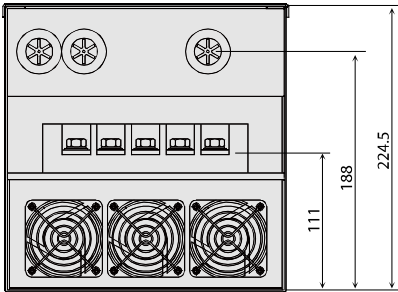
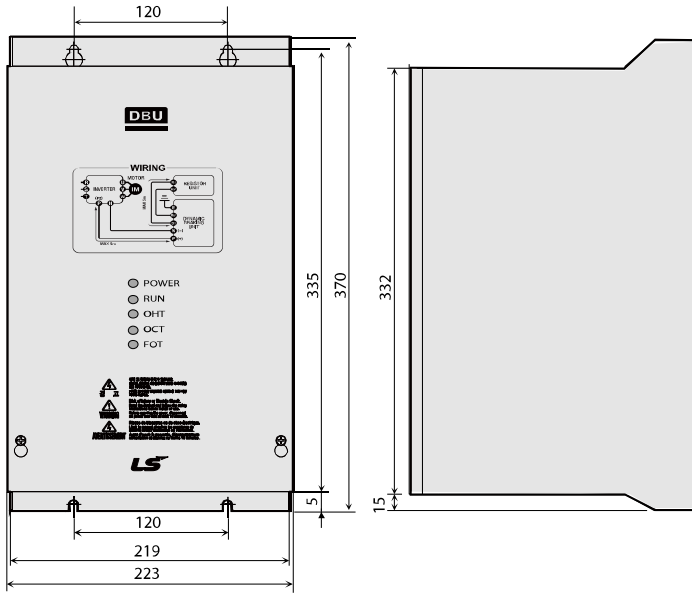

Group 4

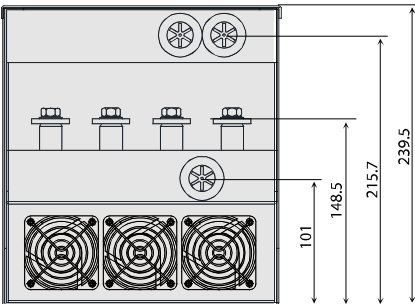
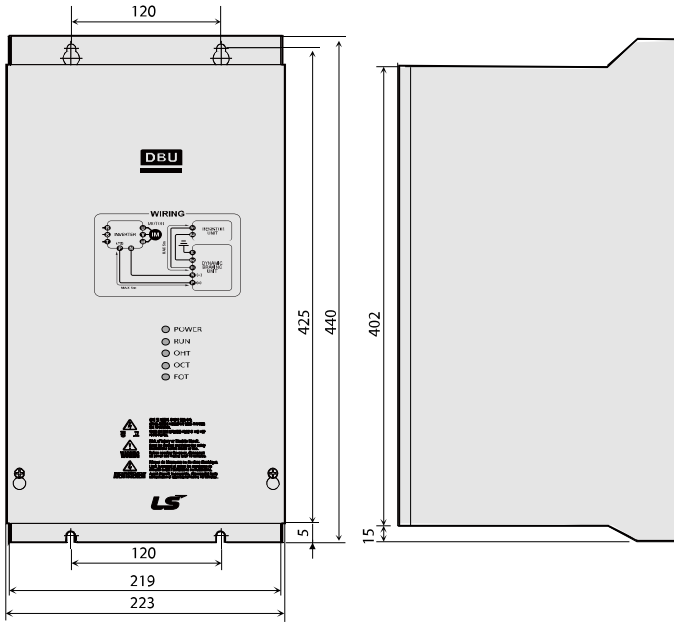

Group 5

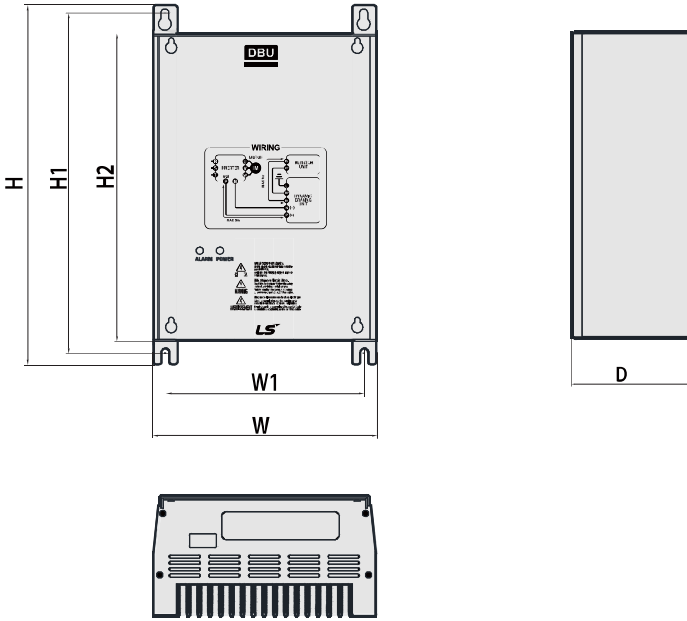

Voltage	Motor capacity	Dimensions (mm)				Hole position		Weight	Hole size
		W	H	H2	D	W1	H1		
220	15	140	227.4	192	76.4	125	215.4	1.50	M4
	22							1.55	
	37							1.57	
	75							1.84	
440	15	140	227.4	192	76.4	125	215.4	1.53	M4
	22							1.55	
	37							1.56	
	75							1.85	

Group 6

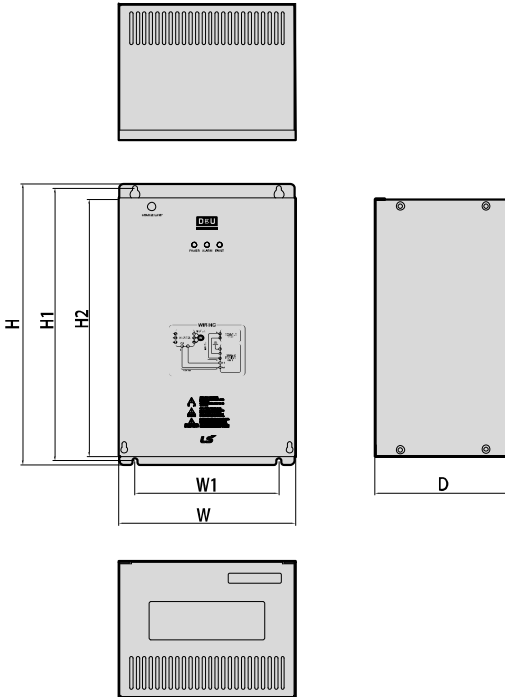

Frame	Voltage	Motor capacity	%ED	Dimensions (mm)				Hole position		Weight	Hole size
	[V]	[kW]		W	H	H2	D	W1	H1	[kg]	(ϕ)
A	220	37	50	200	219	190	165.2	160	208.5	3.77	M6
	440	37	50							3.84	
		75	50							3.98	
B	220	75	50	215	340	311		175	329.5	8.26	
		90	50							8.48	
	440	90	50							8.30	
		132	50							8.40	
C	440	160	50	240	380	351		200	369.5	9.40	
		220	50							9.70	

5.1.5 Indicators on the DB unit

On a DB unit, there are three LED indicators (one red and two green indicators) that indicate the operating condition of the DB unit.

Indicator name	Color	Location	Description
Power indicator	Red	Middle	Turns on when the main power is supplied to the unit (if a DB unit is connected to an inverter, the power indicator is turned on when the main power is supplied to the inverter).
RUN indicator	Green	Right	Turns on when the DB unit is regenerating.
OHT indicator	Green	Left	Turns on when the overheating protection function is enabled. If the DB unit temperature exceeds the maximum allowed operating temperature, the overheating protection function is activated to cut off the input to the DB unit (the power indicator on the DB unit is turned off).

5.1.6 DB Resistors

The following table lists type A DB unit specifications for your reference. For type B and type C DB unit specifications, refer to the instruction manuals that are supplied with the DB units.

Before installing a DB resistor, refer to the instruction manuals provided by the manufacturer to choose an appropriate type of DB resistor.

Note

When you double the duty cycle (%ED) of a DB unit, the wattage ratings of the optional DB resistor must be doubled accordingly.

Inverter capacity (kW)	Resistance [ohm]	Wattage [W]	Type	Reference	Wiring [mm ²]	Model Type		
200V Class	0.75	150	150	-	150% braking torque, 5%ED	1.25	-	
	1.5	60	300	-		1.25	-	
	2.2	50	400	TYPE 1		2.5	MCRF400W50	
	3.7	33	600	TYPE 2		2.5	MCRF600W33	
	5.5	20	800	TYPE 3		2.5	MCRF800W20	
	7.5	15	1200	TYPE 5		4	MCRF1200W15	
	11	10	2400	TYPE 6		4	MCRF-ST2400W10	
	15	8	2400	TYPE 6		10	MCRF-ST2400W8	
	18.5	5	3600	TYPE 7		20	MCRF-ST3600W5	
	22	5	3600	TYPE 7		20	MCRF-ST3600W5	
400V Class	30	5	5000	-	100% braking torque, 10%ED	-	-	
	37	4.5	7000	-		-	-	
	45	3.5	10000	-		-	-	
	55	3.0	15000	-		-	-	
	75	2.5	20000	-		-	-	
	600V Class	0.75	600	150		-	150% braking torque, 5%ED	1.25
1.5		300	300	-	2	-		
2.2		200	400	TYPE 1	2.5	MCRF400W200		
3.7		130	600	TYPE 2	2.5	MCRF600W130		
5.5		85	1000	TYPE 4	2.5	MCRF1000W85		
7.5		60	1200	TYPE 5	2.5	MCRF1200W60		
11		40	2000	TYPE 6	2.5	MCRF-ST2000W40		
15		30	2400	TYPE 6	4	MCRF-ST2400W30		
18.5		20	3600	TYPE 7	6	MCRF-ST3600W20		
22		20	3600	TYPE 7	6	MCRF-ST3600W20		
30		16.9	6,400	-	100% braking torque, 10%ED	-		-
37		16.9	6,400	-		-		-
45		11.4	9,600	-		-		-
55		11.4	9,600	-		-		-
75	8.4	12,800	-	-		-		
90	4.5	15,000	-	-		-		
110	3.5	17,000	-	-		-		
132	3,0	20,000	-	-		-		

Peripheral Devices

Inverter capacity (kW)	Resistance [ohm]	Wattage [W]	Type	Reference	Wiring [mm ²]	Model Type
160	2.5	25,000	-		-	-
185	2	30,000	-		-	-
220	2	30,000	-		-	-
280	1.5	40,000	-		-	-
315	1	60,000	-		-	-
375	1	60,000	-		-	-

⚠ Caution

- If you install multiple DB units in parallel, the combined resistance value must match the resistance value in the table above.
- If an appropriate braking resistor type is not listed in the table, find a braking resistor with equivalent resistance and wattage values that are suggested in the table above.

5.1.7 DB Resistor Dimensions

TYPE 1,2,3,4,5 (Maximum 1200 Watts)

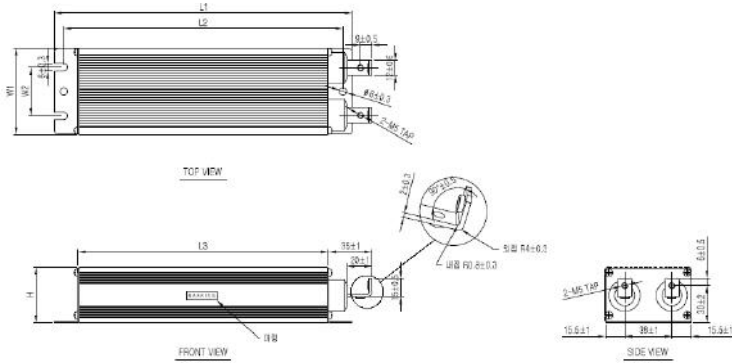

TYPE	Size [mm]					
	W	H	D	A	B	C
1	220	175	152	70	39	45
2	260	245	222	70	39	45
3	300	285	262	70	39	45
4	340	325	302	70	39	45
5	400	385	362	70	39	45

TYPE 6 (Maximum 2400 Watts)

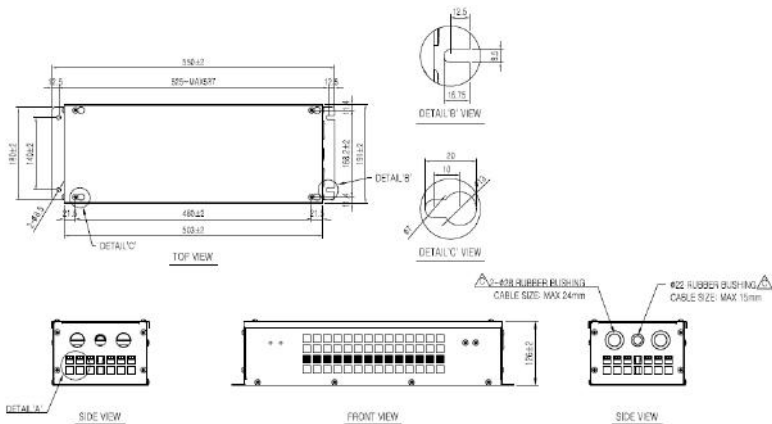

Peripheral
Devices

TYPE 7 (Maximum 3600 Watts)

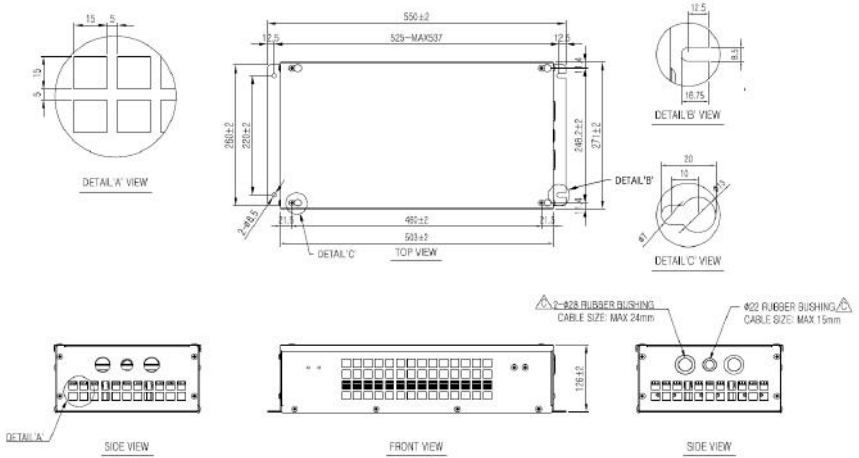

5.1.8 Keypad Extension Cable for Remote Control (Optional)

Included items

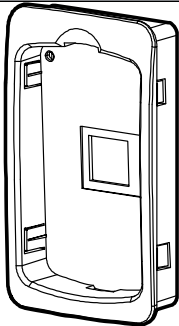
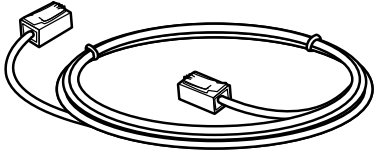
Items	
 <p>Keypad bracket</p>	 <p>Remote cable (2 m/3 m)</p>

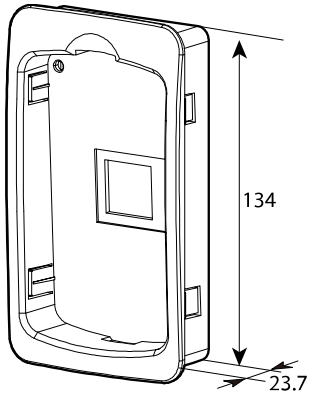
Keypad Bracket Dimensions**Remote Cable Specifications**

Model type	Part name
64110009	INV, iS7 REMOTE CABLE (2 M)
64110010	INV, iS7 REMOTE CABLE (3 M)

Installing the Remote Cable

Refer to the following figure to install the remote cable to extend the keypad cable length.

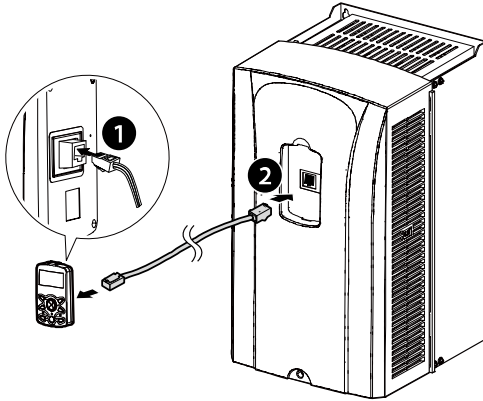

If a "Line Check" message is displayed on the keypad display and the keypad is not operating correctly after installing the remote cable, check the cable connection on both sides.

⚠ Caution

Do not extend the keypad cable using a third-party extension cable. The keypad may not operate correctly due to voltage drop and electromagnetic interference.

Note

- Ensure that the cable length between the keypad and the inverter does not exceed 10 ft (3.04 m). Cable connections longer than 10 ft (3.04 m) may cause signal errors.
- Install a ferrite clamp to protect signal cables from electromagnetic interference (Ex. Würth Electronics ferrite clamp PN742732).

6 Using the Keypad

6.1 About the Keypad

A keypad is used to set inverter parameters, monitor the inverter's status, and operate the inverter.

6.1.1 Dimensions

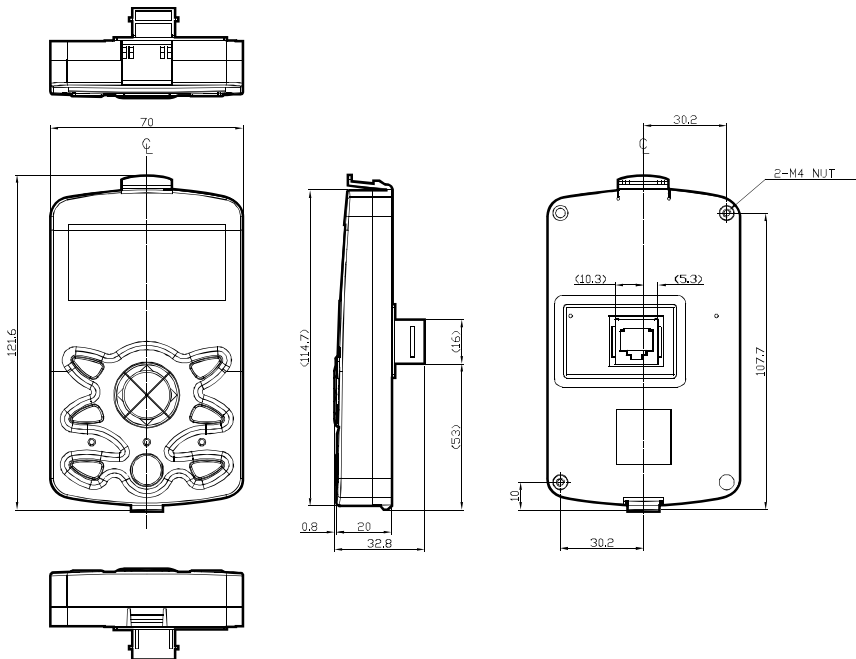

6.1.2 Key Functions

The following table lists the names and functions of the keypad's operation keys.

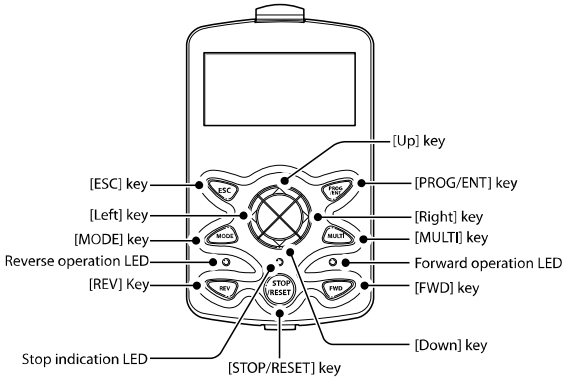

Section	Buttons	Key Name	Function Description
KEY		[MODE] key	Used to switch between modes.
		[PROG/ENT] key	If this button is pressed once, the parameter can be edited at the status of the editable parameter code. If this button is pressed after modification, it will save the modified data.
		[Up] key	Switch between codes, or increase or decrease parameter values.
		[Down] key	
		[Left] key	Switch between groups or move the cursor during parameter setup or modification.
		[MULTI] key	Used to register jog or user codes.
		[ESC] key	If you press this key before pressing the [PROG / ENT] key, it will revert the parameter value to the previous value. If you press this key while editing the codes in any function group, the keypad will display the first code of the function group. If you press this key while moving through the modes, the keypad will display Monitor mode.
		[FWD] key	Used to operate the motor in the forward direction.
		[REV] key	Used to operate the motor in the reverse direction.
		[STOP/RESET] key	Used to stop the operation and release a fault.

6.1.3 Display Items

Monitor Mode

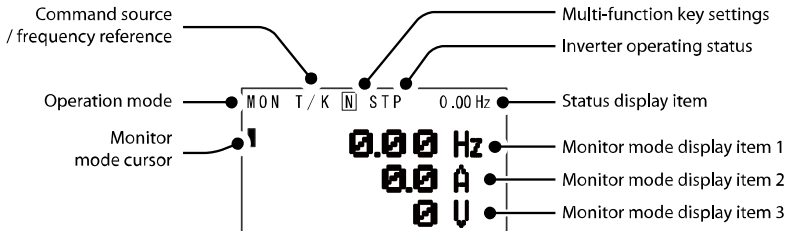

Parameter Mode

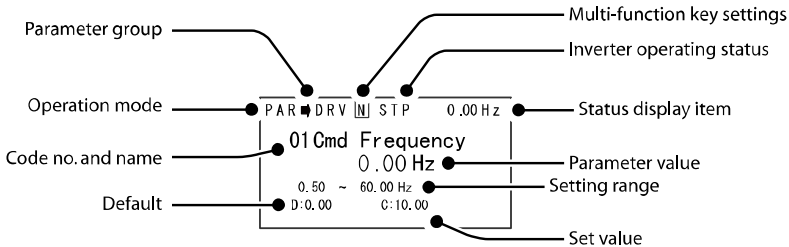

6.1.4 Display Item List

The following table lists the items in the display.

Item	Description
Mode display items	Displays the current mode's display items. For more details, refer to 6.3 Navigating Modes on page 117 .

Item	Description
Parameter group items	Displays the current parameter group's items. For more details, refer to 6.4 Navigating Modes and Parameters on page 120.
Command source / frequency reference items	Displays the types of sequences and the number of steps during an auto sequence operation.
Status display items	Displays the output frequency, output voltage, and current. For more details, refer to 6.1.3 Display Items on pages 111.
Monitor mode display items	Displays the current operation status. For more details, refer to 6.1.3 Display Items on pages 111.

Monitor display items

The following table lists display icons and their names and functions.

No	Function	Display	Description
1	Operation mode	MON	Monitor mode
		PAR	Parameter mode
		U&M	User-defined and Macro mode
		TRP	Trip mode
		CNF	Configuration mode
2	Command source	K	Keypad operation command
		O	FieldBus communication option operation command
		A	Application option operation command
		R	Built-in 485 operation command
		T	Terminal block operation command
3	Frequency reference	K	Keypad frequency command
		V	V1 input frequency command
		I	I1 input frequency command
		P	Pulse input frequency command
		U	Frequency command during UP operation (Up-Down operation)
		D	Frequency command during DOWN operation (Up-Down operation)
		S	Frequency command during STOP operation (Up-Down operation)
		O	FBus Option frequency command
		X	V2 and I2 frequency commands for sub-terminal block

No	Function	Display	Description
		J	Jog frequency command
		R	Internal 485 frequency command
		1-9 A-F	Multi-step frequency command
4	Multi-function key settings	JOG key	Used to switch to Keypad JOG mode
		Local/Remote	Used to select local or remote operation
		User Group Select key	Used to register parameters as a user group in Parameter mode or delete parameters in the user group.
5	Inverter operating status	STP	Motor stopped
		FWD	Operating in the forward direction
		REV	Operating in the reverse direction
		DC	DC output
		WAN	Warning
		STL	Stalling
		SPS	Speed Search
		OSS	Software over current controlled
		OSH	Hardware over current controlled
TUN	Auto tuning		

*OSS / OSH may cause overcurrent when the load is too large or when the acceleration/deceleration time is short. The inverter monitors the output current so that an overcurrent trip does not occur and also performs overcurrent suppression.

At this time, the output frequency is automatically changed to reduce the output current or the inverter output is temporarily cut off to prevent overcurrent.

6.2 Menu Items

The SV-IS7 series inverter uses 5 modes to monitor or configure different functions. Each mode has its own function items suitable for the desired properties. The parameters in Parameter mode and User & Macro mode are divided into smaller groups of relevant functions.

Press the [MODE] key to navigate between groups.

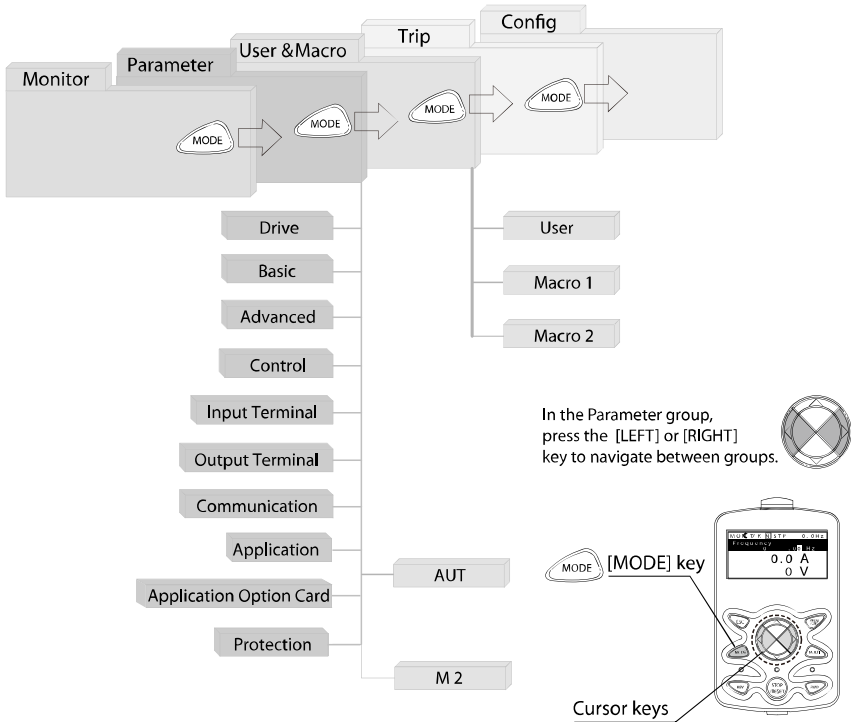

Mode	Display	Description
Monitor mode	MON	Displays the inverter's operation status information. You can monitor the frequency setting, operating frequency display, output current, voltage, etc.
Parameter mode	PAR	Used to configure the functions required to operate the inverter. These functions are divided into 12 groups based on purpose and complexity.
User & Macro mode	U&M	Used to define User and Macro groups. These user-definable groups allow specific functions of the inverter to be grouped and managed in separate groups. This mode will not be displayed when navigating through modes if no User groups or Macro groups have been defined.
Trip mode	TRP	Used to monitor the inverter's fault trip information, including the previous fault trip history. When a fault trip occurs during inverter operation, the operation frequency, output current, and output voltage of the inverter at the time of the fault can be monitored. This mode will not be displayed if the inverter is not at fault and a fault trip history does not exist.
Configuration mode	CNF	Used to configure the inverter features that are not directly related to the operation of the inverter. The settings you can configure in Configuration mode include keypad display language options, monitor mode environment settings, communication module display settings, and parameter duplication and initialization.

6.2.1 Parameter Mode

Mode	Display	Description
Drive group	DRV	Includes frequency/acceleration/deceleration time setting, operation command selection, etc.
Basic group	BAS	Configures basic operation parameters. These parameters include motor parameters and multi-step frequency parameters.
Advanced function group	ADV	Configures acceleration or deceleration, patterns, and frequency limits.
Control function group	CON	Configures functions related to sensorless and vector control.
Input terminal function group	IN	Configures input terminal-related features, including digital multi-functional inputs and analog inputs.

Using the Keypad

Mode	Display	Description
Output terminal function group	OUT	Configures the inverter output terminal block-related features, including the relay and analog outputs.
Communication function group	COM	Configures the communication features for the RS-485, if one is installed.
Application function group	APP	Configures the features related to PID control and auto sequence operation.
Auto Sequence run group	AUT	Configures the necessary features for auto sequence operation. This group will be displayed if the auto sequence operation in the APP group is selected.
Application option group	APO	Configures the encoder and PLC option module-related features if they are installed.
Protection group	PRT	Configures motor and inverter protection features.
Motor 2 function group (Motor 2)	M2	Configures the secondary motor-related features. This group will be displayed when Motor #2 is selected from the multi-function input terminal functions.

6.2.2 User & Macro Mode

Group	Display	Description
User group	USR	Used to group frequently accessed function parameters. User parameter groups can be configured using the multi-function key on the keypad.
Macro group	MCx	This provides different factory preset groups of functions based on the type of load. Group MC1, MC2, or MC3 will be displayed when the user selects the desired load type. Macro groups can be selected in CNF mode. For more details, refer to 11.12 Parameter Group for Transmission of Macro Group and User Group at U&M Mode on page 361.

6.3 Navigating Modes

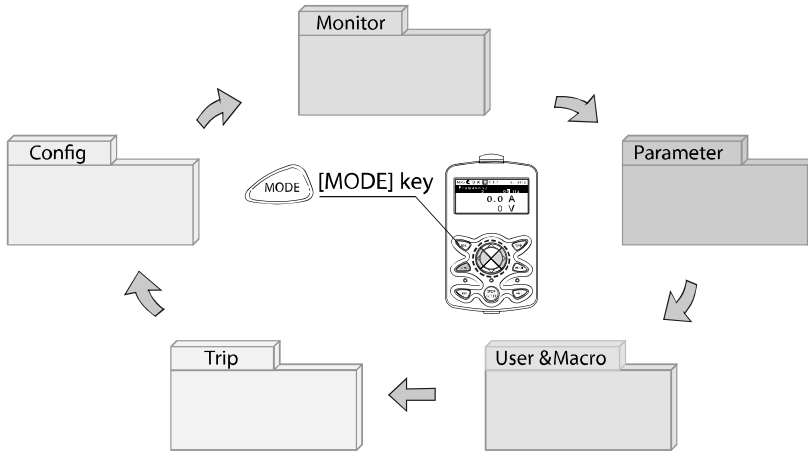

6.3.1 Mode Navigation at the Factory Default

You can change the display to navigate modes by using the [MODE] key. The User & Macro Mode and Trip Mode are not displayed when the inverter is set to the factory default settings. For more details, refer to [11.12 Parameter Group for Transmission of Macro Group and User Group at U&M Mode](#) on page 361.

```

MON T/K [N] STP 0.00Hz
|  0.00 Hz
  0.0 A
  0 V
  
```

- Displays when the inverter is powered on. This is the display of Monitor mode (MON).
- Press the [MODE] key.

<p>PAR →DRV [N] STP 0.00Hz 00 Jump Code 9 CODE 01 Cmd Frequency 0.00 Hz 02 Cmd Torque 0.0 %</p>	<ul style="list-style-type: none"> You are now in Parameter mode (PAR). Press the [MODE] key.
<p>CNF [N] STP 0.00Hz 00 Jump Code 40 CODE 01 Language Sel English 02 LCD Contrast ██████████</p>	<ul style="list-style-type: none"> You are now in Config mode (CNF). Press the [MODE] key.
<p>MON T/K [N] STP 0.00Hz █ 0.00 Hz 0.0 A 0 V</p>	<ul style="list-style-type: none"> You are now in Monitor mode again.

6.3.2 Mode Navigation with User/Macro Mode and Trip Mode

If you register a user code or set the macro function using the [MULTI] key, the User & Macro mode will be displayed, unlike the factory default settings during mode navigation. In addition, when a trip occurs during operation, Trip mode will be displayed. The trip information will also be saved in the trip mode history if you release the trip using the RESET function. The two modes for mode navigation are as follows.

<p>MON T/K [N] STP 0.00Hz █ 0.00 Hz 0.0 A 0 V</p>	<ul style="list-style-type: none"> Displays when the inverter is powered on. This is the display of Monitor mode (MON). Press the [MODE] key.
--	---

<pre> PAR →DRV [N] STP 0.00Hz 00 Jump Code 9 CODE 01 Cmd Frequency 0.00 Hz 02 Cmd Torque 0.0 % </pre>	<ul style="list-style-type: none"> You are now in Parameter mode (PAR). Press the [MODE] key.
<pre> U&M →USR [N] STP 0.00Hz 00 Jump Code 9 CODE 01 Cmd Frequency 0.00 Hz 02 Cmd Torque 0.0 % </pre>	<ul style="list-style-type: none"> You are now in User & Macro mode (U&M). Press the [MODE] key.
<pre> TRP Last-1 00 Trip Name (1) External Trip 01 Output Freq 0.00 Hz 02 Output Current 0.0 A </pre>	<ul style="list-style-type: none"> You are now in Trip mode (TRP). Press the [MODE] key.
<pre> CNF [N] STP 0.00Hz 00 Jump Code 40 CODE 01 Language Sel English 03 LCD Contrast ████████████████████ </pre>	<ul style="list-style-type: none"> You are now in Config mode (CNF). Press the [MODE] key.
<pre> MON T/K [N] STP 0.00Hz 0.00 Hz 0.0 A 0 U </pre>	<ul style="list-style-type: none"> You are now in Monitor mode again.

6.4 Navigating Modes and Parameters

You can navigate modes by using the [Left] or [Right] keys after navigating to the Parameter Mode or User & Macro Mode via the [Mode] key.

Press the [MODE] key to navigate through modes.
Ex) Monitor -> Parameter

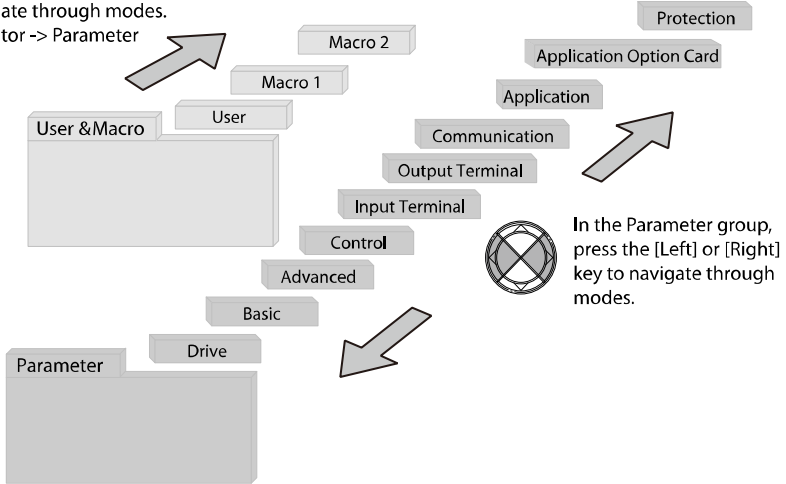

6.4.1 Group Navigation in Parameter mode

If you press the [Right] key in Parameter mode, the display will change as shown below. If you press the [Left] key, the display order will be reversed.

	<ul style="list-style-type: none"> • Displays when the inverter is powered on. This is the display of Monitor mode (MON). • Press the [MODE] key.
--	---

<pre> PAR →DRV [N] STP 0.00Hz 00 Jump Code 9 CODE 01 Cmd Frequency 0.00 Hz 02 Cmd Torque 0.0 % </pre>	<ul style="list-style-type: none"> You are now in Parameter mode (PAR). The Drive Group (DRV) of Parameter mode is displayed. Press the [Right] key.
<pre> PAR →BAS [N] STP 0.00Hz 00 Jump Code 20 CODE 01 Aux Ref Src None 02 Cmd 2nd Src Fx/Rx-1 </pre>	<ul style="list-style-type: none"> You are now in the Basic Function Group (BAS). Press the [Right] key.
<pre> PAR →ADV [N] STP 0.00Hz 00 Jump Code 24 CODE 01 Acc Pattern Linear 02 Dec Pattern Linear </pre>	<ul style="list-style-type: none"> You are now in the Advanced Function Group (ADV). Press the [Right] key 7 times.
<pre> PAR →PRT [N] STP 0.00Hz 00 Jump Code 40 CODE 01 Load Duty Heavy Duty 02 Phase Loss Chk [][] </pre>	<ul style="list-style-type: none"> The group sequence will change and the Protection Function Group (PRT) will be displayed. Press the [Right] key.
<pre> PAR →DRV [N] STP 0.00Hz 00 Jump Code 9 CODE 01 Cmd Frequency 0.00 Hz 02 Cmd Torque 0.0 % </pre>	<ul style="list-style-type: none"> You are now in the Drive group (DRV) of the Parameter group again.

6.4.2 Group Shift in User & Macro Mode

To navigate to User & Macro Mode, the user code should be registered or the macro function should be selected. For more details on how to register the user code and macro group, refer to *11.12 Parameter Group for Transmission of Macro Group and User Group at U&M Mode* on page 361. If the user code is registered and the macro function is selected, you can navigate to the group as shown below.

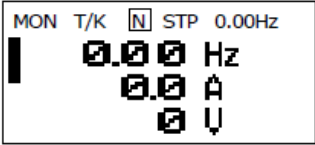
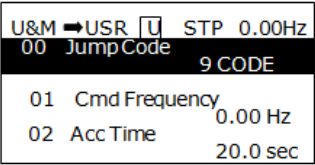
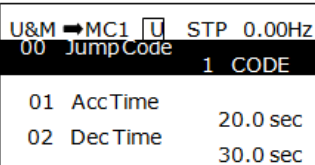
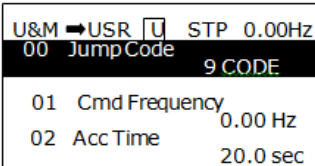
 <p>MON T/K [N] STP 0.00Hz 0.00 Hz 0.0 A 0 U</p>	<ul style="list-style-type: none"> • Displays when the inverter is powered on. This is the display of Monitor mode (MON). • Press the [MODE] key twice.
 <p>U&M →USR [U] STP 0.00Hz 00 JumpCode 9 CODE 01 Cmd Frequency 0.00 Hz 02 Acc Time 20.0 sec</p>	<ul style="list-style-type: none"> • You are now in the User & Macro mode (U&M). • The User Group (USR) is displayed. • Press the [Right] key.
 <p>U&M →MC1 [U] STP 0.00Hz 00 JumpCode 1 CODE 01 AccTime 20.0 sec 02 Dec Time 30.0 sec</p>	<ul style="list-style-type: none"> • You are now in the Macro group (MC1). • Press the [Right] key.
 <p>U&M →USR [U] STP 0.00Hz 00 JumpCode 9 CODE 01 Cmd Frequency 0.00 Hz 02 Acc Time 20.0 sec</p>	<ul style="list-style-type: none"> • You are now in the User Group (USR) again.

6.5 Navigating through Codes (Function Items)

6.5.1 Code Navigation in Monitor Mode

To display the frequency, output current, and output voltage, press the [Up] or [Down] keys to scroll through the items.

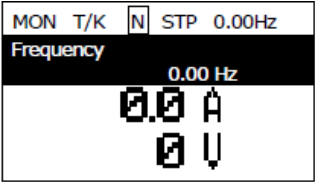
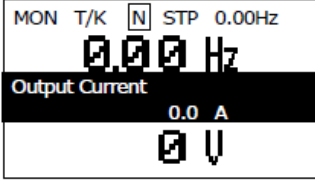
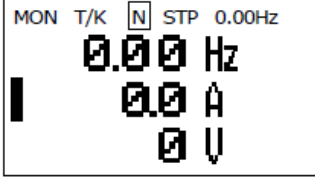
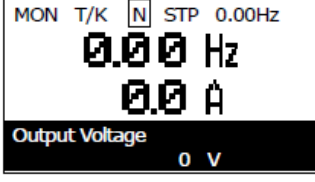
	<ul style="list-style-type: none"> • Displays when the inverter is powered on. This display is in Monitor mode. • The cursor is located at the frequency item. • Press the [Down] key.
	<ul style="list-style-type: none"> • The second display item displays the output current. • Do not press any key for approximately 2 seconds after navigation.
	<ul style="list-style-type: none"> • The output current text has disappeared and the cursor has moved to the second display item. • Press the [Down] key.
	<ul style="list-style-type: none"> • The third display item displays the output voltage. • Do not press any key for approximately 2 seconds after navigation.

	<ul style="list-style-type: none"> • The output voltage text has disappeared and the cursor has moved to the third display item. • Press the [Up] key twice.
	<ul style="list-style-type: none"> • The first item displays the frequency.
	<ul style="list-style-type: none"> • The frequency text has disappeared and the cursor has moved to the first display item.

6.5.2 Code Navigation (function items) in Other Modes and Groups

Using the [Up] and [Down] keys: The following example demonstrates how to navigate through the codes in the Drive (DRV) group and the Basic [BAS] group of Parameter mode. Code navigation in other modes is the same as follows.

	<ul style="list-style-type: none"> • Displays when the inverter is powered on. This display is in Monitor mode. • Press the [Down] key.
--	---

<pre> PAR →DRV [N] STP 0.00Hz 00 Jump Code 1 CODE 01 Cmd Frequency 0.00 Hz 02 Acc Time 20.0 sec </pre>	<ul style="list-style-type: none"> Displays the Drive (DRV) group of Parameter mode. If the DRV group is not displayed, press the [MODE] key until the DRV group appears, or press the [ESC] key.
<pre> PAR →DRV [N] STP 0.00Hz 00 Jump Code 9 CODE 01 Cmd Frequency 0.00 Hz 02 Acc Time 20.0 sec </pre>	<ul style="list-style-type: none"> If you press the [Down] key, you will navigate to code No. 01 in the DRV group of Parameter mode. Press the [Right] key.
<pre> PAR →BAS [N] STP 0.00Hz 00 Jump Code 20 CODE 01 Aux Ref Src None 04 Cmd 2nd Src Fx/Rx-1 </pre>	<ul style="list-style-type: none"> You have moved to the Basic (BAS) group of Parameter mode. You can navigate through the codes using the [Up] or [Down] keys.

6.5.3 Code Navigation Using Jump Code

In the Parameter mode and User/Macro mode groups, you can use the Jump Code Entry item to move to a desired code. It is quicker to move to a large code number using the Jump Code Entry item rather than the [Up] and [Down] keys. The following example demonstrates how to move to code No. 09 of the Drive (DRV) group.

<pre> PAR →DRV [N] STP 0.00Hz 00 Jump Code 9 CODE 01 Cmd Frequency 0.00 Hz 02 Acc Time 20.0 sec </pre>	<ul style="list-style-type: none"> Ensure that code No. 00 is displayed in the initial display of the Drive (DRV) group of Parameter mode. Press the [PROG/ENT] key.
--	--

Using the Keypad

<pre> PAR →DRV [N] STP 0.00Hz 00 Jump Code 9 CODE 01 Cmd Frequency 0.00 Hz 02 Acc Time 20.0sec </pre>	<ul style="list-style-type: none"> The cursor flashes and you can enter the code number.
<pre> PAR →DRV [N] STP 0.00Hz 00 Jump Code 9 CODE 1~99 CODE D:9 C:9 </pre>	<ul style="list-style-type: none"> Press the [Up] key to enter 9 and then press the [PROG/ENT] key.
<pre> PAR →DRV [N] STP 0.00Hz 09 Control Mode V/F 10 Torque Control No 11 JOG Frequency 10.00 Hz </pre>	<ul style="list-style-type: none"> You have moved to code No. 09 of the DRV group.
<pre> PAR →DRV [N] STP 0.00Hz 00 Jump Code 9 CODE 01 Cmd Frequency 0.00 Hz 02 Acc Time 20.0sec </pre>	<ul style="list-style-type: none"> Press the [ESC] key to move to code No. 00 of the DRV group.

6.6 Setting Parameters

6.6.1 Parameter Settings in Monitor Mode

You can set some parameters, such as the frequency, in Monitor mode. The following example demonstrates how to set the frequency.

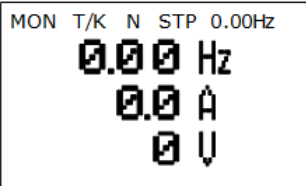
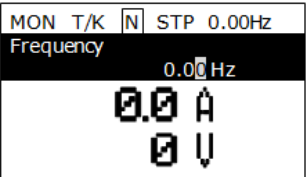
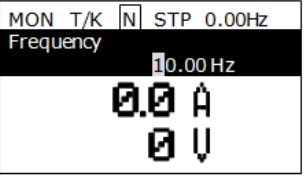
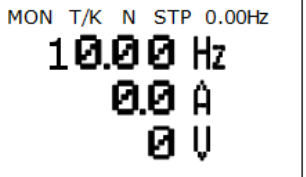
	<ul style="list-style-type: none"> • Ensure that the cursor is at the frequency item. Also, ensure that the frequency can be set to 09 in the Drive (DRV) group using the keypad. • Press the [PROG/ENT] key.
	<ul style="list-style-type: none"> • Detailed information of the item is displayed and the cursor flashes. • Press the [Left] or [Right] keys to move the cursor to the desired location to set the frequency.
	<ul style="list-style-type: none"> • Press the [Up] key to set the frequency to 10 Hz. • Press the [PROG/ENT] key.
	<ul style="list-style-type: none"> • The frequency reference is set to 10 Hz.

6.6.2 Parameter Settings in Other Modes and Groups

The following example demonstrates how to change the frequency of the Drive (DRV) group in Parameter mode. The frequency in the other modes or groups can be set as follows.

<pre> PAR →DRV [N] STP 0.00Hz 00 JumpCode 9 CODE 01 Cmd Frequency 0.00 Hz 02 Cmd Torque 0.0 % </pre>	<ul style="list-style-type: none"> • This is the initial display in Parameter mode. • Press the [Down] key.
<pre> PAR →DRV [N] STP 0.00Hz 00 JumpCode 9 CODE 01 Cmd Frequency 0.00 Hz 02 Cmd Torque 0.0 % </pre>	<ul style="list-style-type: none"> • You have moved to the 01 frequency setting code. • Press the [PROG/ENT] key.
<pre> PAR →DRV [N] STP 0.00Hz 01 Cmd Frequency 0.00 Hz 0.50 ~ 60.00 Hz D:0.00 C:0.00 </pre>	<ul style="list-style-type: none"> • The cursor flashes and you can enter the desired frequency. • If the frequency reference is set to 10 Hz, press the [Left] or [Right] keys to move the cursor to the desired place.
<pre> PAR →DRV [N] STP 0.00Hz 01 Cmd Frequency 10.00 Hz 0.50 ~ 60.00 Hz D:0.00 C:0.00 </pre>	<ul style="list-style-type: none"> • Press the [Up] key to enter 10 Hz and then press the [PROG/ENT] key.
<pre> PAR →DRV [N] STP 0.00Hz 00 JumpCode 9 CODE 01 Cmd Frequency 10.00 Hz 02 Cmd Torque 0.0 % </pre>	<ul style="list-style-type: none"> • The frequency reference is set to 10 Hz.

6.7 Monitoring Operating Status

6.7.1 Using Monitor Mode

Three items can be displayed in Monitor mode at a time. Also, some items, such as the frequency item, can be edited. You can select the displayed items in Configuration (CNF) mode.

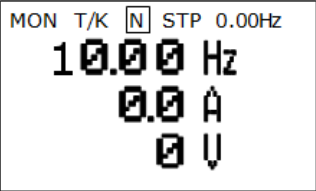
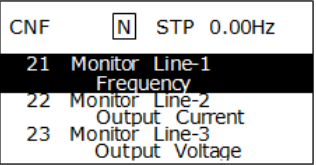
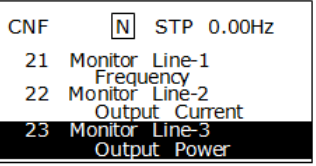
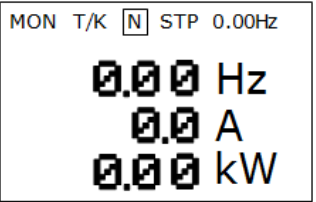
 <p>MON T/K [N] STP 0.00Hz 10.00 Hz 0.0 A 0 V</p>	<ul style="list-style-type: none"> This is the initial display in Monitor mode. The frequency, current, and voltage are set as the default monitor items. The frequency reference is displayed when the inverter operation has stopped, and the operating frequency is displayed when the inverter is operating.
 <p>CNF [N] STP 0.00Hz 21 Monitor Line-1 Frequency 22 Monitor Line-2 Output Current 23 Monitor Line-3 Output Voltage</p>	<ul style="list-style-type: none"> You can set the items to display in Monitor mode in sequence from 21 to 23 in Configuration (CNF) mode. Press the [Down] key to move to code No. 23
 <p>CNF [N] STP 0.00Hz 21 Monitor Line-1 Frequency 22 Monitor Line-2 Output Current 23 Monitor Line-3 Output Power</p>	<ul style="list-style-type: none"> Change the code No. 23 item in Monitor mode to the output power.
 <p>MON T/K [N] STP 0.00Hz 0.00 Hz 0.0 A 0.00 kW</p>	<ul style="list-style-type: none"> Ensure that the third displayed item in Monitor mode is changed to the output power.

6.7.2 Monitoring Items

Mode	Code	Function Display	Setting Range		Initial Value
CNF	20	Anytime Para	0	Frequency	0: Frequency
	21	Monitor Line-1	1	Speed	0: Frequency
	22	Monitor Line-2	2	Output Current	2:Output Current
	23	Monitor Line-3	3	Output Voltage	3:Output Voltage
			4	Output Power	
			5	WHour Counter	
			6	DCLink Voltage	
			7	DI Status	
			8	DO Status	
			9	V1 Monitor [V]	
			10	V1 Monitor [%]	
			11	I1 Monitor [mA]	
			12	I1 Monitor [%]	
			13	V2 Monitor [V]	
			14	V2 Monitor [%]	
			15	I2 Monitor [mA]	
			16	I2 Monitor [%]	
			17	PID Output	
			18	PID Ref Value	
			19	PID Fdb Value	
			20	Torque	
			21	Torque Limit	
			22	Trq Bias Ref	
			23	Speed Limit	
			24	Load Speed	
25			Temperature		

6.7.3 Using the Status Display

The items displayed on the right-top of the display are shown in other modes, including Monitor mode. If you register a desired variable in the display, you can monitor it at any time regardless of the mode navigation or change.

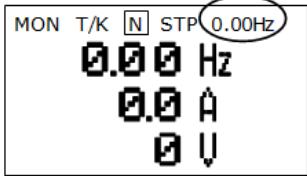
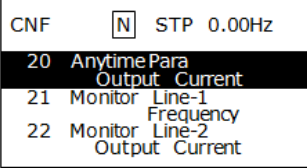
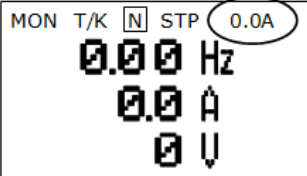
 <p>MON T/K [N] STP 0.00Hz 0.00 Hz 0.0 A 0 V</p>	<ul style="list-style-type: none"> • This is the initial display of Monitor mode. • When the inverter settings are set to the factory default, the status item displays the frequency.
 <p>CNF [N] STP 0.00Hz 20 Anytime Para Output Current 21 Monitor Line-1 Frequency 22 Monitor Line-2 Output Current</p>	<ul style="list-style-type: none"> • Select the item to display in the status display in code 20 of Configuration (CNF) mode. • Press the [PROG/ENT] key to change the item to the output current. • The unit at the top of the display is changed from hertz (frequency) to amps (current).
 <p>MON T/K [N] STP 0.0A 0.00 Hz 0.0 A 0 V</p>	<ul style="list-style-type: none"> • Ensure that the unit in the status display is changed to amps (current) in Monitor mode.

6.8 Monitoring Faults

6.8.1 Faults during Inverter Operation

<pre> TRP current OverVoltage (01) 01 Output Freq 48.30 Hz 02 Output Current 33.3 A </pre>	<ul style="list-style-type: none"> If a fault trip occurs during inverter operation, the inverter enters Trip mode automatically and displays the type of fault trip that has occurred.
<pre> TRP Last-1 01 Output Freq 48.30 Hz 02 Output Current 33.3 A 03 Inverter State Stop </pre>	<ul style="list-style-type: none"> Press the [Down] key to view the information on the inverter at the time of the fault, including the output frequency, current, and operating status.
<pre> MON T/K N STP 0.0A 0.00 Hz 0.0 A 0 V </pre>	<ul style="list-style-type: none"> When the inverter is reset and the fault trip is released, the keypad display returns to the screen that was displayed before the fault trip occurred.

6.8.2 Multiple Faults at a Time during Inverter Operation

<pre>TRP current Over Voltage (02) 01 Output Freq 48.30 Hz 02 Output Current 33.3 A</pre>	<ul style="list-style-type: none"> • If multiple fault trips occur at the same time, the number of fault trips that occurred is displayed next to the fault trip type. • Press the [PROG/ENT] key.
<pre>TRP current 00 Trip Name (2) 0 Over Voltage 1 Externa Trip</pre>	<ul style="list-style-type: none"> • The types of all the fault trips are displayed. • Press the [PROG/ENT] key.
<pre>TRP current Over Voltage (02) 01 Output Freq 48.30 Hz 02 Output Current 33.3 A</pre>	<ul style="list-style-type: none"> • The display mode that was shown before you checked the fault information is displayed.

6.8.3 Saving and Monitoring the Fault Trip History

Previous fault trips can be saved in Trip mode. You can save up to 5 previous fault trips. Fault trips caused by resetting the inverter, as well as low voltage faults caused by the inverter being switched off, are also saved.

If there are more than 5 fault trips, the oldest 5 fault trips are automatically deleted.

<pre>TRP current Over Voltage (02) 01 Output Freq 48.30 Hz 02 Output Current 33.3 A</pre>	<ul style="list-style-type: none"> If a fault trip occurs during inverter operation, the inverter enters Trip mode and displays the type of fault trip that has occurred.
<pre>MON T/K [N] STP 0.0A 0.00 Hz 0.0 A 0 V</pre>	<ul style="list-style-type: none"> If you press the [STOP/RESET] key or an input is entered on the terminal, the fault trip is automatically saved and the display status that was displayed before the fault trip occurred is displayed. Press the [MODE] key to move to Trip mode.
<pre>TRP current 00 Trip Name (2) Over Voltage 01 Output Freq 48.30 Hz 02 Output Current 33.3 A</pre>	<ul style="list-style-type: none"> The most recent fault trip is saved in the Last-1 code. Press the [Right] key.
<pre>TRP current 00 Trip Name (1) External Trip 01 Output Freq 48.30 Hz 02 Output Current 33.3 A</pre>	<ul style="list-style-type: none"> The previous fault trips are saved in the Last-2 code. If another fault trip occurs, the previous fault trips saved in the Last-2 code move to the Last-3 code.

6.9 Initializing Parameters

You can initialize the changed parameters. In addition to initializing the entire parameter, you can also select the individual parameter mode to be initialized.

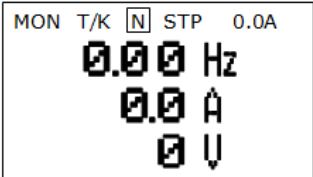
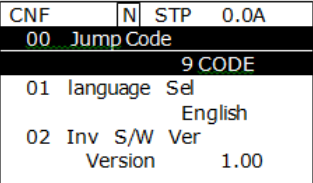
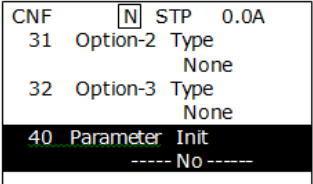
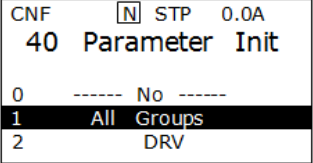
	<ul style="list-style-type: none"> • Monitor mode is displayed.
	<ul style="list-style-type: none"> • Press the [MODE] key to move to Configuration (CNF) mode.
	<ul style="list-style-type: none"> • Press the [Down] key to move to code No. 40. • Press the [PROG/ENT] key.
	<ul style="list-style-type: none"> • Of the parameter items to initialize, select All Groups and then press the [PROG/ENT] key.

```
CNF      [N] STP  0.0A
31 Option-2 Type
           None
32 Option-3 Type
           None
40 Parameter Init
           ----- No -----
```

- The Parameter Initialization option is displayed again when the initialization is complete.

7 Basic Functions

7.1 Setting Frequency References

The iS7 inverter provides several methods to set up and modify a frequency reference for an operation. The keypad, analog inputs [for example voltage (V1) and current (I1) signals], or RS-485 (digital signals from higher-level controllers, such as PCs or PLCs) can be used.

Group	Code	Name	LCD Display	Parameter Setting		Setting Range	Unit
DRV	07	Frequency reference source	Freq Ref Src	0	KeyPad-1	0-9	-
				1	KeyPad-2		
				2	V1		
				3	I1		
				4	V2		
				5	I2		
				6	Int 485		
				7	Encoder		
				8	Field Bus		
				9	Pulse		

7.1.1 Keypad as the Source (KeyPad-1 setting)

You can modify the frequency reference using the keypad and apply changes by pressing the [ENT/PROG] key. To use the keypad as a frequency reference input source, go to DRV-07 (Frequency reference source) and change the parameter value to "0 (Keypad-1)". Input the frequency reference for an operation at DRV-01 (Frequency reference).

Group	Code	Name	LCD Display	Parameter Setting		Setting Range	Unit
DRV	01	Frequency reference	Cmd Frequency	0.00		0.00–max. frequency*	Hz
	07	Frequency reference source	Freq Ref Src	0	KeyPad-1	0–9	-

* You cannot set a frequency reference that exceeds the max. frequency, as configured with DRV-20.

7.1.2 Keypad as the Source (KeyPad-2 setting)

You can use the [UP] and [DOWN] cursor keys to modify a frequency reference. To use this as a second option, set the keypad as the source of the frequency reference by going to DRV-07 (Frequency reference source) and changing the parameter value to "1 (Keypad-2)". This allows frequency reference values to be increased or decreased by pressing the [UP] and [DOWN] cursor keys.

Group	Code	Name	LCD Display	Parameter Setting		Setting Range	Unit
DRV	01	Frequency reference	Cmd Frequency	0.00		0.00–max. frequency *	Hz
	07	Frequency reference source	Freq Ref Src	1	KeyPad-2	0–9	-

* You cannot set a frequency reference that exceeds the max. frequency, as configured with DRV-20.

7.1.3 V1 Terminal as the Source

You can set and modify a frequency reference by setting voltage inputs when using the V1 terminal. Use voltage inputs ranging from 0–10 V (unipolar) for forward-only operations. Use voltage inputs ranging from -10 to +10 V (bipolar) for both directions, with negative voltage inputs used for reverse operations.

7.1.3.1 Setting a Frequency Reference for 0–10 V Input

Set IN-06 (V1 Polarity) to “0 (unipolar)”. Use a voltage output from an external source or use the voltage output from the VR terminal to provide inputs to V1. Refer to the diagrams below for the wiring required for each application.

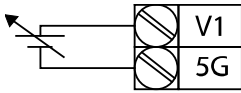

[External source application]

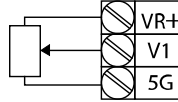

[Internal source (VR) application]

Group	Code	Name	LCD Display	Parameter Setting		Setting Range	Unit
DRV	07	Frequency reference source	Freq Ref Src	2	V1	0–9	-
IN	01	Frequency at maximum analog input	Freq at 100%	Maximum frequency		0.00–max. frequency	Hz
	05	V1 input monitor	V1 Monitor[V]	0.00		0.00–10.00	V
	06	V1 polarity options	V1 Polarity	0	Unipolar	0–1	-
	07	V1 input filter time constant	V1 Filter	10		0–10000	ms
	08	V1 minimum input voltage	V1 volt x1	0.00		0.00–10.00	V
	09	V1 output at minimum voltage (%)	V1 Perc y1	0.00		0.00–100.00	%
	10	V1 maximum input voltage	V1 Volt x2	10.00		0.00– 10.00	V
	11	V1 output at maximum voltage (%)	V1 Perc y2	100.00		0–100	%
	16	Rotation direction options	V1 Inverting	0	No	0–1	-
	17	V1 quantizing level	V1 Quantizing	0.04		0.00*, 0.04–10.00	%

*Quantizing is disabled if “0” is selected.

0–10 V Input Voltage Setting Details

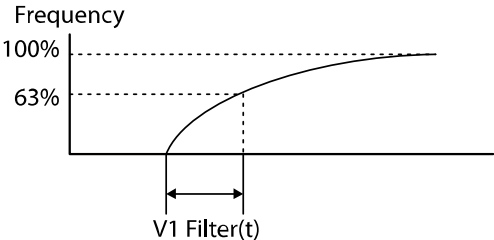
Code	Description
IN-01 Freq at 100%	<p>Configures the frequency reference at the maximum input voltage when a potentiometer is connected to the control terminal block. A frequency set with code IN-01 becomes the maximum frequency only if the value set in code IN-11 (or IN-15) is 100%.</p> <ul style="list-style-type: none"> Set code IN-01 to 40.00 and use default values for codes IN-02–IN-16. The motor will run at 40.00 Hz when a 10 V input is provided at V1. Set code IN-11 to 50.00 and use default values for codes IN-01–IN-16. The motor will run at 30.00 Hz (50% of the default maximum frequency–60 Hz) when a 10 V input is provided at V1.
IN-05 V1 Monitor[V]	<p>Configures the inverter to monitor the input voltage at V1.</p>
IN-07 V1 Filter	<p>The V1 filter may be used when there are large variations between reference frequencies. Variations can be mitigated by increasing the time constant, but this requires an increased response time.</p> <p>The value t (time) indicates the time required for the frequency to reach 63% of the reference, when external input voltages are provided in multiple steps.</p> <div style="text-align: center;"> <p>V1 input from external source </p>  <p>[V1 Filter]</p> </div>
IN-08 V1 volt x1– IN-11 V1 Perc y2	<p>These parameters are used to configure the gradient level and offset values of the output frequency, based on the input voltage.</p>

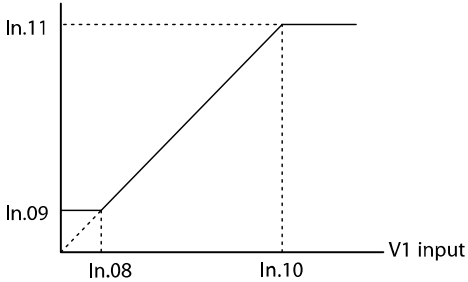
Code	Description
	<p>Frequency reference</p> 
IN-16 V1 Inverting	<p>Inverts the direction of rotation. Set this code to "1 (Yes)" if you need the motor to run in the opposite direction from the current rotation.</p>
IN-17 V1 Quantizing	<p>Quantizing may be used when the noise level is high in the analog input (V1 terminal) signal. Quantizing is useful when you are operating a noise-sensitive system, because it suppresses any signal noise. However, quantizing will diminish system sensitivity (resultant power of the output frequency will decrease based on the analog input). You can also turn on the low-pass filter using code IN-07 to reduce the noise, but increasing the value will reduce responsiveness and may cause pulsations (ripples) in the output frequency.</p> <p>Parameter values for quantizing refer to a percentage based on the maximum input. Therefore, if the value is set to 1% of the maximum analog input (60 Hz), the output frequency will increase or decrease by 0.6 Hz for every 0.1 V change in voltage.</p> <p>When the analog input is increased, an increase in the input equal to 75% of the set value will change the output frequency, and then the frequency will increase according to the set value. Likewise, when the analog input decreases, a decrease in the input equal to 75% of the set value will make an initial change to the output frequency.</p> <p>As a result, the output frequency will be different at acceleration and deceleration, mitigating the effect of analog input changes over the output frequency (ripples).</p>

Basic Functions

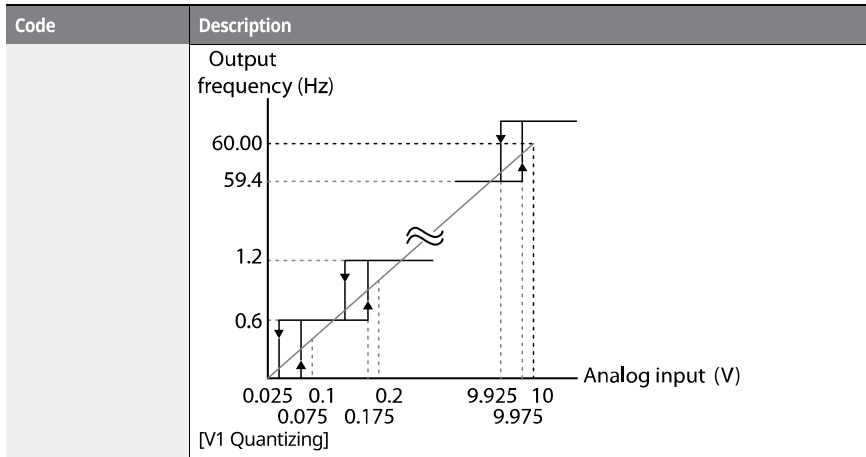

7.1.3.2 Setting a Frequency Reference for -10~+10 V Input

Set DRV-07 (Frequency reference source) to "2 (V1)", and then set IN-06 (V1 Polarity) to "1 (bipolar)". Use the output voltage from an external source to provide an input to V1.

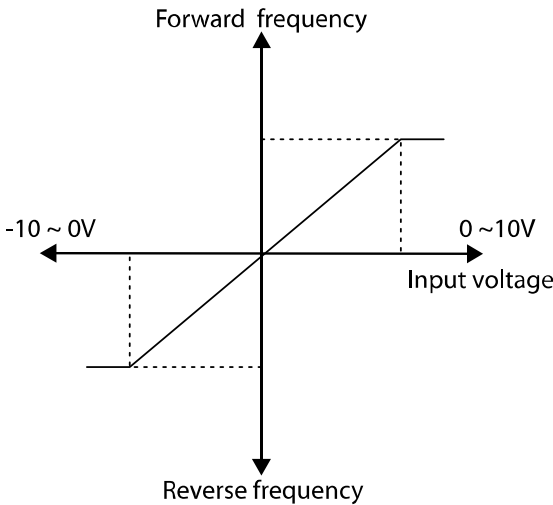
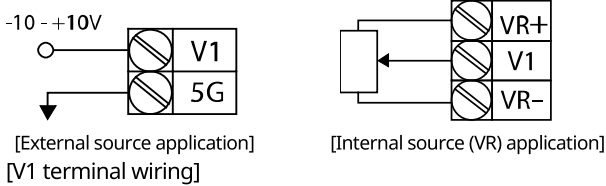

[Bipolar input voltage and output frequency]

Group	Code	Name	LCD Display	Parameter Setting	Setting Range	Unit
DRV	07	Frequency reference source	Freq Ref Src	2 V1	0-9	-
IN	01	Frequency at maximum analog input	Freq at 100%	60.00	0-max. frequency	Hz

Basic Functions

Group	Code	Name	LCD Display	Parameter Setting	Setting Range	Unit
	05	V1 input monitor	V1 Monitor	0.00	0.00–10.00 V	V
	06	V1 polarity options	V1 Polarity	1 Bipolar	0–1	-
	12	V1 minimum input voltage	V1- volt x1	0.00	0.00–10.00 V	V
	13	V1 output at minimum voltage (%)	V1- Perc y1	0.00	-100.00–0.00%	%
	14	V1 maximum input voltage	V1- Volt x2	-10.00	-10.00–0.00 V	V
	15	V1 output at maximum voltage (%)	V1- Perc y2	-100.00	-100.00–0.00%	%

Rotational Directions for Different Voltage Inputs

Command / Voltage Input	Input voltage	
	0–10 V	-10–0 V
FWD	Forward	Reverse
REV	Reverse	Forward

10–10 V Voltage Input Setting Details

Code	Description
IN-12 V1- volt x1– IN-15 V1- Perc y2	<p>Sets the gradient level and offset value of the output frequency in relation to the input voltage. These codes are displayed only when IN-06 is set to “1 (bipolar)”.</p> <p>As an example, if the minimum input voltage (at V1) is set to “-2 (V)” with 10% output ratio, and the maximum voltage is set to “-8 (V)” with an 80% output ratio, the output frequency will vary within the range of 6–48 Hz.</p>

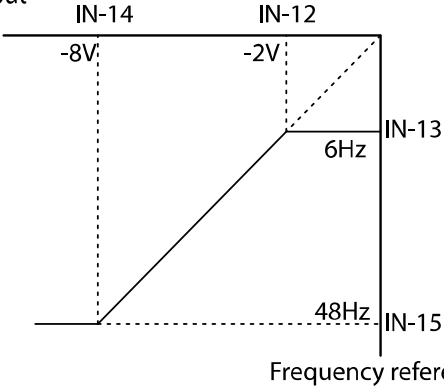
Code	Description
	<p>V1 input</p>  <p>For details about the 0→+10 V analog inputs, refer to the code descriptions IN-08 V1 volt x1-IN-11 V1 Perc y2 on page 143</p>

7.1.3.3 Setting a Reference Frequency using Input Current (I1)

You can set and modify a frequency reference using input current at the I1 terminal. Set DRV-07 (Frequency reference source) to "3 (I1)" and apply an input current of 0–20 mA to I1.

Group	Code	Name	LCD Display	Parameter Setting		Setting Range	Unit
DRV	07	Frequency reference source	Freq Ref Src	3	I1	0–9	-
IN	01	Frequency at maximum analog input	Freq at 100%	60.00		0–max. frequency	Hz
	20	I1 input monitor	I1 Monitor	0.00		0.00–20.00	mA
	22	I1 input filter time constant	I1 Filter	10		0–10000	ms
	23	I1 minimum input current	I1 Curr x1	4.00		0.00–20.00	mA
	24	I1 output at minimum current (%)	I1 Perc y1	0.00		0–100	%
	25	I1 maximum input current	I1 Curr x2	20.00		4.00–20.00	mA
	26	I1 output at maximum current (%)	I1 Perc y2	100.00		0.00–100.00	%
	31	I1 rotation direction options	I1 Inverting	0	No	0–1	-
	32	I1 quantizing level	I1 Quantizing	0.04		0.00*, 0.04–10.00	%

*Quantizing is disabled if "0" is selected.

Input Current (I1) Setting Details

Code	Description
IN-01 Freq at 100%	<p>Configures the frequency reference for operation at the maximum current (when IN-26 is set to 100%).</p> <ul style="list-style-type: none"> If IN-01 is set to 40.00, and default settings are used for IN-23–26, an input current of 20 mA (max) to I1 will produce a frequency reference of 40.00 Hz. If IN-26 is set to 50.00, and default settings are used for IN-01 (60 Hz) and IN-23–26, an input current of 20 mA (max) to I1 will produce a frequency reference of 30.00 Hz (50% of 60 Hz).
IN-20 I1 Monitor	Used to monitor the input current at I1.
IN-22 I1 Filter	Configures the time for the operation frequency to reach 63% of the target frequency based on the input current at I1.
IN-23 I1 Curr x1– IN-26 I1 Perc y2	<p>Configures the gradient level and offset value of the output frequency.</p> <p>[Gradient and offset configuration based on output frequency]</p>
IN-32 I1 Quantizing	Same as V1 Quantizing. For more details, refer to 7.1.3.1 Setting a Frequency Reference for 0–10 V Input on page 139.

7.1.4 Setting a Frequency Reference Using an I/O Expansion Module (Terminal V2/I2)

After installing an optional I/O expansion module to the iS7 inverter, you can set and modify a frequency reference using the input voltage or current at the V2/I2 terminal.

7.1.4.1 Setting a Reference Frequency using Input Voltage at V2 Terminal

Set the DRV-07 (Frequency reference source) to “4 (V2)” and apply an input voltage of -10~+12 V to the V2 terminal.

Group	Code	Name	LCD Display	Parameter Setting		Setting Range	Unit
DRV	07	Frequency reference source	Freq Ref Src	4	V2	0-9	-
IN	35	V2 input display	V2 Monitor	0.00		-10.00~+10.00	V
	37	V2 input filter time constant	V2 Filter	10		0-10000	ms
	38	Minimum V2 input voltage	V2 Volt x1	0.00		0.00-10.00	V
	39	Output% at minimum V2 voltage	V2 Perc y1	0.00		0.00-100.00	%
	40	Maximum V2 input voltage	V2 Volt x2	10.00		0.00-10.00	V
	41	Output% at maximum V2 voltage	V2 Perc y2	100.00		0.00-100.00	%
	42	Minimum V2 input voltage'	V2 -Volt x1'	0.00		0-10	V
	43	Output% at minimum V2 voltage'	V2 -Perc y1'	0.00		0-100	%
	44	Maximum V2 input voltage'	V2 -Volt x2'	-10.00		0-10	V
	45	Output% at	V2 -Perc y2'	-100.00		-100-0	%

Group	Code	Name	LCD Display	Parameter Setting	Setting Range	Unit
		maximum V2' voltage				
	46	Invert V2 rotational direction	V2 Inverting	No	No/Yes	-
	47	V2 quantizing level	V2 Quantizing	0.04	0.00*, 0.04–10.00	%

*Quantizing is disabled if "0" is selected.

7.1.4.2 Setting a Reference Frequency using Input Current at I2 Terminal

Set the DRV-07 (Frequency reference source) to "5 (I2)" and apply an input voltage of 0–20 mA to the I2 terminal.

Group	Code	Name	LCD Display	Parameter Setting	Setting Range	Unit
DRV	07	Frequency reference source	Freq Ref Src	5 I2	0–9	-
	50	I2 input monitor	I2 Monitor	0.00	0.00–20.00	mA
	52	I2 input filter time constant	I2 Filter	10	0–10000	ms
	53	I2 minimum input current	I2 Curr x1	4.00	0.00–20.00	mA
	54	I2 output at minimum current (%)	I2 Perc y1	0.00	0–100	%
	55	I2 maximum input current	I2 Curr x2	20.00	4.00–20.00	mA
	56	I2 output at maximum current (%)	I2 Perc y2	100.00	0.00–100.00	%
	61	I2 rotation direction options	I2 Inverting	0 No	0–1	-
	62	I2 quantizing level	I2 Quantizing	0.04	0.00*, 0.04–10.00	%

*Quantizing is disabled if "0" is selected.

7.1.5 Setting a Frequency with Pulse Input (with an optional encoder module)

After installing an optional encoder module, you can set a frequency reference by setting DRV-07 (Frequency reference source) to "9 (Pulse)" and providing a pulse frequency of 0–32.00 kHz to the pulse input terminal.

Group	Code	Name	LCD Display	Parameter Setting		Setting Range	Unit
DRV	07	Frequency reference source	Freq Ref Src	7	Encoder	0-9	-
IN	01	Frequency at maximum analog input	Freq at 100%	60.00		0.00-max. frequency	Hz
APO	01	Encoder option mode	Enc Opt Mode	2	Reference	0-2	-
	04	Encoder type selection	Enc Type Sel	0	-	0-2	-
	05	Encoder pulse selection	Enc Pulse Sel	2	A	0-2	-
	06	Encoder pulse number	Enc Pulse Num	-		10-5000	-
	09	Pulse input display	Pulse Monitor	-		-	kHz
	10	Encoder filter time constant	Enc Filter	10		0-10000	ms
	93	Minimum pulse input	Enc Pulse x1	0.0		0-100	kHz
	94	Minimum pulse Output%	Enc Perc Y1	0.00		0-100	%
	95	Maximum pulse input	Enc Pulse x2	100.0		0-200	kHz
	96	Maximum pulse Output%	Enc Perc y2	100.00		0-100	%

* Quantizing is disabled if "0" is selected.

Pulse Input Setting Details

Code	Description
APO-01 Enc Opt Mode	Sets the encoder option mode. Set APO-01 to "2 (Reference)" to receive a pulse input for the frequency reference.
APO-04 Enc Type Sel	Sets the output type.
APO-05 Enc Pulse Sel	Selects the encoder pulse to use.
APO-06 Enc Pulse Num	Sets the number of pulses that is appropriate for the encoder specification.
APO-09 Pulse Monitor	Displays the pulse frequency supplied at the encoder option module when APO-1 is set to "2 (Reference)".
APO-10 Enc Filter	Sets the time for the pulse input to reach 63% of its nominal frequency (when the pulse frequency is supplied in multiple steps).
APO-11 Enc Pulse x1-IN-96 Enc Perc y2	<p>Configures the gradient level and offset values for the output frequency.</p> <p>Frequency reference</p>

7.1.6 Setting a Frequency Reference via RS-485 Communication

Control the inverter with upper-level controllers, such as PCs or PLCs, via RS-485 communication. Set DRV-07 (Frequency reference source) to “6 (Int 485)” and use the RS-485 signal input terminals (S+/S-/SG) for communication. For more details, refer to [11 Communication Function](#) on page 351.

Group	Code	Name	LCD Display	Parameter Setting		Setting Range	Unit
DRV	07	Frequency reference source	Freq Ref Src	6	Int 485	0-9	-
COM	01	Integrated RS-485 communication inverter ID	Int485 St ID	-	1	1-250	-
	02	Integrated communication protocol	Int485 Proto	0	ModBus RTU	0-2	-
				1	ModBus ASCII		
				2	LS Inv 485		
	04	Integrated communication speed	Int485 BaudR	3	9600 bps	1200-38400	bps
	04	Integrated communication frame configuration	Int485 Mode	0	D8/PN/S1	0-3	-
				1	D8/PN/S2		
2				D8/PE/S1			
3				D8/PO/S1			

7.2 Frequency Hold by Analog Input

If you set a frequency reference via the analog input at the control terminal block, you can hold the operation frequency of the inverter by assigning a multi-function input as the analog frequency hold terminal. The operation frequency will be linked to the analog input signal.

Group	Code	Name	LCD Display	Parameter Setting	Setting Range	Unit	
DRV	07	Frequency reference source	Freq Ref Src	0	Keypad-1	0-9	-
				1	Keypad-2		
				2	V1		
				3	I1		
				4	V2		
				5	I2		
				6	Int 485		
				7	Encoder		
				8	Field Bus		
			9	PLC			
IN	65-75	Px terminal configuration	Px Define(Px: P1-P8 [optional: P9-P11]) [Optional P9-11]	21	Analog Hold	65-75	-

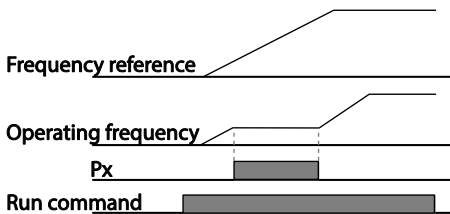

7.3 Changing the Displayed Units (Hz↔Rpm)

You can change the units used to display the operational speed of the inverter by setting DRV-21 (Speed unit selection) to “0 (Hz Display)” or “1 (Rpm Display)”.

Group	Code	Name	LCD Display	Parameter Setting		Setting Range	Unit
DRV	21	Speed unit selection	Hz/Rpm Sel	0	Hz Display	0-1	-
				1	Rpm Display		

7.4 Setting Multi-Step Frequency

Multi-step operations can be carried out by assigning different speeds (or frequencies) to the Px terminals. Step 0 uses the frequency reference source set at DRV-07. Px terminal parameter values 7 (Speed-L), 8 (Speed-M), 9 (Speed-H), and 10 (Speed-X) are recognized as binary commands and work in combination with Fx or Rx run commands. The inverter operates according to the frequencies set at BAS-50-64 (multi-step frequency 1-15) and the binary command combinations.

Group	Code	Name	LCD Display	Parameter Setting		Setting Range	Unit
DRV	07	Frequency reference source	Freq Ref Src	-		-	-
BAS	50-64	Multi-step frequency 1-15	Step Freq - x	-		-	Hz
IN	65-75	Px terminal configuration	Px Define (Px: P1-P8 [optional: P9-P11]) [Optional P9-P11]	7	Speed-L	0-51	-
				8	Speed-M		-
				9	Speed-H		-
				10	Speed-X		-
	89	Multi-step command delay time	InCheck Time	1		1-5000	ms

Multi-step Frequency Setting Details

Code	Description
BAS Group 50-64	Configure multi-step frequency 1-15.

Choose the terminals to set up as multi-step inputs, and then set the relevant codes (IN-65-75) to 7 (Speed-L), 8 (Speed-M), 9 (Speed-H), or 10 (Speed-X). Provided that terminals P6, P7, and P8 have been set to Speed-L, Speed-M and Speed-H respectively, the following multi-step operation will be available.

IN-65-75 Px Define

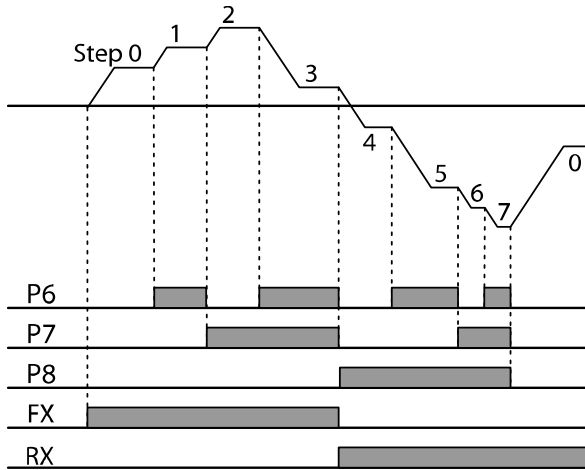

[An example of a multi-step operation]

Speed	Fx/Rx	P8	P7	P6
0	✓	-	-	-
1	✓	-	-	✓
2	✓	-	✓	-
3	✓	-	✓	✓
4	✓	✓	-	-
5	✓	✓	-	✓
6	✓	✓	✓	-
7	✓	✓	✓	✓

By setting the Speed-X, you can configure up to 16 multi-step speeds, where

Code	Description					
	the highest bit is Speed-X.					
	Speed	Fx/Rx	P8	P7	P6	P5
	0	✓	-	-	-	-
	1	✓	-	-	-	✓
	2	✓	-	-	✓	-
	3	✓	-	-	✓	✓
	4	✓	-	✓	-	-
	5	✓	-	✓	-	✓
	6	✓	-	✓	✓	-
	7	✓	-	✓	✓	✓
	8	✓	✓	-	-	-
	9	✓	✓	-	-	✓
	10	✓	✓	-	✓	-
	11	✓	✓	-	✓	✓
	12	✓	✓	✓	-	-
	13	✓	✓	✓	-	✓
	14	✓	✓	✓	✓	-
	15	✓	✓	✓	✓	✓
IN-89 InCheck Time	<p>Set a time interval for the inverter to check for additional terminal block inputs after receiving an input signal.</p> <p>After IN-89 is set to 100 ms and an input signal is received at P6, the inverter will search for inputs at other terminals for 100 ms, before proceeding to accelerate or decelerate based on the configuration at P6.</p>					

7.5 Command Source Configuration

Various devices can be selected as command input devices for the iS7 inverter. Input devices available include the keypad, multi-function input terminal, RS-485 communication, and field bus adapter.

Group	Code	Name	LCD Display	Parameter Setting		Setting Range	Unit
DRV	06	Command Source	Cmd Source	0	Keypad	0-5	-
				1	Fx/Rx-1		
				2	Fx/Rx-2		
				3	Int 485		
				4	Field Bus		
				5	PLC		

7.5.1 The Keypad as a Command Input Device

Set DRV-06 to "0 (Keypad)" to select the keypad as the command source.

Since the keypad is now the command source, forward or reverse operation starts when the [FWD] or [REV] key is pressed, and it stops when the [STOP/RESET] key is pressed.

Group	Code	Name	LCD Display	Parameter Setting		Setting Range	Unit
DRV	06	Command source	Cmd Source	0	KeyPad	0-5	-

7.5.2 The Terminal Block as a Command Input Device (Fwd/Rev run commands)

Multi-function terminals can be selected as a command input device. This is configured by setting DRV-06 (command source) to "1 (Fx/Rx-1)". Select two terminals for the forward and reverse operations, and then set the relevant codes (2 of the 11 multi-function terminal codes, IN-65-75 for P1-P8 [optional: P9-P11]) to "1 (Fx)" and "2 (Rx)" respectively. This application enables both terminals to be turned on or off at the same time, constituting a stop command that will cause the inverter to stop operating.

Group	Code	Name	LCD Display	Parameter Setting		Setting Range	Unit
DRV	06	Command source	Cmd Source	1	Fx/Rx-1	0-5	-
IN	65-75	Px terminal configuration	Px Define(Px: P1- P8 [optional: P9-P11])	1	Fx	0-51	-
				2	Rx		
	88	Delay time setting	Run On Delay	-	1.00	0.00-100.00	Sec

Fwd/Rev Command by Multi-function Terminal – Setting Details

Code	Description
DRV-06 Cmd Source	Set to "1 (Fx/Rx-1)".
IN-65-75 Px Define	Assign a terminal for forward (Fx) operation. Assign a terminal for reverse (Rx) operation.
IN-88 Run On Delay	Set the delay time if the inverter operation needs to be synchronized with other sequences. When the run command input (Fx/Rx) is given, the operation begins after the set time has elapsed.

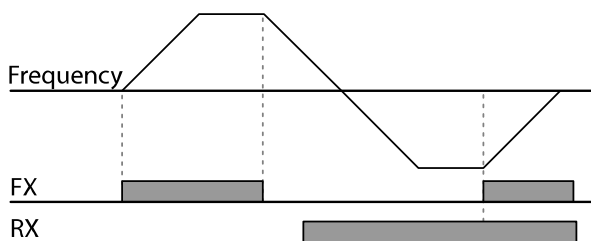

7.5.3 The Terminal Block as a Command Input Device (Run and Rotation Direction Commands)

Multi-function terminals can be selected as a command input device. This is configured by setting DRV-06 (command source) to "2 (Fx/Rx-2)". Select two terminals for run and rotation direction commands, and then set the relevant codes (2 of the 11 multi-function terminal codes, IN-65-75 for P1-P11 [optional: P9-P11]) to "1 (Fx)" and "2 (Rx)" respectively. This application uses an Fx input as a run command, and an Rx input to change a motor's rotation direction (On: Rx, Off: Fx).

Group	Code	Name	LCD Display	Parameter Setting		Setting Range	Unit
DRV	06	Command source	Cmd Source	2	Fx/Rx-2	0-5	-
IN	65-75	Px terminal configuration	Px Define (Px: P1-P8 [optional: P9-P11])	1	Fx	-	-
				2	Rx		
	88	Delay time setting	Run On Delay	-	1.00	0.00-100.00	Sec

Run Command and Fwd/Rev Change Command Using Multi-function Terminal – Setting Details

Code	Description
DRV-06 Cmd Source	Set to "2 (Fx/Rx-2)".
IN-65-75 Px Define	Assign a terminal for the run command (Fx). Assign a terminal for changing the rotation direction (Rx).
IN-88 Run On Delay	Set the delay time if the inverter operation needs to be synchronized with other sequences. When the run command input (Fx/Rx) is given, the operation begins after the set time has elapsed.

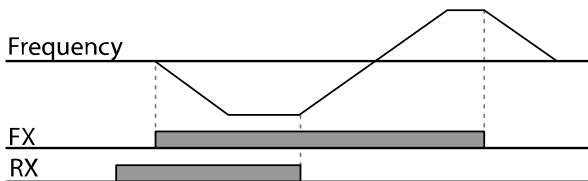

7.5.4 RS-485 Communication as a Command Input Device

Internal RS-485 communication can be selected as a command input device by setting DRV-06 (command source) in the Drive group to "3 (Int 485)". This configuration uses upper level controllers, such as PCs or PLCs, to control the inverter by transmitting and receiving signals via the S+, S-, and RS-485 signal input terminals at the terminal block. For more details, refer to [11 Communication Function](#) on page 351.

Group	Code	Name	LCD Display	Parameter Setting		Setting Range	Unit
DRV	06	Command source	Cmd Source	3	Int 485	0–5	-
COM	04	Integrated communication inverter ID	Int485 St ID	1		1–250	-
	05	Integrated communication protocol	Int485 Proto	0	ModBus RTU	-	-
	06	Integrated communication speed	Int485 BaudR	3	9600 bps	1200–38400	bps
	07	Integrated communication frame setup	Int485 Mode	0	D8 / PN / S1	-	-

7.6 Local/Remote Mode Switching

Local/remote mode switching is useful for checking the inverter's operation, or to perform an inspection while retaining all parameter values. Also, in an emergency, it can also be used to override controls and operate the system manually using the keypad.

The [MULTI] key is a programmable key that can be configured to carry out multiple functions.

⚠ Caution

Use local/remote operation mode switching only when it is necessary. Improper mode switching may interrupt the inverter's operation.

Group	Code	Name	LCD Display	Parameter Setting	Setting Range	Unit
CNF	42	[MULTI] key functions	Multi-Key Sel	2 Local/Remote	-	-
DRV	06	Command source	Cmd Source	1 Fx/Rx-1	0-5	-

Local/Remote Mode Switching Setting Details

Code	Description
CNF-42 [MULTI] key functions	<p>Set CNF-42 to "2(Local/Remote)" to perform local/remote mode switching using the [MULTI] key.</p> <p>Once the parameter is set, "R" (remote) is displayed on the keypad, and the inverter will automatically begin operating in remote mode. Changing from local to remote operation will not alter any previously configured parameter values and the operation of the inverter will not change.</p> <p>Press the [MULTI] key to switch the operation mode to "local." "L" (local) is displayed on the keypad, and the command source and frequency source indication on the keypad (in MON mode) changes to "K/K." The inverter stops operating if it was previously running in remote mode, and you can operate the inverter using the keypad.</p> <p>Press the [MULTI] key again to switch the operation mode back to "remote." "R" (remote) is displayed again on the keypad, and the command source and frequency source indication on the keypad (in MON mode) changes according to the previous parameter settings. The inverter is now ready to operate in remote mode, and the inverter operation may vary depending on the type of input source.</p>

Note

Local/Remote Operation

- Full control of the inverter is available with the keypad during local operation.
- During local operation, jog commands will only work if one of the multi-function terminals (Px: P1-P11, codes IN-65-75) is set to "13 (RUN Enable)" and the relevant terminal is turned on.
- During remote operation, the inverter will operate according to the previously set frequency reference source and the command received from the input device.
- If ADV-10 (power-on run) is set to "0 (No)", the inverter will not operate on power-on even when the following terminals are turned on:
 - Fwd/Rev run (Fx/Rx) terminal
 - Fwd/Rev jog terminal (Fwd jog/Rev Jog)

- Pre-excitation terminal

To operate the inverter manually with the keypad, switch to local mode. Use caution when switching back to remote operation mode as the inverter will stop operating. If ADV-10 (power-on run) is set to "0 (No)", a command through the input terminals will work only after all the terminals listed above have been turned off and then turned on again.

- If the inverter has been reset to clear a fault trip during an operation, the inverter will switch to local operation mode at power-on, and full control of the inverter will be with the keypad. The inverter will stop operating when operation mode is switched from "local" to "remote". In this case, a run command through an input terminal will work only after all the input terminals have been turned off.

Inverter Operation During Local/Remote Switching

Switching operation mode from "remote" to "local" while the inverter is running will cause the inverter to stop operating. Switching operation mode from "local" to "remote", however, will cause the inverter to operate based on the command source:

- Analog commands via terminal input: The inverter will continue to run without interruption based on the command at the terminal block. If a reverse operation (Rx) signal is ON at the terminal block at startup, the inverter will operate in the reverse direction even if it was running in the forward direction in local operation mode before the reset.
- Digital source commands: All command sources, except terminal block command sources (which are analog sources), are digital command sources that include the keypad, LCD keypad, and communication sources. The inverter stops operating when switching to remote operation mode, and then starts operating when the next command is given.

7.7 Forward or Reverse Run Prevention

The rotation direction of motors can be configured to prevent motors from running in a forward or reverse direction. When reverse direction prevention is configured, pressing the [REV] key on the keypad will cause the motor to decelerate to 0 Hz and stop.

Group	Code	Name	LCD Display	Parameter Setting	Setting Range	Unit	
ADV	09	Run prevention options	Run Prevent	0	None	0-2	-
				1	Forward Prev		
				2	Reverse Prev		

Forward/Reverse Run Prevention Setting Details

Code	Description		
ADV-09 Run Prevent	Choose a direction to prevent.		
	Setting		Description
	0	None	Do not set run prevention.
	1	Forward Prev	Set forward run prevention.
2	Reverse Prev	Set reverse run prevention.	

7.8 Power-on Run

The Power-on Run feature can be set up to start an inverter operation after powering up based on the run commands by terminal inputs (if they are configured).

⚠ Caution

Use caution when operating the inverter with Power-on Run enabled as the motor will begin rotating when the inverter starts up.

To enable Power-on Run, set DRV-06 (command source) to “1 (Fx/Rx-1)” or “2 (Fx/Rx-2)” and ADV-10 to “1”. If a run command via a terminal input is on, the inverter starts operating according to the terminal input settings as soon as it is turned on.

Group	Code	Name	LCD Display	Parameter Setting		Setting Range	Unit
DRV	06	Command source	Cmd Source	1, 2	Fx/Rx-1 or Fx/Rx-2	0-5	-
ADV	10	Power-on run	Power-on Run	1	Yes	0-1	-

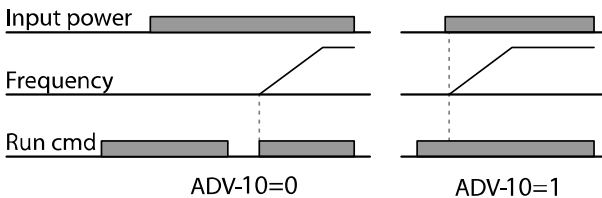

Note

- To prevent a repeat fault trip from occurring when a load, such as a fan, is free-running on a Power-on Run, set CON-71 (speed search options) bit 4 to “1”. The inverter will perform a speed search at the beginning of the operation. If the speed search is not enabled, the inverter will start its operation in a normal V/F pattern and accelerate the motor.
- If the inverter has been turned on without Power-on Run enabled, the terminal block command must be first turned off, and then turned on again to begin the inverter’s operation.

7.9 Reset and Restart

The reset and restart operations can be set up for inverter operation following a fault trip, based on the terminal block operation command (if it is configured).

⚠ Caution

- Use caution when operating the inverter with reset and restart enabled as the motor will begin rotating when the inverter starts up.
- Stop the frequency reference signal if you do not want the inverter to run again after a reset.

Set PRT-08 (RST Restart) to “1 (yes)” to allow the inverter to start operating after it is reset if a fault trip occurs. PRT-10 (Retry Delay) sets the delay time for a restart (the time the inverter will wait before it restarts).

The number of auto-restarts (PRT-09) refers to the number of times the inverter will try restarting its operation. If fault trips occur again after a restart, the retry number counts down each time the inverter restarts until the number becomes “0”. Once the inverter restarts successfully after the initial fault trip, the inverter does not restart until the next fault trip occurs. The number of auto-restarts set at PRT-09 that decreased after a restart reverts to the original setting value if successful operation continues for a certain period of time.

Group	Code	Name	LCD Display	Parameter Setting		Setting Range	Unit
DRV	06	Command source	Cmd Source	1	Fx/Rx-1	1-2	-
				2	Fx/Rx-2		
PRT	08	Reset restart setup	RST Restart	1	Yes	No(0) [default] / Yes(1)	-
	09	No. of auto restart	Retry Number	1		0-10	-

Group	Code	Name	LCD Display	Parameter Setting	Setting Range	Unit
	10	Auto restart delay time	Retry Delay	1.0	0-60.0	sec

Frequency

Reset

Run cmd

PRT-08=0

PRT-08=1

Note

- To prevent a repeat fault trip from occurring, set the CON-71 (Speed search options) bit 2 to "1". The inverter will perform a speed search at the beginning of the operation. If the speed search is not enabled, the inverter will start its operation in a normal V/F pattern and accelerate the motor.
- If the inverter has been turned on without "reset and restart" enabled, the terminal block command must first be turned off and then turned on again to begin inverter operation.

7.10 Setting Acceleration and Deceleration Times

7.10.1 Acc/Dec Time Based on Maximum Frequency

Regardless of the operating frequency, acc/dec time values can be set based on the maximum frequency. To set acc/dec time values based on the maximum frequency, set BAS-08 (Acc/Dec reference) to "0 (Max Freq)".

The acceleration time set at DRV-03 (Acceleration time) refers to the time required for the inverter to reach the maximum frequency from a stopped state (0 Hz). Likewise, the value set at DRV-04 (Deceleration time) refers to the time required to return to a stopped state (0 Hz) from the maximum frequency.

Group	Code	Name	LCD Display	Parameter Setting	Setting Range	Unit	
DRV	03	Acceleration time	Acc Time	75 kW and less	20.0	0.0-600.0	sec
				90 kW and up	60.0		
	04	Deceleration time	Dec Time	75 kW and less	30.0	0.0-600.0	sec
				90 kW and up	90.0		
20	Maximum	Max Freq	60.00	0.00-400.00	Hz		

Group	Code	Name	LCD Display	Parameter Setting		Setting Range	Unit
BAS		frequency					
	08	Acc/Dec reference	Ramp T Mode	0	Max Freq	Max Freq/Delta Freq	-
	09	Time scale	Time scale	1	0.1	0-2 (0.01/0.1/1)	sec

Acc/Dec Time Based on Maximum Frequency – Setting Details

Code	Description								
BAS-08 Ramp T Mode	Set BAS-08 to "0 (Max Freq)" to setup acc/dec time based on maximum frequency.								
	<table border="1"> <thead> <tr> <th>Configuration</th> <th>Description</th> </tr> </thead> <tbody> <tr> <td>0</td> <td>Max Freq</td> </tr> <tr> <td>1</td> <td>Delta Freq</td> </tr> </tbody> </table>	Configuration	Description	0	Max Freq	1	Delta Freq		
	Configuration	Description							
	0	Max Freq							
1	Delta Freq								
<p>If, for example, the maximum frequency is 60.00 Hz, the acc/dec times are set to 5 seconds, and the frequency reference for operation is set at 30 Hz (half of 60 Hz). Therefore, the time required to reach 30 Hz is 2.5 seconds (half of 5 seconds).</p>									
BAS-09 Time scale	Use the time scale for all time-related values. It is particularly useful when more accurate acc/dec times are required, due to load characteristics, or when the maximum time range needs to be extended.								
	<table border="1"> <thead> <tr> <th>Configuration</th> <th>Description</th> </tr> </thead> <tbody> <tr> <td>0</td> <td>0.01 sec</td> </tr> <tr> <td>1</td> <td>0.1 sec</td> </tr> <tr> <td>2</td> <td>1 sec</td> </tr> </tbody> </table>	Configuration	Description	0	0.01 sec	1	0.1 sec	2	1 sec
	Configuration	Description							
	0	0.01 sec							
1	0.1 sec								
2	1 sec								

⚠ Caution

Note that the range of maximum time values may change automatically when the units are changed. If for example, the acceleration time is set to 6000 seconds, a time scale change from 1 second to 0.01 second will result in a modified acceleration time of 60.00 seconds.

7.10.2 Acc/Dec Time Based on Operation Frequency

Acc/Dec times can be set based on the time required to reach the next frequency from the existing operation frequency. To set the acc/dec time values based on the existing operation frequency, set BAS-08 (Acc/Dec reference) to "1 (Delta Freq)".

Group	Code	Name	LCD Display	Settings	Setting Range	Unit
DRV	03	Acceleration time	Acc Time	20.0	0.0 - 600.0	sec
	04	Deceleration time	Dec Time	30.0	0.0 - 600.0	sec
BAS	08	Acc/Dec reference	Ramp T Mode	1 Delta Freq	Max Freq/Delta Freq	-

Acc/Dec Time Based on Operation Frequency– Setting Details

Code	Description						
BAS-08 Ramp T Mode	Set BAS-08 to "1 (Delta Freq)" to set acc/dec times based on operation frequency.						
	<table border="1"> <thead> <tr> <th>Configuration</th> <th>Description</th> </tr> </thead> <tbody> <tr> <td>0 Max Freq</td> <td>Set the acc/dec time based on the maximum frequency.</td> </tr> <tr> <td>1 Delta Freq</td> <td>Set the acc/dec time based on the operating frequency.</td> </tr> </tbody> </table>	Configuration	Description	0 Max Freq	Set the acc/dec time based on the maximum frequency.	1 Delta Freq	Set the acc/dec time based on the operating frequency.
	Configuration	Description					
	0 Max Freq	Set the acc/dec time based on the maximum frequency.					
1 Delta Freq	Set the acc/dec time based on the operating frequency.						
If the acc/dec times are set to 5 seconds, and multiple frequency references are used in the operation in 2 steps, at 10 Hz and 30 Hz, each acceleration stage will take 5 seconds (refer to the graph below).							

7.10.3 Multi-Step Acc/Dec Time Configuration

The acc/dec times can be configured via a multi-function terminal by setting the ACC (acceleration time) and DEC (deceleration time) codes in the DRV group.

Group	Code	Name	LCD Display	Parameter Setting		Setting Range	Unit
DRV	03	Acceleration time	Acc Time	75 kW and less	20.0	0.0–600.0	sec
				90 kW and up	60.0		
	04	Deceleration time	Dec Time	75 kW and less	30.0	0.0–600.0	sec
				90 kW and up	90.0		
BAS	70, 72, 74	Multi-step acceleration time1–3	Acc Time–x	x.xx		0.0–600.0	sec
	71, 73, 75	Multi-step deceleration time1–3	Dec Time–x	x.xx		0.0–600.0	sec
IN	65–75	Px terminal configuration	Px Define (Px: P1–P8 [optional: P9–P11])	11	XCEL-L	-	-
				12	XCEL-M		
				49	XCEL-H		
	89	Multi-step command delay time	In Check Time	1		1–5000	ms

Acc/Dec Time Setup via Multi-function Terminals – Setting Details

Code	Description											
BAS-70, 72, 74 Acc Time 1–3	Set multi-step acceleration time 1–3.											
BAS-71, 73, 75 Dec Time 1–3	Set multi-step deceleration time 1–3.											
IN-65–75 Px Define (P1–P8 [optional P9–P11])	Choose and configure the terminals to use for multi-step acc/dec time inputs.											
	<table border="1"> <thead> <tr> <th>Configuration</th> <th>Description</th> </tr> </thead> <tbody> <tr> <td>11</td> <td>XCEL-L</td> <td>Acc/Dec command-L</td> </tr> <tr> <td>12</td> <td>XCEL-M</td> <td>Acc/Dec command-M</td> </tr> <tr> <td>49</td> <td>XCEL-H</td> <td>Acc/Dec command-H</td> </tr> </tbody> </table>	Configuration	Description	11	XCEL-L	Acc/Dec command-L	12	XCEL-M	Acc/Dec command-M	49	XCEL-H	Acc/Dec command-H
	Configuration	Description										
	11	XCEL-L	Acc/Dec command-L									
12	XCEL-M	Acc/Dec command-M										
49	XCEL-H	Acc/Dec command-H										

Code	Description															
	<p>acc/dec commands are recognized as binary code inputs and will control the acceleration and deceleration based on parameter values set at BAS-70~75</p> <p>If, for example, the P7 and P8 terminals are set as XCEL-L and XCEL-M respectively, the following operation will be available.</p> <table border="1"> <thead> <tr> <th>Acc/Dec time</th> <th>P8</th> <th>P7</th> </tr> </thead> <tbody> <tr> <td>0</td> <td>-</td> <td>-</td> </tr> <tr> <td>1</td> <td>-</td> <td>✓</td> </tr> <tr> <td>2</td> <td>✓</td> <td>-</td> </tr> <tr> <td>3</td> <td>✓</td> <td>✓</td> </tr> </tbody> </table> <p>[Multi-function terminal P7, P8 configuration]</p>	Acc/Dec time	P8	P7	0	-	-	1	-	✓	2	✓	-	3	✓	✓
Acc/Dec time	P8	P7														
0	-	-														
1	-	✓														
2	✓	-														
3	✓	✓														
IN-89 In Check Time	<p>Set the time for the inverter to check for other terminal block inputs. If IN-89 is set to 100 ms and a signal is supplied to the P6 terminal, the inverter searches for other inputs over the next 100 ms. When the time expires, the acc/dec time will be set based on the input received at P6.</p>															

7.10.4 Configuring Acc/Dec Time Switch Frequency

By configuring the switch frequency, you can switch between two different sets of acc/dec times (acc/dec gradients) without configuring the multi-function terminals.

Group	Code	Name	LCD Display	Parameter Setting	Setting Range	Unit
DRV	03	Acceleration time	Acc Time	10.0	0.0~600.0	sec
	04	Deceleration time	Dec Time	10.0	0.0~600.0	sec
BAS	70	Multi-step acceleration time1	Acc Time-1	20.0	0.0~600.0	sec

Basic Functions

Group	Code	Name	LCD Display	Parameter Setting	Setting Range	Unit
	71	Multi-step deceleration time1	Dec Time-1	20.0	0.0–600.0	sec
ADV	60	Acc/dec time switch frequency	Xcel Change Fr	30.00	0–Maximum frequency	Hz/RPM

Acc/Dec Time Switch Frequency Setting Details

Code	Description
ADV-60 Xcel Change Fr	<p>After the acc/dec switch frequency has been set, the acc/dec gradients configured at BAS-70 and 71 will be used when the inverter's operation frequency is at or below the switch frequency. If the operation frequency exceeds the switch frequency, the gradient level configured for the acceleration and deceleration times (set at DRV-03 and DRV-04) will be used. If you configure the P1–P8 [optional: P9–P11] multi-function input terminals for multi-step acc/dec gradients (XCEL-L, XCEL-M, XCEL-H), the inverter will operate based on the acc/dec inputs at the terminals regardless of the acc/dec switch frequency configurations.</p> <p>Run cmd</p>

7.11 Acc/Dec Pattern Configuration

The acc/dec gradient level patterns can be configured to enhance and smooth out the inverter's acceleration and deceleration curves. A linear pattern features a linear increase or decrease to the output frequency, at a fixed rate. An S-curve pattern offers a smoother and more gradual increase or decrease of output frequency, ideal for lift-type loads or elevator doors, etc. The S-curve gradient level can be adjusted using codes ADV-03-06 in the advanced group.

Group	Code	Name	LCD Display	Parameter Setting		Setting Range	Unit
BAS	08	Acc/dec reference	Ramp T mode	0	Max Freq	0-1	-
ADV	01	Acceleration pattern	Acc Pattern	0	Linear	0-1	-
				1	S-curve		
	02	Deceleration pattern	Dec Pattern	0	Linear	0-1	-
				1	S-curve		
	03	S-curve acc start gradient	Acc S Start	40		1-100	%
	04	S-curve acc end gradient	Acc S End	40		1-100	%
	05	S-curve dec start gradient	Dec S Start	40		1-100	%
06	S-curve dec end gradient	Dec S End	40		1-100	%	

Acc/Dec Pattern Setting Details

Code	Description
ADV-03 Acc S Start	Sets the gradient level as acceleration starts when using an S-curve, acc/dec pattern. ADV-03 defines the S-curve gradient level as a percentage up to half of the total acceleration. If the frequency reference and maximum frequency are set at 60 Hz and ADV-03 is set to 50%, ADV-03 configures the acceleration up to 30 Hz (half of 60 Hz). The inverter will perform S-curve acceleration in the 0-15 Hz frequency range (50% of 30 Hz). Linear acceleration will be applied to the remaining acceleration within the 15-30 Hz frequency range.
ADV-04 Acc S End	Sets the gradient level as acceleration ends when using an S-curve acc/dec

Code	Description
	<p>pattern. ADV-03 defines S-curve gradient level as a percentage, above half of the total acceleration.</p> <p>If the frequency reference and the maximum frequency are set at 60 Hz and ADV-04 is set to 50%, setting ADV-04 configures acceleration to increase from 30 Hz (half of 60 Hz) to 60 Hz (end of acceleration). Linear acceleration will be applied within the 30-45 Hz frequency range. The inverter will perform an S-curve acceleration for the remaining acceleration in the 45-60 Hz frequency range.</p>
ADV-05 Dec S Start – ADV-06 Dec S End	Sets the rate of S-curve deceleration. Configuration for codes ADV-05 and ADV-06 may be performed the same way as configuring codes ADV-03 and ADV-04.

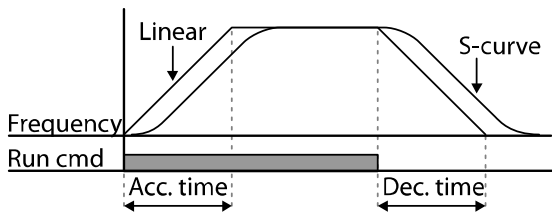

[Acceleration / deceleration pattern configuration]

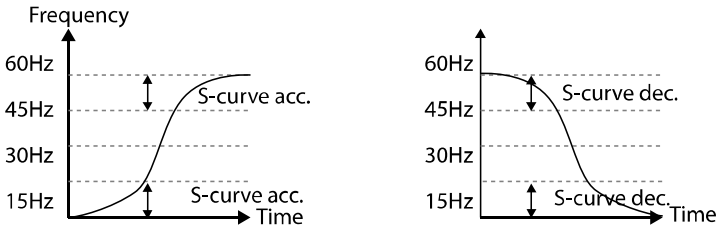
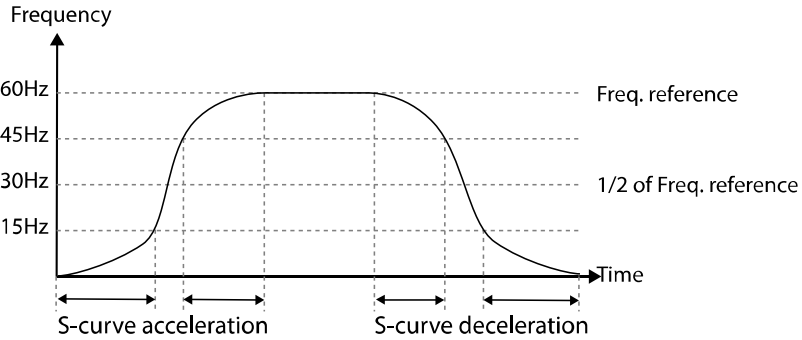

[Acceleration / deceleration S-curve pattern configuration]

Note

The actual acc/dec time during an S-curve application

The actual acceleration time = user-configured acceleration time + user-configured acceleration time x starting gradient level/2 + user-configured acceleration time x ending gradient level/2.

The actual deceleration time = user-configured deceleration time + user-configured deceleration time x starting gradient level/2 + user-configured deceleration time x ending gradient level/2.

⚠ Caution

Note that actual acc/dec times become greater than the user-defined acc/dec times when S-curve acc/dec patterns are in use.

7.12 Stopping the Acc/Dec Operation

Configure the multi-function input terminals to stop acceleration or deceleration and operate the inverter at a fixed frequency.

Group	Code	Name	LCD Display	Parameter Setting		Setting Range	Unit
IN	65-75	Px terminal configuration	Px Define (Px: P1-P8 [optional: P9-P11])	25	XCEL Stop	0-51	-

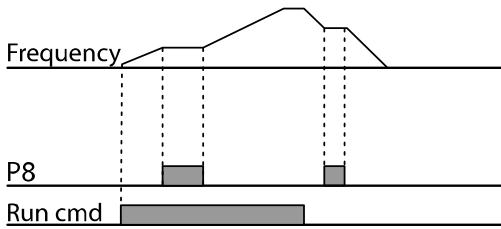

7.13 V/F (Voltage/Frequency) Control

Configure the inverter's output voltages, gradient levels, and output patterns to achieve a target output frequency with the V/F control. The amount of torque boost used during low frequency operations can also be adjusted.

7.13.1 Linear V/F Pattern Operation

A linear V/F pattern configures the inverter to increase or decrease the output voltage at a fixed rate for different operation frequencies based on V/F characteristics. A linear V/F pattern is particularly useful when a constant torque load is applied.

Group	Code	Name	LCD Display	Parameter Setting		Setting Range	Unit
DRV	09	Control mode	Control Mode	0	V/F	-	-
	18	Base frequency	Base Freq	60.00		30.00–400.00	Hz
	19	Start frequency	Start Freq	0.50		0.01–10.00	Hz
BAS	07	V/F pattern	V/F Pattern	0	Linear	-	-

Linear V/F Pattern Setting Details

Code	Description
DRV-18 Base Freq	Sets the base frequency. A base frequency is the inverter's output frequency when running at its rated voltage. Refer to the motor's rating plate to set this parameter value.
DRV-19 Start Freq	<p>Sets the start frequency. A start frequency is a frequency at which the inverter starts voltage output. The inverter does not produce an output voltage while the frequency reference is lower than the set frequency. However, if a deceleration stop is made while operating above the start frequency, the output voltage will continue until the operation frequency reaches a full stop (0 Hz).</p>

7.13.2 Square Reduction V/F Pattern Operation

Square reduction V/F pattern is ideal for loads such as fans and pumps. It provides non-linear acceleration and deceleration patterns to sustain torque throughout the entire frequency range.

Group	Code	Name	LCD Display	Parameter Setting		Setting Range	Unit
BAS	07	V/F pattern	V/F Pattern	1	Square	0-3	-
				3	Square2		

Square Reduction V/F pattern Operation - Setting Details

Code	Description	
BAS-07 V/F Pattern	Sets the parameter value to "1 (Square)" or "2 (Square2)" depending on the load's start characteristics.	
	Setting	Function
	1	Square
3	Square2	The inverter produces an output voltage proportionate to 2 square of the operation frequency. This setup is ideal for variable torque loads, such as fans or pumps.

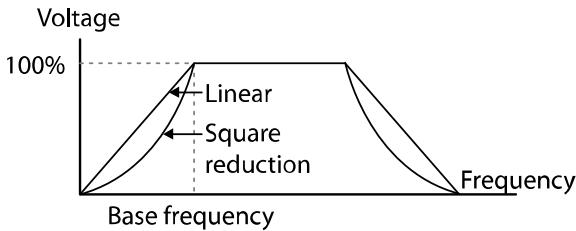

7.13.3 User V/F Pattern Operation

The iS7 inverter allows the configuration of user-defined V/F patterns to suit the load characteristics of a specific motor.

Group	Code	Name	LCD Display	Parameter Setting		Setting Range	Unit
BAS	07	V/F pattern	V/F Pattern	2	User V/F	0-2	-
	41	User frequency 1	User Freq 1	15.00		0-Maximum frequency	Hz
	42	User voltage 1	User Volt 1	25		0-100%	%
	43	User frequency 2	User Freq 2	30.00		0-Maximum frequency	Hz
	44	User voltage 2	User Volt 2	50		0-100%	%
	45	User frequency 3	User Freq 3	45.00		0-Maximum frequency	Hz
	46	User voltage 3	User Volt 3	75		0-100%	%
	47	User frequency 4	User Freq 4	60		0-Maximum frequency	Hz
	48	User voltage 4	User Volt 4	100		0-100%	%

User V/F pattern Setting Details

Code	Description
BAS-41 User Freq 1 -BAS-48 User Volt 4	Sets the parameter values to assign user-defined frequencies (User Freq x) for the start and maximum frequencies. Voltages can also be set to correspond with each frequency, and for each user voltage (User Volt x).

Basic Functions

The 100% output voltage in the figure below is based on the parameter settings of BAS-15 (motor rated voltage). If BAS-15 is set to "0," it will be based on the input voltage.

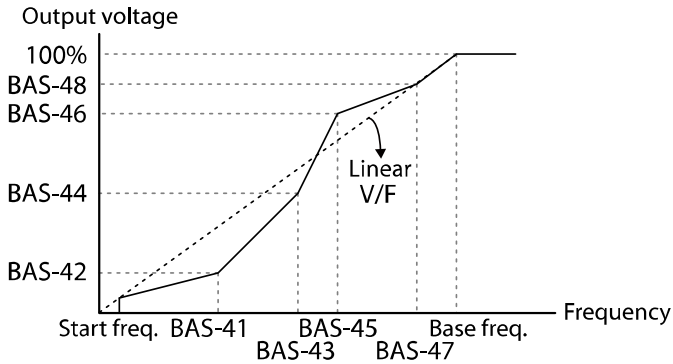

⚠ Caution

- When a normal induction motor is in use, care must be taken not to change the output pattern from a linear V/F pattern. Non-linear V/F patterns may cause insufficient motor torque or motor overheating due to over-excitation.
- When a user V/F pattern is in use, the forward torque boost (DRV-16) and reverse torque boost (DRV-17) will not operate.

7.14 Torque Boost

7.14.1 Manual Torque Boost

Manual torque boost enables users to adjust the output voltage during low-speed operation or motor start. You can increase the low-speed torque or improve motor-starting properties by manually increasing the output voltage. Configure the manual torque boost while running loads that require a high starting torque, such as lift-type loads.

Group	Code	Name	LCD Display	Parameter Setting		Setting Range	Unit
DRV	15	Torque boost options	Torque Boost	0	Manual	0-1	-
	16	Forward torque boost	Fwd Boost*	2.0		0.0-15.0	%
	17	Reverse torque boost	Rev Boost*	2.0		0.0-15.0	%

* For 90 kW-160 kW model types, the default setting value is 1.0 [%].

Manual Torque Boost Setting Details

Code	Description
DRV-16 Fwd Boost	Sets the torque boost for forward operation.
DRV-17 Rev Boost	Sets the torque boost for reverse operation.

$$\begin{aligned}
 \text{Output Voltage} &= \text{Output voltage affected by DRV-16,17 Manual torque boost parameter} \\
 &= V/F \text{ voltage} + \text{Boosted voltage} \\
 &= (\text{Maximum voltage} - \text{Boosted voltage}) \times \frac{\text{Current frequency}}{\text{Base frequency}} + \text{Boosted voltage}
 \end{aligned}$$

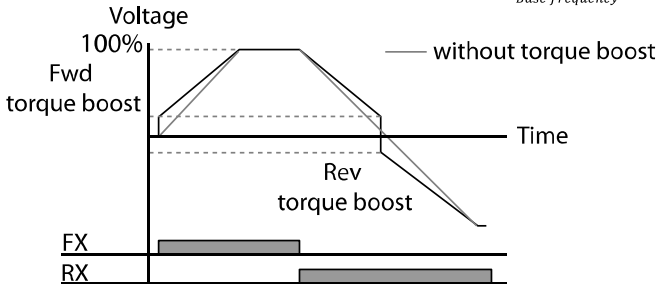

⚠ Caution

Excessive torque boost will result in over-excitation and motor overheating.

7.14.2 Auto Torque Boost

Set DRV-15 to “1 (Auto)” to enable auto torque boost. While manual torque boost adjusts the inverter output based on the setting values, regardless of the type of load used during the operation, auto torque boost enables the inverter to automatically calculate the amount of output voltage required for the torque boost based on the entered motor parameters.

Because auto torque boost requires motor-related parameters, such as stator resistance, inductance, and no-load current, auto tuning (BAS-20) has to be performed before the auto torque boost can be configured. Similarly to manual torque boost, configure auto torque boost while running a load that requires high starting torque, such as lift-type loads. Refer to [8.9 Auto Tuning](#) on page 224.

Group	Code	Name	LCD Display	Parameter Setting	Setting Range	Unit
DRV	15	Torque boost mode	Torque Boost	1 Auto	0–2	-
BAS	20	Auto tuning	Auto Tuning	2 Rs+Lsigma	0–3	-

7.14.3 Advanced Auto Torque Boost

Manual Torque Boost, regardless of load characteristics, outputs the inverter voltage according to the torque boost amount set by the user. Auto Torque Boost automatically calculates the boost amount, but auto tuning the motor is required. For Advanced Auto Torque Boost, the inverter outputs the inverter voltage by adjusting the boost amount according to the load itself without auto tuning the motor.

Advanced Automatic Torque Boost is adjusted according to the load determined by the Adv ATB M Gain, Adv ATB G Gain of DRV-27 and 28 values and it can be used when starting torque is insufficient or when excessive current flows..

Group	Code	Name	LCD Display	Parameter Setting	Setting Range	Unit
DRV	15	Torque boost mode	Torque Boost	2 Advanced Auto	0–2	-
	16	Fwd Boost ^{Note1)}	Fwd Boost	2.0	0-15	%

Group	Code	Name	LCD Display	Parameter Setting	Setting Range	Unit
	17	Rev Boost ^{Note2)}	Rev Boost	2.0	0-15	%
	26	Adv ATB Filter	Adv ATB Filter	100	1-1000	msec
	27	Adv ATB M Gain	Adv ATB M Gain	50.0	0-300.0	%
	28	Adv ATB G Gain	Adv ATB G Gain	50.0	0-300.0	%

* Note 1, Note 2) For 90 kW – 160 kW products, the factory shipment value is 1.0 [%].

Advanced Auto Torque Boost Setting Details

Code	Description
DRV-16 Fwd Boost	Adjusts the torque boost amount for forward rotation
DRV-17 Rev Boost	Adjusts the torque boost amount for reverse rotation.
DRV-26 Adv ATB Filter	Filter gain for calculating the Auto Torque Boost value.
DRV-27 Adv ATB M Gain	Gain for calculating the reverse Auto Torque Boost value.
DRV-28 Adv ATB G Gain	Gain for calculating the regeneration Auto Torque Boost value.

If there is no load, the additional voltage amount due to Auto Torque Boost is 0, which gives the same result as the normal manual boost.

When the load is applied, the amount of compensation voltage varies depending on the operation and reverse directions.

If you set the DRV-16 and DRV-17 values differently when using Advanced Auto Torque Boost at no load, a current hunting operation may occur.

Output voltage = Primary output voltage + Secondary output voltage

· ***Primary output voltage***

= Output voltage affected by DRV-16,17 Manual torque boost parameter

$$= (\text{Maximum voltage} - \text{Boosted voltage}) \times \frac{\text{Current frequency}}{\text{Base frequency}} + \text{Boosted voltage}$$

· ***Secondary output voltage***

= Output voltage affected by DRV-27,28 ATB M/G Gain parameter and motor load

$$= \text{Motor rated slip frequency} \times \frac{\text{Motor max phase voltage}}{\text{Base frequency}} \times \text{ATB M/G Gain} \times \frac{\text{Current output current}}{\text{Motor rated current}}$$

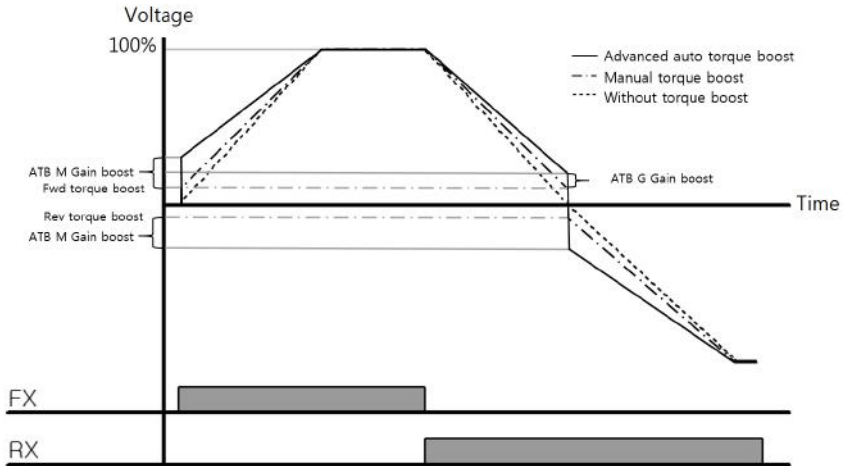

⚠ Caution

If the torque boost amount is set too large, overheating of the motor due to over-excitation will occur.

7.15 Output Voltage Setting

Output voltage settings are required when a motor's rated voltage differs from the input voltage to the inverter. Set BAS-15 to configure the motor's rated operating voltage. The set voltage becomes the output voltage of the inverter's base frequency. When the inverter operates above the base frequency, and when the motor's voltage rating is lower than the input voltage at the inverter, the inverter adjusts the voltage and supplies the motor with the voltage set at BAS-15 (motor-rated voltage). If the motor's rated voltage is higher than the input voltage at the inverter, the inverter will supply the inverter input voltage to the motor.

If BAS-15 (motor-rated voltage) is set to "0," the inverter corrects the output voltage based on the input voltage in the stopped condition. If the frequency is higher than the base frequency and when the input voltage is lower than the parameter setting, the input voltage will be the inverter output voltage.

Group	Code	Name	LCD Display	Parameter Setting	Setting Range	Unit
BAS	15	Motor rated voltage	Rated Volt	220	0, 180–480	V

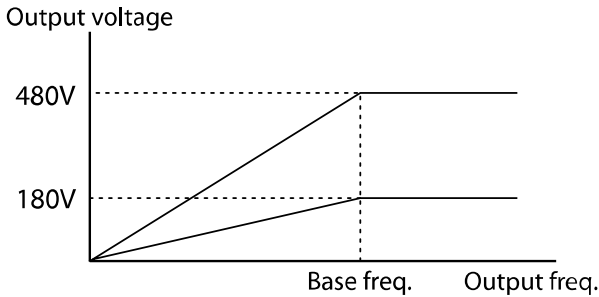

7.16 Start Mode Setting

Select the start mode to use when the operation command is input with the motor in the stopped condition.

7.16.1 Acceleration Start

Acceleration start is a general acceleration mode. If there are no extra settings applied, the motor accelerates directly to the frequency reference when the command is input.

Group	Code	Name	LCD Display	Parameter Setting	Setting Range	Unit
ADV	07	Start mode	Start mode	0	Acc	-

7.16.2 Start After DC Braking

This start mode supplies a DC voltage for a set amount of time to provide DC braking before an inverter starts to accelerate a motor. If the motor continues to rotate due to inertia, DC braking will stop the motor, allowing the motor to accelerate from a stop. DC braking can also be used with a mechanical brake connected to a motor shaft when a constant torque load is applied, if a constant torque is required after the mechanical brake is released.

Group	Code	Name	LCD Display	Parameter Setting	Setting Range	Unit
ADV	07	Start mode	Start Mode	1	DC-Start	-

Basic Functions

Group	Code	Name	LCD Display	Parameter Setting	Setting Range	Unit
	12	Start DC braking time	DC-Start Time	0.00	0.00–60.00	sec
	13	DC Injection Level	DC Inj Level	50	0–200	%

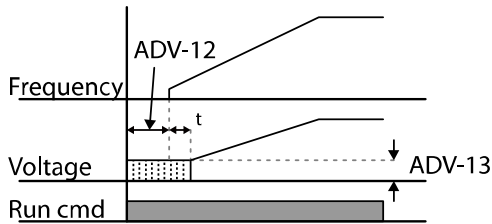

⚠ Caution

The amount of DC braking required is based on the motor's rated current. Do not use DC braking resistance values that can cause current draw to exceed the rated current of the inverter. If the DC braking resistance is too high or brake time is too long, the motor may overheat or be damaged.

7.17 Stop Mode Setting

Select Stop mode to stop the inverter operation.

7.17.1 Deceleration Stop

Deceleration stop is a general stop mode. If there are no extra settings applied, the motor decelerates to 0 Hz and stops, as shown in the figure below.

Group	Code	Name	LCD Display	Parameter Setting	Setting Range	Unit
ADV	08	Stop mode	Stop Mode	0 Dec	-	-

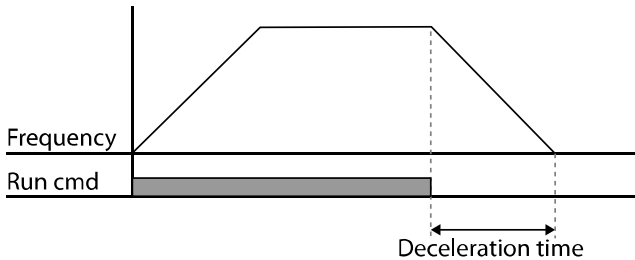

7.17.2 Stop after DC Braking

When the operation frequency reaches the set value during deceleration (DC braking frequency) the inverter stops the motor by supplying DC power to the motor. With a stop command input, the inverter begins decelerating the motor. When the frequency reaches the DC braking frequency set at ADV-17, the inverter supplies DC voltage to the motor and stops it.

Group	Code	Name	LCD Display	Parameter Setting		Setting Range	Unit
ADV	08	Stop mode	Stop Mode	0	Dec	0-4	-
	14	Output block time before braking	DC-Block Time	0.10		0.00-60.00	sec
	15	DC braking time	DC-Brake Time	1.00		0-60	sec
	16	DC braking amount	DC-Brake Level	50		0-200	%
	17	DC braking frequency	DC-Brake Freq	5.00		0.00-60.00	Hz

Note

DC braking does not produce stop torque. Install appropriate peripheral devices if stop torque is required in your application.

DC Braking After Stop Setting Details

Code	Description
ADV-14 DC-Block Time	Sets the time to block the inverter output before DC braking. If the inertia of the load is great, or if the DC braking frequency (ADV-17) is set too high, a fault trip may occur due to overcurrent conditions when the inverter supplies DC voltage

Basic Functions

Code	Description
	to the motor. Prevent overcurrent fault trips by adjusting the output block time before DC braking.
ADV-15 DC-Brake Time	Sets the time duration for the DC voltage supply to the motor.
ADV-16 DC-Brake Level	Sets the amount of DC braking to apply. The parameter setting is based on the rated current of the motor.
ADV-17 DC-Brake Freq	Sets the frequency to start DC braking. When the frequency is reached, the inverter starts deceleration. If the dwell frequency is set lower than the DC braking frequency, the dwell operation will not work and DC braking will start instead.

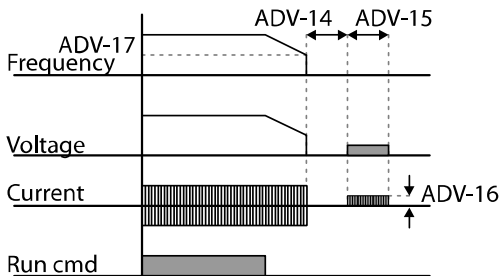

⚠ Caution

- The motor can overheat or be damaged if an excessive amount of DC braking is applied to the motor or if the DC braking time is set to a high value.
- DC braking is configured based on the motor's rated current. To prevent overheating or damaging motors, do not set the current value higher than the inverter's rated current.

7.17.3 Free Run Stop

When the operation command is off, the inverter output turns off, and the load stops due to residual inertia.

Group	Code	Name	LCD Display	Parameter Setting		Setting Range	Unit
ADV	08	Stop mode	Stop Mode	2	Free-Run	0-4	-

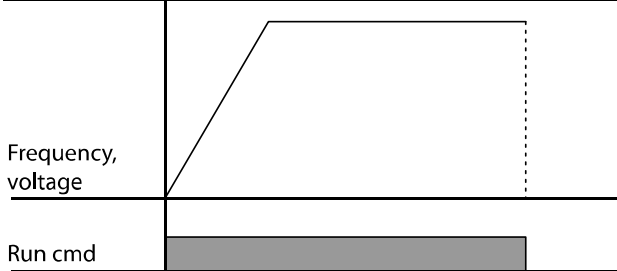

⚠ Caution

When there is high inertia on the output side and the motor is operating at high speed, the load's inertia will cause the motor to continue rotating even after the inverter output is blocked.

7.17.4 Power Braking

When the inverter's DC voltage rises above a specified level due to motor-regenerated energy, a control is made to either adjust the deceleration gradient level or reaccelerate the motor in order to reduce the regenerated energy. Power braking can be used when short deceleration times are needed without braking resistors, or when optimum deceleration is needed without causing an over voltage fault trip.

Group	Code	Name	LCD Display	Parameter Setting		Setting Range	Unit
ADV	08	Stop mode	Stop Mode	4	Power Braking	-	-

⚠ Caution

- To prevent overheating or damaging the motor, do not apply power braking to loads that require frequent deceleration.
- Stall prevention and power braking only operate during deceleration, and power braking takes priority over stall prevention. In other words, when both bit 3 of PRT-50 (stall prevention and flux braking) and ADV-08 (braking options) are set, power braking will take precedence.
- Note that if the deceleration time is too short or the inertia of the load is too great, an

overvoltage fault trip may occur.

- Note that if a free run stop is used, the actual deceleration time may be longer than the preset deceleration time.

7.18 Frequency Limit

The operation frequency can be limited by setting a maximum frequency, start frequency, upper limit frequency, and lower limit frequency.

7.18.1 Frequency Limit Using Maximum Frequency and Start Frequency

Group	Code	Name	LCD Display	Parameter Setting	Setting Range	Unit
DRV	19	Start frequency	Start Freq	0.50	0.01–10.00	Hz
	20	Maximum frequency	Max Freq	60.00	40.00–400.00	Hz

Frequency Limit Using Maximum Frequency and Start Frequency - Setting Details

Code	Description
DRV-19 Start Freq	Sets the lower limit value for all speed unit parameters that are expressed in Hz or rpm. Any operation frequency input that is lower than the start frequency is treated as a 0 Hz input.
DRV-20 Max Freq	Sets an upper limit frequency to all speed unit parameters that are expressed in Hz or rpm, except for the base frequency (DRV-18). An operation frequency cannot be set higher than the maximum frequency.

7.18.2 Frequency Limit Using Upper and Lower Limit Frequency Values

Group	Code	Name	LCD Display	Parameter Setting	Setting Range	Unit
ADV	24	Frequency limit	Freq Limit	0	--- No ---	No/Yes

Group	Code	Name	LCD Display	Parameter Setting		Setting Range	Unit
	25	Frequency lower limit value	Freq Limit Lo	0.50		0.0–maximum frequency	Hz
	26	Frequency upper limit value	Freq Limit Hi	60.00		0.5–maximum frequency	Hz
	34	Jog Frequency Limit	Jog Freq Limit	1	--- Yes ----	No/Yes	-

Frequency Limit Using Upper and Lower Limit Frequencies - Setting Details

Code	Description
ADV-24 Freq Limit	The initial setting is "0 (No)." Changing the setting to "1 (Yes)" allows you to set the lower limit frequency (ADV-25) and the upper limit frequency (ADV-26). When the setting is "0 (No)", codes ADV-25 and ADV-26 are not visible.
ADV-25 Freq Limit Lo ADV-26 Freq Limit Hi	Sets upper and lower frequency limits. All frequency selections are restricted to frequencies from within the upper and lower limits. This restriction also applies when you in input a frequency reference using the keypad.
ADV-34 Jog Freq Limit	This code allows you to select whether to use the frequency limit function with frequency upper/lower limits for jog operations. When ADV-34 is set to "Yes", the frequency limit is applied if the frequency limit function using the frequency upper/lower limits is set the same as a normal operation for jog operations. When ADV-34 is set to "No", the frequency limit value is not applied even if the frequency limit function using the frequency upper/lower limits is set for jog operations. However, the frequency limit for the maximum frequency and the start frequency applies.

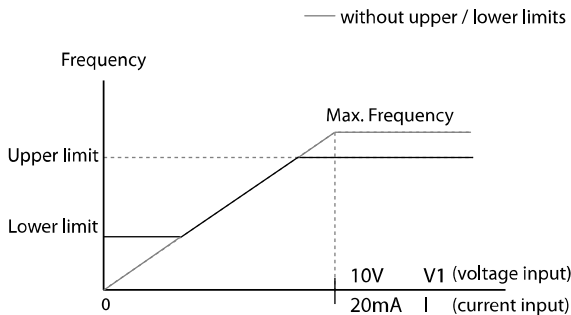

⚠ Caution

- When ADV-24 (Freq Limit) is set to "Yes," the frequency set at ADV-25 (Freq Limit Lo) is the minimum frequency (Low Freq). If ADV-24 (Freq Limit) is set to "No," the frequency set at DRV-19 (Start Freq) becomes the minimum frequency.
- When ADV-24 (Freq Limit) is set to "Yes," the frequency set at ADV-26 (Freq Limit Hi) is the maximum frequency (High Freq). If ADV-24 (Freq Limit) is set to "No," the frequency set at DRV-20 (Max Freq) becomes the maximum frequency.

7.18.3 Frequency Jump

Use frequency jump to avoid mechanical resonance frequencies. The inverter will avoid specific frequency ranges during acceleration and deceleration. Operation frequencies cannot be set within the preset frequency jump band.

When the operation frequency is increased while the frequency parameter setting value (voltage, current, RS-485 communication, keypad setting, etc.) is within a jump frequency band, the frequency will be maintained at the lower limit value of the frequency band. Then, the frequency will increase when the frequency parameter setting exceeds the range of frequencies used by the frequency jump band.

Group	Code	Name	LCD Display	Parameter Setting		Setting Range	Unit
ADV	27	Frequency jump	Jump Freq	0	--- No ---	No/Yes	-
	28	Jump frequency lower limit1	Jump Lo 1	10.00		0.00-Jump frequency upper limit 1	Hz
	29	Jump frequency upper limit1	Jump Hi 1	15.00		Jump frequency lower limit 1-Maximum frequency	Hz
	30	Jump frequency lower limit 2	Jump Lo 2	20.00		0.00-Jump frequency upper limit 2	Hz
	31	Jump frequency upper limit 2	Jump Hi 2	25.00		Jump frequency lower limit 2-Maximum frequency	Hz
	32	Jump frequency lower limit 3	Jump Lo 3	30.00		0.00-Jump frequency upper limit 3	Hz
	33	Jump frequency upper limit 3	Jump Hi 3	35.00		Jump frequency lower limit 3-Maximum frequency	Hz

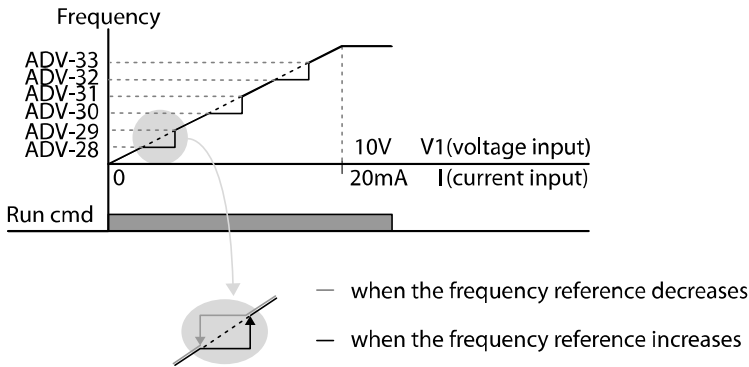

7.19 2nd Operation Mode Setting

Apply two types of operation modes and switch between them as required. For both the first and second command source, set the frequency after shifting operation commands to the multi-function input terminal. Mode switching can be used to stop remote control during an operation using the communication option and to switch the operation mode to operate via the local panel, or to operate the inverter from another remote control location.

Select one of the multi-function terminals from codes IN-65-75 and set the parameter value to "15 (2nd Source)".

Group	Code	Name	LCD Display	Parameter Setting	Unit
DRV	06	Command source	Cmd Source	1 Fx/Rx-1	-
	07	Frequency reference source	Freq Ref Src	2 V1	-
	08	Torque reference source	Trq Ref Src	0 Keypad-1	
BAS	04	2nd command source	Cmd 2nd Src	0 Keypad	-
	05	2nd frequency reference source	Freq 2nd Src	0 KeyPad-1	-
	06	2nd torque reference source	Trq 2 nd Src	0 Keypad-1	
IN	65-75	Px terminal configuration	Px Define (Px: P1-P8 [optional: P9-P11])	15 2nd Source	-

2nd Operation Mode Setting Details

Code	Description
BAS-04 Cmd 2nd Src BAS-05 Freq 2nd Src	If signals are provided to the multi-function terminal set as the 2nd command source (2nd Source), the operation can be performed using the values set at BAS-04–05 instead of the values set at DRV-06 and DRV-07. The 2nd command source settings cannot be changed while operating with the 1st command source (Main Source).
BAS-06 Trq 2nd Src	If signals are provided to the multi-function terminal set as the 2nd command source (2nd Source), the operation can be performed using the torque reference set at BAS-06 instead of the value set at DRV-08. Codes DRV-08 and BAS-06 are visible only when DRV-09 (Control mode) is set to “sensorless” or “vector” control mode, and DRV-10 (Torque control) is set to “Yes.”

⚠ Caution

- When you set the multi-function terminal to the 2nd command source (2nd Source) and input the signal, the inverter's operation state changes according to the operation frequency and the operation command configured for the 2nd command. Before shifting the input to the multi-function terminal, ensure that the 2nd command is correctly set. An overvoltage fault trip may occur if the deceleration time is too short or the inertia of the load is too high.
- Depending on the parameter settings, the inverter may stop operating when you switch command modes.













7.20 Multi-function Input Terminal Control

Filter time constants and the type of multi-function input terminals can be configured to improve the response of the input terminals.

Group	Code	Name	LCD Display	Parameter Setting	Setting Range	Unit
IN	85	Multi-function input terminal On filter	DI On Delay	0	0–10000	ms
	86	Multi-function input terminal Off filter	DI Off Delay	0	0–10000	ms
	87	Multi-function input terminal selection	DI NC/NO Sel	0000 0000*	-	-
	90	Multi-function input terminal status	DI Status	0000 0000*	-	-

* From the last bit to the first, the bits are for multi-purpose inputs P1–P8 (the last bit is for input 1, and the first bit is for input 8).

Multi-function Input Terminal Control Setting Details

Code	Description						
IN-85 DI On Delay, IN-86 DI Off Delay	When the terminal receives an On or Off input signal, it is recognized as an On or Off signal after the set delay time has elapsed.						
IN-87 DI NC/NO Sel	<p>Selects terminal contact types for each input terminal. The position of the dot corresponds to the segment that is on as shown in the table below. With the bottom segment on, it indicates that the terminal is configured as an A terminal (Normally Open) contact. With the top segment on, it indicates that the terminal is configured as a B terminal (Normally Closed) contact. Terminals are numbered P1–P8, from right to left.</p> <table border="1"> <thead> <tr> <th>Type</th> <th>B terminal status (Normally Closed)</th> <th>A terminal status (Normally Open)</th> </tr> </thead> <tbody> <tr> <td>Keypad</td> <td></td> <td></td> </tr> </tbody> </table>	Type	B terminal status (Normally Closed)	A terminal status (Normally Open)	Keypad		
Type	B terminal status (Normally Closed)	A terminal status (Normally Open)					
Keypad							
IN-90 DI Status	<p>Displays the configuration of each contact. When a segment is configured as an A terminal at DRV-87, the On condition is indicated by the top segment turning on. The Off condition is indicated when the bottom segment is turned on. When contacts are configured as B terminals, the segment dots behave conversely. Terminals are numbered P1–P8, from right to left.</p> <table border="1"> <thead> <tr> <th>Type</th> <th>A terminal setting (On)</th> <th>A terminal setting (Off)</th> </tr> </thead> <tbody> <tr> <td>Keypad</td> <td></td> <td></td> </tr> </tbody> </table>	Type	A terminal setting (On)	A terminal setting (Off)	Keypad		
Type	A terminal setting (On)	A terminal setting (Off)					
Keypad							

7.21 Expanded I/O Control with an Optional I/O Expansion Module

You can install an I/O expansion module to add 3 digital input and 3 digital output (relay output) multi-function terminals to the iS7 inverter. The following table lists the function codes to control the expanded I/O functions.

Group	Code	Name	LCD Display	Parameter Setting		Unit
IN	73	Px terminal configuration (P9 terminal function)	P9 Define	0	None	-
	74	Px terminal configuration (P10 terminal function)	P10 Define	0	None	-
	75	Px terminal configuration (P11 terminal function)	P11 Define	0	None	-
OUT	34	Multi-function relay-3	Relay 3	2	FDT-2	-
	35	Multi-function relay-4	Relay 4	3	FDT-3	-
	36	Multi-function relay-5	Relay 5	4	FDT-4	-

8 Learning Advanced Features

This chapter describes the advanced features of the iS7 inverter.

8.1 Operating with Auxiliary References

Frequency references can be configured with various calculated conditions that use the main and auxiliary frequency references simultaneously. The main frequency reference is used as the operating frequency, while auxiliary references are used to modify and fine-tune the main reference.

Group	Code	Name	LCD Display	Parameter Setting		Setting Range	Unit
DRV	07	Frequency reference source	Freq Ref Src	0	Keypad-1	0–9	-
BAS	01	Auxiliary frequency reference source	Aux Ref Src	1	V1	0–5	-
	02	Auxiliary frequency reference calculation type	Aux Calc Type	0	M+(G*A)	0–7	-
	03	Auxiliary frequency reference gain	Aux Ref Gain	-	0.00	-200.0–200.0	%
IN	65–75	Px terminal configuration	Px Define	36	dis Aux Ref	0–48	-

* Codes IN-01–16 must be set to the default values, and IN-06 (V1 Polarity), set to “1 (Bipolar)”.

The table above lists the available calculated conditions for the main and auxiliary frequency references. Refer to the table to see how the calculations apply to an example where the DRV-07 Frq Src code has been set to “0 (Keypad-1)”, and the inverter is operating at a main reference frequency of 30.00 Hz. Signals at -10 to +10 V are received at terminal V1, with the reference gain set at 5%. In this example, the resulting frequency reference is fine-tuned within the range of 27.00–33.00 Hz* (+/- 5% of 60 Hz).

Auxiliary Reference Setting Details

Code	Description	
BAS-01 Aux Ref Src	Sets the input type to be used for the auxiliary frequency reference.	
	Configuration	Description
	0	None

Code	Description																		
	<table border="1"> <tr> <td>1</td> <td>V1</td> <td>Sets the V1 (voltage) terminal at the control terminal block as the source of the auxiliary frequency reference.</td> </tr> <tr> <td>2</td> <td>I1</td> <td>Sets the I1 (current) terminal at the control terminal block as the source of the auxiliary frequency reference.</td> </tr> <tr> <td>3</td> <td>V2</td> <td>Sets the V2 (voltage) terminal at the optional I/O expansion module as the source of the auxiliary frequency reference.</td> </tr> <tr> <td>4</td> <td>I2</td> <td>Sets the I2 (current) terminal at the optional I/O expansion module as the source of the auxiliary frequency reference.</td> </tr> <tr> <td>5</td> <td>Pulse</td> <td>Sets the pulse input terminal at the optional encoder module as the source of the auxiliary frequency reference.</td> </tr> </table>	1	V1	Sets the V1 (voltage) terminal at the control terminal block as the source of the auxiliary frequency reference.	2	I1	Sets the I1 (current) terminal at the control terminal block as the source of the auxiliary frequency reference.	3	V2	Sets the V2 (voltage) terminal at the optional I/O expansion module as the source of the auxiliary frequency reference.	4	I2	Sets the I2 (current) terminal at the optional I/O expansion module as the source of the auxiliary frequency reference.	5	Pulse	Sets the pulse input terminal at the optional encoder module as the source of the auxiliary frequency reference.			
1	V1	Sets the V1 (voltage) terminal at the control terminal block as the source of the auxiliary frequency reference.																	
2	I1	Sets the I1 (current) terminal at the control terminal block as the source of the auxiliary frequency reference.																	
3	V2	Sets the V2 (voltage) terminal at the optional I/O expansion module as the source of the auxiliary frequency reference.																	
4	I2	Sets the I2 (current) terminal at the optional I/O expansion module as the source of the auxiliary frequency reference.																	
5	Pulse	Sets the pulse input terminal at the optional encoder module as the source of the auxiliary frequency reference.																	
BAS-02 Aux Calc Type	<p>Sets the auxiliary reference gain with BAS-03 (Aux Ref Gain) to configure the auxiliary reference and set BAS-02 to decide the percentage to be reflected when calculating the main reference. Note that items 4–7 below may result in either plus (+) or minus (-) references (forward or reverse operation) even when unipolar analog inputs are used.*</p> <table border="1"> <thead> <tr> <th>Configuration</th> <th>Formula for frequency reference</th> </tr> </thead> <tbody> <tr> <td>0</td> <td>$M+(G \cdot A)$ Main reference + (BAS-03 x BAS-01 x IN-01)</td> </tr> <tr> <td>1</td> <td>$M \cdot (G \cdot A)$ Main reference x (BAS-03 x BAS-01)</td> </tr> <tr> <td>2</td> <td>$M / (G \cdot A)$ Main reference / (BAS-03 x BAS-01)</td> </tr> <tr> <td>3</td> <td>$M + \{M \cdot (G \cdot A)\}$ Main reference + (Main reference x [BAS-03 x BAS-01])</td> </tr> <tr> <td>4</td> <td>$M + G \cdot 2 \cdot (A - 50)$ Main reference + BAS-03 x 2 x (BAS-01-50) x IN-01</td> </tr> <tr> <td>5</td> <td>$M \cdot \{G \cdot 2 \cdot (A - 50)\}$ Main reference x (BAS-03 x 2 x [BAS-01-50])</td> </tr> <tr> <td>6</td> <td>$M / \{G \cdot 2 \cdot (A - 50)\}$ Main reference / (BAS-03 x 2 x [BAS-01-50])</td> </tr> <tr> <td>7</td> <td>$M + M \cdot G \cdot 2 \cdot (A - 50)$ Main reference + Main reference x BAS-03 x 2 x (BAS-01-50)</td> </tr> </tbody> </table> <p>M: Main frequency reference (Hz or rpm) G: Auxiliary reference gain (%) A: Auxiliary frequency reference (Hz or rpm) or gain (%)</p> <p>Note</p> <p>When the maximum frequency value is high, output frequency deviation may occur due to analog input variation and deviations in the calculations.</p>	Configuration	Formula for frequency reference	0	$M+(G \cdot A)$ Main reference + (BAS-03 x BAS-01 x IN-01)	1	$M \cdot (G \cdot A)$ Main reference x (BAS-03 x BAS-01)	2	$M / (G \cdot A)$ Main reference / (BAS-03 x BAS-01)	3	$M + \{M \cdot (G \cdot A)\}$ Main reference + (Main reference x [BAS-03 x BAS-01])	4	$M + G \cdot 2 \cdot (A - 50)$ Main reference + BAS-03 x 2 x (BAS-01-50) x IN-01	5	$M \cdot \{G \cdot 2 \cdot (A - 50)\}$ Main reference x (BAS-03 x 2 x [BAS-01-50])	6	$M / \{G \cdot 2 \cdot (A - 50)\}$ Main reference / (BAS-03 x 2 x [BAS-01-50])	7	$M + M \cdot G \cdot 2 \cdot (A - 50)$ Main reference + Main reference x BAS-03 x 2 x (BAS-01-50)
Configuration	Formula for frequency reference																		
0	$M+(G \cdot A)$ Main reference + (BAS-03 x BAS-01 x IN-01)																		
1	$M \cdot (G \cdot A)$ Main reference x (BAS-03 x BAS-01)																		
2	$M / (G \cdot A)$ Main reference / (BAS-03 x BAS-01)																		
3	$M + \{M \cdot (G \cdot A)\}$ Main reference + (Main reference x [BAS-03 x BAS-01])																		
4	$M + G \cdot 2 \cdot (A - 50)$ Main reference + BAS-03 x 2 x (BAS-01-50) x IN-01																		
5	$M \cdot \{G \cdot 2 \cdot (A - 50)\}$ Main reference x (BAS-03 x 2 x [BAS-01-50])																		
6	$M / \{G \cdot 2 \cdot (A - 50)\}$ Main reference / (BAS-03 x 2 x [BAS-01-50])																		
7	$M + M \cdot G \cdot 2 \cdot (A - 50)$ Main reference + Main reference x BAS-03 x 2 x (BAS-01-50)																		
BAS-03 Aux Ref Gain	Adjusts the size of the input (BAS-01 Aux Ref Src) configured for the auxiliary frequency.																		
IN-65–75 Px Define	Set one of the multi-function input terminals to “40 (dis Aux Ref)” and turn it on to disable the auxiliary frequency reference. The inverter will operate using the main frequency reference only.																		

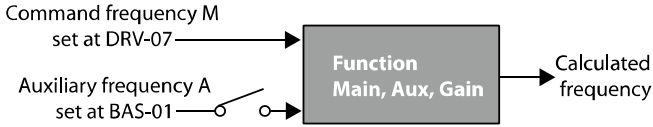

The auxiliary command frequency is turned off when the terminal input (Px) set to “40 (dis Aux Ref)” is on.

Auxiliary Reference Operation Ex #1

Keypad Frequency Setting is Main Frequency, and V1 Analog Voltage is Auxiliary Frequency

- Main frequency (DRV-07): Keypad (operation frequency 30 Hz)
- Maximum frequency setting (DRV-20): 400 Hz
- Auxiliary frequency setting (BAS-01): V1 [Display by percentage (%) or auxiliary frequency (Hz) depending on the operation setting condition]
- Auxiliary reference gain setting (BAS-03): 50%
- IN-01–32: Factory default

Example: An input voltage of 6 V is supplied to V1, and the frequency corresponding to 10 V is 60 Hz. The table below shows the auxiliary frequency A as 36 Hz [=60 Hz X (6 V/10 V)] or 60% [= 100% X (6 V/10 V)].

Setting *	Calculating final command frequency**
0 $M[\text{Hz}] + (G[\%] * A[\text{Hz}])$	$30 \text{ Hz}(M) + (50\%(G) \times 36 \text{ Hz}(A)) = 48 \text{ Hz}$
1 $M[\text{Hz}] * (G[\%] * A[\%])$	$30 \text{ Hz}(M) \times (50\%(G) \times 60\%(A)) = 9 \text{ Hz}$
2 $M[\text{Hz}] / (G[\%] * A[\%])$	$30 \text{ Hz}(M) / (50\%(G) \times 60\%(A)) = 100 \text{ Hz}$
3 $M[\text{Hz}] + \{M[\text{Hz}] * (G[\%] * A[\%])\}$	$30 \text{ Hz}(M) + \{30[\text{Hz}] \times (50\%(G) \times 60\%(A))\} = 39 \text{ Hz}$
4 $M[\text{Hz}] + G[\%] * 2 * (A[\%] - 50[\%]) [\text{Hz}]$	$30 \text{ Hz}(M) + 50\%(G) \times 2 \times (60\%(A) - 50\%) \times 60 \text{ Hz} = 36 \text{ Hz}$
5 $M[\text{Hz}] * \{G[\%] * 2 * (A[\%] - 50[\%])\}$	$30 \text{ Hz}(M) \times \{50\%(G) \times 2 \times (60\%(A) - 50\%)\} = 3 \text{ Hz}$
6 $M[\text{Hz}] / \{G[\%] * 2 * (A[\%] - 50[\%])\}$	$30 \text{ Hz}(M) / \{50\%(G) \times 2 \times (60\% - 50\%)\} = 300 \text{ Hz}$
7 $M[\text{Hz}] + M[\text{Hz}] * G[\%] * 2 * (A[\%] - 50[\%])$	$30 \text{ Hz}(M) + 30 \text{ Hz}(M) \times 50\%(G) \times 2 \times (60\%(A) - 50\%) = 33 \text{ Hz}$

* M: Main frequency reference (Hz or rpm)/G: Auxiliary reference gain (%)/A: Auxiliary frequency reference (Hz or rpm) or gain (%).

** If the frequency setting is changed to rpm, it is converted to rpm instead of Hz.

Auxiliary Reference Operation Ex #2

The Keypad Frequency Setting is the Main Frequency, and I2 Analog Voltage is the Auxiliary Frequency

- Main frequency (DRV-07): Keypad (Operation frequency 30 Hz)
- Maximum frequency setting (BAS-20): 400 Hz
- Auxiliary frequency setting (BAS-01): I1 [Display by percentage (%) or auxiliary frequency (Hz) depending on the operation setting condition]
- Auxiliary reference gain setting (BAS-03): 50%
- IN-01–32: Factory default

Example: An input current of 10.4 mA is applied to I1, with the frequency corresponding to 20 mA of 60 Hz. The table below shows auxiliary frequency A as 24 Hz [=60[Hz] X {(10.4[mA]-4[mA])/(20[mA] - 4[mA])}] or 40% [=100[%] X {(10.4[mA] - 4[mA])/(20[mA] - 4[mA])}].

Setting*	Calculating final command frequency**
0 M[Hz]+(G[%]*A[Hz])	30 Hz(M)+(50%(G)x24 Hz(A))=42 Hz
1 M[Hz]*(G[%]*A[%])	30 Hz(M)x(50%(G)x40%(A))=6 Hz
2 M[Hz]/(G[%]*A[%])	30 Hz(M)/(50%(G)x40%(A))=150 Hz
3 M[Hz]+{M[Hz]*(G[%]*A[%])}	30 Hz(M)+{30[Hz]x(50%(G)x40%(A))}=36 Hz
4 M[Hz]+G[%]*2*(A[%]-50[%])[Hz]	30 Hz(M)+50%(G)x2x(40%(A)-50%)x60 Hz=24 Hz
5 M[Hz]*{G[%]*2*(A[%]-50[%])}	30 Hz(M)x{50%(G)x2x(40%(A)-50%)=-3 Hz (Reverse)
6 M[Hz]/{G[%]*2*(A[%]-50[%])}	30 Hz(M)/{50%(G)x2x(60%-40%)=-300 Hz (Reverse)
7 M[Hz]+M[Hz]*G[%]*2*(A[%]-50[%])	30 Hz(M)+30 Hz(M)x50%(G)x2x (40%(A)-50%)=27 Hz

*M: Main frequency reference (Hz or rpm)/G: Auxiliary reference gain (%)/A: Auxiliary frequency reference Hz or rpm) or gain (%).

** If the frequency setting is changed to rpm, it is converted to rpm instead of Hz.

Auxiliary Reference Operation Ex #3

V1 is the Main Frequency, and I1 is the Auxiliary Frequency

- Main frequency (DRV-07): V1 (frequency command setting to 5 V and is set to 30 Hz)
- Maximum frequency setting (DRV-20): 400 Hz
- Auxiliary frequency (BAS-01): I1 [Display by percentage (%) or auxiliary frequency (Hz) depending on the operation setting condition]
- Auxiliary reference gain (BAS-03): 50%
- IN-01-32: Factory default

Example: An input current of 10.4 mA is applied to I1, with the frequency corresponding to 20 mA of 60 Hz. The table below shows auxiliary frequency A as 24 Hz [=60[Hz]x{(10.4[mA]-4[mA])/(20[mA]-4[mA])}] or 40% [=100[%] x {(10.4[mA] - 4[mA]) / (20 [mA] - 4[mA])}].

Setting*	Calculating final command frequency**
0	$M[\text{Hz}] + (G[\%] * A[\text{Hz}])$ 30 Hz(M)+(50%(G)x24 Hz(A))=42 Hz
1	$M[\text{Hz}] * (G[\%] * A[\%])$ 30 Hz(M)x(50%(G)x40%(A))=6 Hz
2	$M[\text{Hz}] / (G[\%] * A[\%])$ 30 Hz(M)/(50%(G)x40%(A))=150 Hz
3	$M[\text{Hz}] + \{M[\text{Hz}] * (G[\%] * A[\%])\}$ 30 Hz(M)+{30[Hz]x(50%(G)x40%(A))}=36 Hz
4	$M[\text{Hz}] + G[\%] * 2 * (A[\%] - 50[\%]) [\text{Hz}]$ 30 Hz(M)+50%(G)x2x(40%(A)-50%)x60 Hz=24 Hz
5	$M[\text{Hz}] * \{G[\%] * 2 * (A[\%] - 50[\%])\}$ 30 Hz(M)x{50%(G)x2x(40%(A)-50%)=-3 Hz (Reverse)
6	$M[\text{Hz}] / \{G[\%] * 2 * (A[\%] - 50[\%])\}$ 30 Hz(M){50%(G)x2x(60%-40%)=-300 Hz(Reverse)
7	$M[\text{Hz}] + M[\text{Hz}] * G[\%] * 2 * (A[\%] - 50[\%])$ 30 Hz(M)+30 Hz(M)x50%(G)x2x(40%(A)-50%)=27 Hz

*M: Main frequency reference (Hz or rpm)/G: Auxiliary reference gain (%)/A: Auxiliary frequency reference (Hz or rpm) or gain (%).

**If the frequency setting is changed to rpm, it is converted to rpm instead of Hz.

Note

When the maximum frequency value is high, output frequency deviation may occur due to analog input variation and deviations in the calculations.

8.2 Jog Operation

The jog operation allows for temporary control of the inverter. You can enter a jog operation command using the multi-function terminals.

The jog operation is the second-highest priority operation, after the dwell operation. If a jog operation is requested while operating the multi-step, up-down, or 3-wire operation modes, the jog operation overrides all other operation modes.

8.2.1 Jog Operation 1-Forward Jog via Multi-function Terminal

The jog operation is available using the multi-function terminal input. To start a forward jog operation, an Fx operation command must be entered. The table below lists parameter settings for a forward jog operation using the multi-function terminal input.

Group	Code	Name	LCD Display	Parameter Setting		Setting Range	Unit
DRV	11	Jog frequency	JOG Frequency	10.00		0.5– Max Freq	Hz
	12	Jog operation acceleration time	JOG Acc Time	20.00		0.00–600.00	sec
	13	Jog operation deceleration time	JOG Dec Time	30.00		0.00–600.00	sec
IN	65–75	Px terminal configuration	Px Define(Px: P1–P8 [optional: P9–P11])	6	JOG	-	-

Forward Jog Details

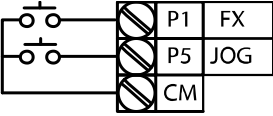
Code	Description
IN-65–75 Px Define	<p>Select an input terminal from IN-65–75 (P1–P8 [optional: P9–P11]) and set it to "6 (jog)".</p>  <p>[Terminal settings for jog operation using the P5 terminal]</p>
DRV-11 JOG Frequency	Sets the operation frequency.

Code	Description
DRV-12 JOG Acc Time	Sets the acceleration speed for a jog operation.
DRV-13 JOG Dec Time	Sets the deceleration speed for a jog operation.

If a signal is entered at the jog terminal while an Fx operation command is on, the operation frequency changes to the jog frequency and the jog operation begins.

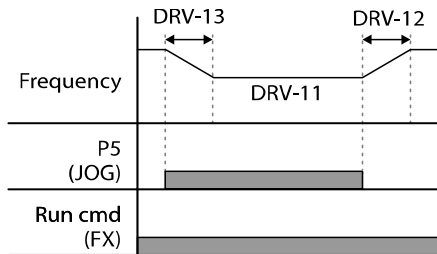

8.2.2 Jog Operation 2-Forward/Reverse Jog via Multi-function Terminal

For jog operation 1, an operation command must be entered to start an operation, but while using jog operation 2, a terminal that is set for a forward or reverse jog also starts an operation.

The priorities for the frequency, acc/dec time and terminal block input during operation in relation to other operating modes (Dwell, 3-wire, up/down, etc.) are identical to jog operation 1. If a different operation command is entered during a jog operation, it is ignored and the operation maintains the jog frequency.

Group	Code	Name	LCD Display	Parameter setting		Setting Range	Unit
DRV	11	Jog frequency	JOG Frequency	10.00		0.5–Max Freq	Hz
	12	Jog operation acceleration time	JOG Acc Time	20.00		0.00–600.00	sec
	13	Operation deceleration time	JOG Dec Time	30.00		0.00–600.00	sec
IN	65–75	Px terminal configuration	Px Define (Px: P1–P8 [optional: P9–P11])	46	FWD JOG	-	-
				47	REV JOG		

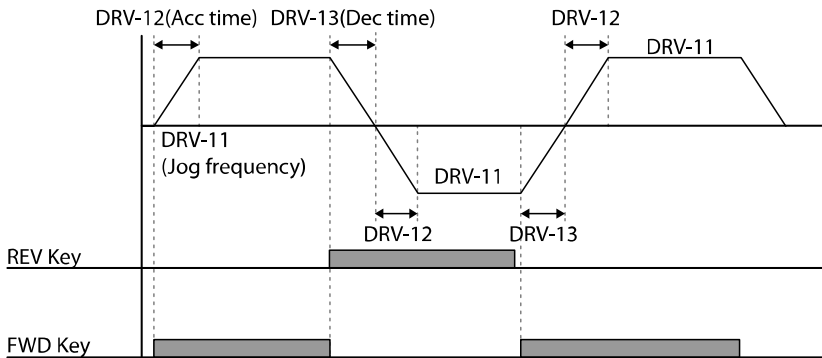

8.2.3 Jog Operation via Keypad Input

The jog operation is available using the keypad input as well.

The priorities for the frequency, acc/dec time, and terminal block input during an operation in relation to other operating modes (Dwell, 3-wire, up/down, etc.) are identical to jog operations using the terminal input.

Group	Code	Name	LCD Display	Parameter setting	Setting Range	Unit
DRV	11	Jog frequency	JOG Frequency	10.00	0.5–Max Freq	Hz
	12	Jog operation acceleration time	JOG Acc Time	20.00	0.00–600.00	sec
	13	Operation deceleration time	JOG Dec Time	30.00	0.00–600.00	sec

The table below lists parameter settings for a forward jog operation using the keypad input.

MODE	Group	Code	LCD Display	Parameter Setting	Setting Range	Unit
CNF	-	42	Multi-Key Sel	1 JOG Key	-	-
PAR	DRV	06	Cmd Source	0 Keypad	0–5	sec

After setting CNF-42 to “1 (JOG Key)” and DRV-06 (in PAR mode) to “0 (Keypad)”, you can start the jog operation using the keypad by pressing the [MULTI] key on the keypad.

When you press the [MULTI] key, "J" is displayed on the keypad indicating that a jog operation via the keypad is available. Press and hold the [FWD] or [REV] key to perform forward or reverse jog operations. Jog operations stop when you lift your finger from the [FWD] or [REV] key on the keypad.

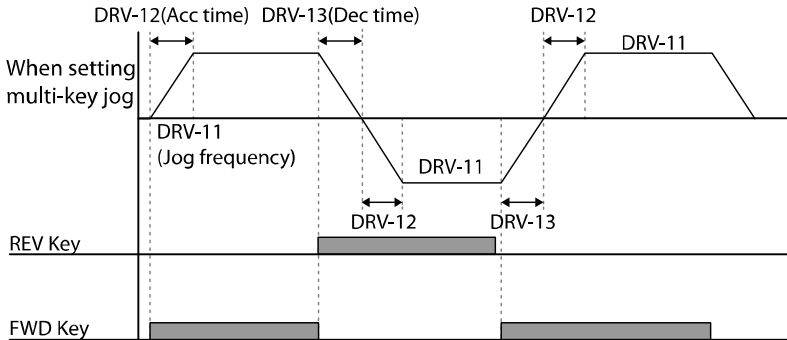

8.3 Up/down Operation

The acc/dec time can be controlled via the input at the multi-function terminal block. The up-down operation can be applied easily to a system that uses the upper-lower limit switch signals (such as those of a flow meter) for acc/dec commands.

Group	Code	Name	LCD Display	Parameter Setting		Setting Range	Unit
ADV	65	Up/down operation frequency save	U/D Save Mode	1	Yes	0-1	-
	85	Up/down mode Sel	U/D Mode Sel	0	U/D Normal	0:U/D Normal 1:U/D Step 2:U/D Step+Norm	-
	86	Up/down Step frequency	U/D Step Freq	-	0	0-maximum frequency	Hz
IN	65-75	Px terminal configuration	Px Define (Px: P1-P8 [optional: P9-P11])	17	Up	0-51	-
				18	Down		
				19	U/D Save		
				20	U/D Clear		

Up/down Operation Setting Details

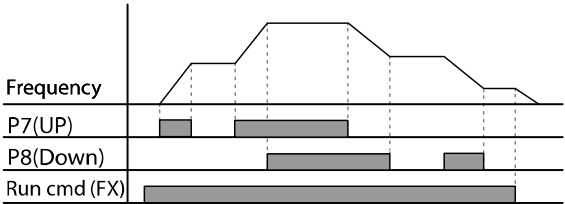
Code	Description															
IN-65-75 Px Define	<p>Select two terminals for up/down operation and set them to "19 (Up)" and "20 (Down)", respectively. With the operation command input, acceleration begins when the Up terminal signal is on. Acceleration stops and constant speed operation begins when the signal is off.</p> <p>During operation, deceleration begins when the Down signal is on. Deceleration stops and a constant speed operation begins when both the Up and Down signals are entered at the same time.</p> 															
ADV-65 U/D Save Mode	<p>During a constant speed operation, the operating frequency is saved automatically under the following conditions: The operation command (Fx or Rx) is off, a fault trip occurs, or the power is off.</p> <p>You can also save the up/down operation frequency while the inverter is operated at a constant speed by setting one of the multi-function terminals (IN-65-75) to "19 (U/D Save)", or by setting ADV-65 to "1 (Yes)". If the up/down frequency saving function is enabled for the terminal and keypad inputs, the operation frequency will be saved as described in the following table:</p> <table border="1" data-bbox="333 1066 980 1257"> <thead> <tr> <th>Save by keypad input (ADV-65) set to "1 (Yes)"</th> <th>Save by keypad input (IN-65-75) set to "19 (U/D Save)"</th> <th>U/D Save Result</th> </tr> </thead> <tbody> <tr> <td>X</td> <td>X</td> <td>X</td> </tr> <tr> <td>O</td> <td>X</td> <td>O</td> </tr> <tr> <td>X</td> <td>O</td> <td>O</td> </tr> <tr> <td>O</td> <td>O</td> <td>O</td> </tr> </tbody> </table>	Save by keypad input (ADV-65) set to "1 (Yes)"	Save by keypad input (IN-65-75) set to "19 (U/D Save)"	U/D Save Result	X	X	X	O	X	O	X	O	O	O	O	O
Save by keypad input (ADV-65) set to "1 (Yes)"	Save by keypad input (IN-65-75) set to "19 (U/D Save)"	U/D Save Result														
X	X	X														
O	X	O														
X	O	O														
O	O	O														

Code	Description									
	ADV-65 U/D Save Mode: Yes									
	ADV-65 U/D Save Mode: No									
ADV-85 U/D Mode Sel	<p>When the operation command is turned on again, or when the inverter regains the power source or resumes to a normal operation from a fault trip, it resumes operation at the saved frequency.</p> <p>To delete the saved frequency, use the multi-function terminal block. Set one of the multi-function terminals to "20 (U/D Clear)" and apply signals to it during a constant speed operation. The saved frequency and the up/down operation configuration will be deleted.</p>									
	<table border="1"> <thead> <tr> <th data-bbox="341 1212 375 1252">Configuration</th> <th data-bbox="375 1212 532 1252"></th> <th data-bbox="532 1212 980 1252">Description</th> </tr> </thead> <tbody> <tr> <td data-bbox="341 1252 375 1332">0</td> <td data-bbox="375 1252 532 1332">U/D Normal</td> <td data-bbox="532 1252 980 1332">Targeted Frequency increase or decrease based on Max/Min Frequency</td> </tr> <tr> <td data-bbox="341 1332 375 1380">1</td> <td data-bbox="375 1332 532 1380">U/D Step</td> <td data-bbox="532 1332 980 1380">According to Edge input of up/down port,</td> </tr> </tbody> </table>		Configuration		Description	0	U/D Normal	Targeted Frequency increase or decrease based on Max/Min Frequency	1	U/D Step
Configuration		Description								
0	U/D Normal	Targeted Frequency increase or decrease based on Max/Min Frequency								
1	U/D Step	According to Edge input of up/down port,								

Code	Description
	Frequency will be increase or decrease as much as ADV-86 setting date.
2	U/D Step+Norm Frequency that will be set by Edge input.

1 : U/D STEP

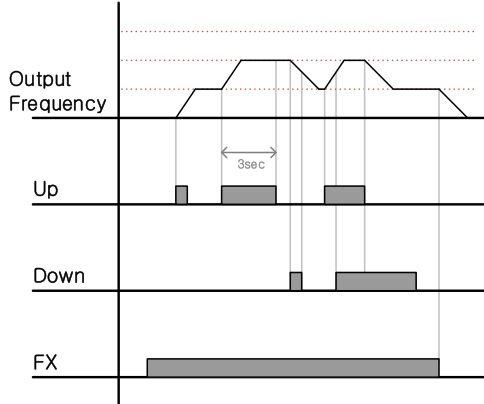

2 : U/D STEP+Norm

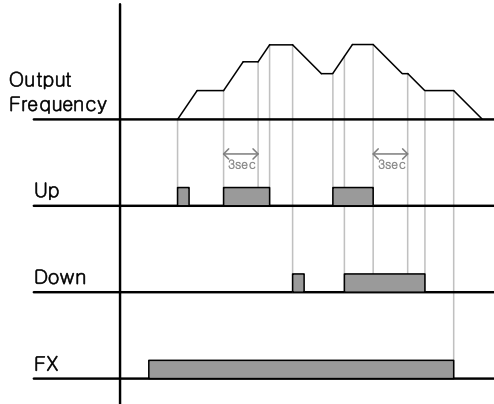

8.4 3-Wire Operation

The 3-wire operation latches the signal input (the signal stays on after the button is released), and is used when operating the inverter with a push button.

Group	Code	Name	LCD Display	Parameter Setting	Setting Range	Unit
DRV	06	Command source	Cmd Source	1	Fx/Rx - 1	0-5
IN	65-75	Px terminal configuration	Px Define(Px: P1-P8 [optional: P9-P11])	14	3-Wire	0-51

To enable the 3-wire operation, the following circuit sequence is necessary. The minimum input time (t) for 3-wire operation is 1 ms, and the operation stops when both the forward and reverse operation commands are entered at the same time.

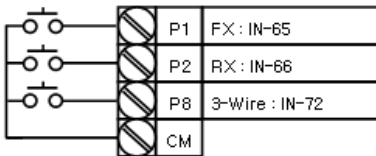

[Terminal connections for 3-wire operation]

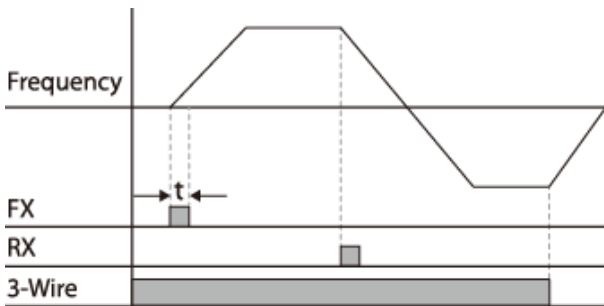

[3-wire operation]

8.5 Safe Operation Mode

When the multi-function terminals are configured to operate in Safe mode, operation commands can be entered in Safe mode only. Safe mode is used to safely control the inverter through the multi-function terminals.

Group	Code	Name	LCD Display	Parameter Setting		Setting Range	Unit
ADV	70	Safe operation selection	Run En Mode	1	DI Dependent	Always Enable / DI Dependent	-
	71	Safe operation stop mode	Run Dis Stop	0	Free-Run	0-2	-
	72	Safe operation deceleration time	Q-Stop Time	5.0		0.0-600.0	sec
IN	65-75	Px terminal configuration	Px Define(Px: P1-P8 [optional: P9-P11])	13	RUN Enable	0-51	-

Safe Operation Mode Setting Details

Code	Description							
IN-65-75 Px Define	From the multi-function terminals, select a terminal to operate in Safe mode and set it to "13 (RUN Enable)".							
ADV-70 Run En Mode	<table border="1"> <thead> <tr> <th>Setting</th> <th>Function</th> </tr> </thead> <tbody> <tr> <td>0 Always Enable</td> <td>Safe operation mode is deactivated.</td> </tr> <tr> <td>1 DI Dependent</td> <td>Recognizes the operation command from a multi-function input terminal.</td> </tr> </tbody> </table>		Setting	Function	0 Always Enable	Safe operation mode is deactivated.	1 DI Dependent	Recognizes the operation command from a multi-function input terminal.
	Setting	Function						
	0 Always Enable	Safe operation mode is deactivated.						
1 DI Dependent	Recognizes the operation command from a multi-function input terminal.							
ADV-71 Run Dis Stop	Set the operation of the inverter when the multi-function input terminal configured for Safe mode is off. When the Safe mode signal is given, the inverter decelerates according to the settings at the Q-Stop time. The inverter decelerates and stops according to the deceleration time (Dec Time) settings if the run command is off.							
	<table border="1"> <thead> <tr> <th>Setting</th> <th>Function</th> </tr> </thead> <tbody> <tr> <td>1 Free-Run</td> <td>Blocks the inverter output when the multi-function terminal is off.</td> </tr> <tr> <td>2 Q-Stop</td> <td>The deceleration time (Q-Stop Time) used in Safe mode. It stops after deceleration and then the operation can resume only when the operation command is entered again. The operation will not</td> </tr> </tbody> </table>		Setting	Function	1 Free-Run	Blocks the inverter output when the multi-function terminal is off.	2 Q-Stop	The deceleration time (Q-Stop Time) used in Safe mode. It stops after deceleration and then the operation can resume only when the operation command is entered again. The operation will not
	Setting	Function						
1 Free-Run	Blocks the inverter output when the multi-function terminal is off.							
2 Q-Stop	The deceleration time (Q-Stop Time) used in Safe mode. It stops after deceleration and then the operation can resume only when the operation command is entered again. The operation will not							

Code	Description
	begin if only the multi-function terminal is on.
3	Q-Stop Resume The inverter decelerates to the deceleration time (Q-Stop Time) in Safe operation mode. It stops after deceleration. Then, if the multi-function terminal is on, the operation resumes as soon as the operation command is entered.
ADV-72 Q-Stop Time	Set the deceleration time when ADV-71 (Run Dis Stop) is set to "1 (Q-Stop)" or "2 (Q-Stop Resume)".

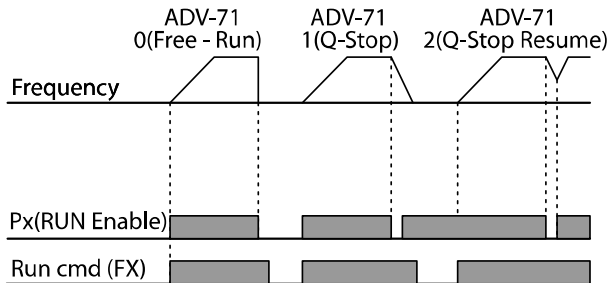

8.6 Dwell Operation

When DRV-09 (Control mode) is set to "0 (V/F mode)", a dwell operation may be used to maintain torque during inverter application, such as when enough torque is required before releasing mechanical brakes on lift-type loads. A dwell operation is based on the acc/dec dwell frequency and the dwell time set by the user. The following conditions also affect dwell operations.

- Acceleration Dwell Operation:** When an operation command is given, acceleration continues until the acceleration dwell frequency and constant speed is reached within the acceleration dwell operation time (Acc Dwell Time). After the Acc Dwell Time has passed, acceleration is carried out based on the set acceleration time and operation speed.
- Deceleration Dwell Operation:** When a stop command is given, deceleration continues until the deceleration dwell frequency and constant speed are reached within the deceleration dwell operation time (Dec Dwell Freq). After the set time has passed, deceleration is carried out based on the set deceleration time, and then the operation stops.

Group	Code	Name	LCD Display	Parameter Setting	Setting Range	Unit
ADV	20	Dwell frequency during acceleration	Acc Dwell Freq	5.00	Start frequency – Maximum frequency	Hz
	21	Operation time during acceleration	Acc Dwell Time	0.0	0.0–60.0	sec
	22	Dwell frequency during deceleration	Dec Dwell Freq	5.00	Start frequency – Maximum frequency	Hz
	23	Operation time during deceleration	Dec Dwell Time	0.0	0.0– 60.0	sec

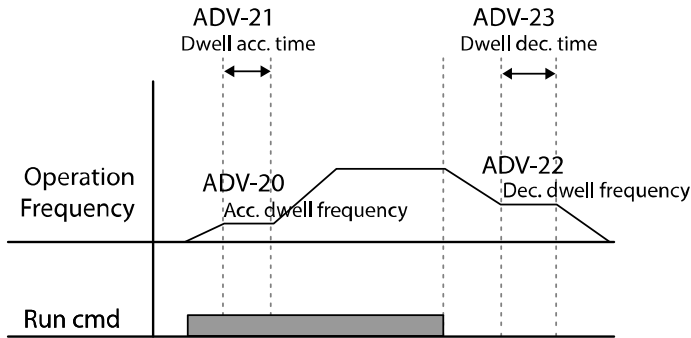

Note

Dwell operations are not performed when:

- The dwell operation time is set to 0 sec or the dwell frequency is set to 0 Hz.
- Re-acceleration is attempted from a stop or during deceleration, since only the first acceleration dwell operation command is valid.

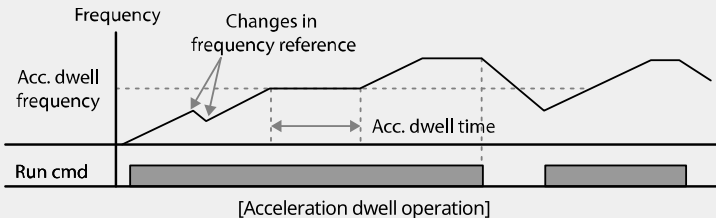

- Although a deceleration dwell operation is carried out whenever stop commands are entered and the deceleration dwell frequency is passed through, it does not work during a deceleration operation by a simple frequency change (which is not deceleration due to a stop operation), or during external brake control applications.

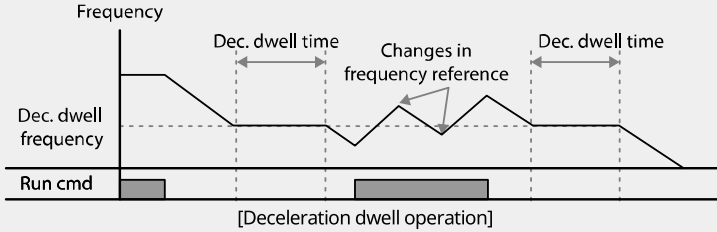

8.7 Slip Compensation Operation

Slip refers to the variation between the setting frequency (synchronous speed) and motor rotation speed. As the load increases, there can be variations between the setting frequency and motor rotation speed. Slip compensation is used for loads that require compensation of these speed variations.*

Motor Rotation

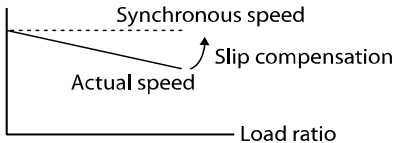

*If DRV-09 is set to Sensorless, Vector, or V/F PG, the variation (slip) is automatically compensated.

Group	Code	Name	LCD Display	Parameter Setting	Setting Range	Unit
DRV	09	Control mode	Control Mode	2 Slip Compen	0-5	-
	14	Motor Capacity	Motor Capacity	2 0.75 kW (0.75 kW based)	0.2-450	kW
BAS	11	Number of motor poles	Pole Number	4	2-48	-
	12	Rated slip speed	Rated Slip	90 (0.75 kW based)	0-3000	rpm
	13	Rated motor	Rated Curr	3.6 (0.75 kW based)	1-10000	A

Group	Code	Name	LCD Display	Parameter Setting	Setting Range	Unit
		current				
	14	Motor no-load current	Noload Curr	1.6 (0.75 kW based)	0.5–1000	A
	16	Motor efficiency	Efficiency	72 (0.75 kW based)	70–100	%
	17	Load Inertia ratio	Inertia Rate	0 (0.75 kW based)	0–8	-
ADV	92	SlipGain Mot-H	SlipGain Mot-H	50	0-200	%
	93	SlipGain Gen-H	SlipGain Gen-H	50	0-200	%
	94	SlipGain Mot-L	SlipGain Mot-L	50	0-200	%
	95	SlipGain Gen-L	SlipGain Gen-L	50	0-200	%
	96	Slip Filter	Slip Filter	300	0-10000	msec
	97	Slip Comp Freq	Slip Comp Freq	5.00	0-60.00	Hz
	98	Slip Gain Freq	Slip Gain Freq	9.00	0-20.00	Hz

Slip Compensation Operation–Setting Details

Code	Description
DRV-09 Control Mode	Sets DRV-09 to “2 (Slip Compen)” to carry out the slip compensation operation.
DRV-14 Motor Capacity	Sets the capacity of the motor connected to the inverter.
BAS-11 Pole Number	Enters the number of poles from the motor rating plate.
BAS-12 Rated Slip	Enters the number of rated rotations from the motor rating plate.
BAS-13 Rated Curr	Enters the rated current from the motor rating plate.
BAS-14 Noload Curr	Enters the measured current when the load on the motor axis is removed and when the motor is operated at the rated frequency. If the no-load current is difficult to measure, enter a current equivalent to 30-50% of the rated motor current.
BAS-16 Efficiency	Enters the efficiency from the motor rating place.
BAS-17 Inertia Rate	If inertia rate < 10 x motor inertia, set BAS-16 to “0”. If inertia rate = 10 x motor inertia, set BAS-16 to “1”. If inertia rate > 10 x motor inertia, set BAS-16 to “2–8”.
ADV-92 Slip Gain Mot-H ADV-93 Slip Gain Gen-H	This is the slip compensation gain used in the region where the output frequency is higher than the slip compensation gain switching frequency (ADV-98). You can set the gain values differently for the

Learning Advanced Features

Code	Description
	reverse/regeneration operations.
ADV-94 Slip Gain Mot-L ADV-95 Slip Gain Gen-L	This is the slip compensation gain used in the region where the output frequency is lower than the slip compensation gain switching frequency (ADV-98). You can set the gain values differently for the reverse/regeneration operations.
ADV-96 Slip Filter	The filter time constant used when calculating the current required for slip compensation.
ADV-97 Slip Comp Freq	<p>You can set the frequency at which slip compensation starts. It is used when load compensation is not performed properly due to a low load compensation amount when stopped.</p> <p>At a constant speed, when it is above this frequency setting value, it calculates the real time slip to compensate the load. If it is below, it compensates the load by using the previously calculated slip. When accelerating, the load is compensated by carrying out the sleep operation regardless of this frequency value. When decelerated, the load is compensated by using the previous calculated slip regardless of this frequency.</p> <p>When this value is set to 0, the slip operation is compensated in real time at all frequencies regardless of acceleration/deceleration and constant speed</p>
ADV-98 Slip Gain Freq	Input using the rated speed of the motor nameplate

Note

The following is a formula for calculating the rated slip:

$$f_s = \frac{f_r \times 120}{P} - Rpm$$

f_s = Rated slip frequency, f_r = Rated frequency

Rpm = Number of rated motor rotations, P = Number of motor poles

Ex.) If the rated frequency is 60 Hz, the rated revolution is 1740 rpm, and the pole number is 4:

$$f_s = \frac{60 \times 120}{4} - 1740 = 60rpm$$

8.8 PID Control

PID control is one of the most common auto-control methods. It uses a combination of proportional, integral, and differential (PID) controls that provide more effective control for automated systems. The functions of PID control that can be applied to the inverter operation are as follows:

Purpose	Function
Speed Control	Controls the speed by monitoring the current speed levels of the equipment or machinery being controlled. This control maintains a consistent speed or operates at the target speed.
Pressure Control	Controls the pressure by monitoring the current pressure levels of the equipment or machinery being controlled. This control maintains a consistent pressure or operates at the target pressure.
Flow Control	Controls the flow by monitoring the current amount of flow in the equipment or machinery being controlled. This control maintains a consistent flow or operates at a target flow.
Temperature Control	Controls the temperature by monitoring the current temperature levels of the equipment or machinery being controlled. This control maintains a consistent temperature or operates at the target temperature.

8.8.1 PID Basic Operation

PID operates by controlling the output frequency of the inverter, through automated system process control to maintain the speed, pressure, flow, temperature, or tension.

Group	Code	Name	LCD Display	Parameter Setting	Setting Range	Unit
APP	01	Application mode	App Mode	2 Proc PID	0-4	-
	16	PID output monitor	PID Output	-	-	-
	17	PID reference monitor	PID Ref Value	-	-	-
	18	PID Feedback Value	PID Fdb Value	-	-	-
	19	PID reference setting	PID Ref Set	50.00	-100-100	%

Learning Advanced Features

Group	Code	Name	LCD Display	Parameter Setting		Setting Range	Unit
	20	PID reference source	PID Ref Source	0	Keypad	0-10	-
	21	PID feedback source	PID F/B source	0	V1	0-9	-
	22	PID proportional gain	PID P-Gain	-	50.0	0-1000	%
	23	PID integral time	PID I-Time	-	10.0	0-200.0	sec
	24	PID differential time	PID D-Time	-	0	0-1000	ms
	25	PID feed forward gain	PID F-Gain	-	0.0	0-1000	%
	26	PID proportional gain scale	P Gain Scale	-	100.0	0-100	%
	27	PID output filter	PID Out LPF	-	0	0-10000	ms
	28	PID mode options	PID Mode	0	0 Process PID	0-1	-
	29	PID output upper limit	PID Limit Hi	-	60.00	APP-30 setting value-300	Hz
	30	PID output lower limit	PID Limit Lo	-	-60.00	-300-APP-029 setting value	Hz
	31	PID output inversion	PID Out Inv	-	0 No	0-1	-
	32	PID output scale	PID Out Scale	-	100.0	0.1-1000	%
	34	Pre-PID start frequency	Pre-PID Freq	-	0.00	0-Max. Freq	Hz
	35	Feedback value to end Pre-PID operation	Pre-PID Exit	-	0.0	0-100	%
	36	Pre-PID delay time	Pre-PID Delay	-	600	0-9999	sec
	37	PID sleep delay time	PID Sleep DT	-	60.0	0-999.9	sec
	38	PID sleep frequency	PID Sleep Freq	-	0.00	0-Max. Freq.	Hz
	39	PID wakeup level	PID WakeUp	-	35	0-100	%

Group	Code	Name	LCD Display	Parameter Setting	Setting Range	Unit	
			Lev				
	40	PID wakeup mode option	PID WakeUp Mod	0	Below Level	0-2	-
	41	PID Rev Run Enable	PID Rev Run En	0	No	0-1	-
	42	PID unit option	PID Unit Sel	0	Hz	0-12	-
	43	PID gain unit	PID Unit Gain	-	100.0	0-300	%
	44	PID scale unit	PID Unit Scale	2	X 1	0-2	-
	45	PID proportional gain 2	PID P2-Gain	-	100.0	0-1000	%
IN	65-75	Px circuit function setting	Px Define (Px: P1-P8 [optional: P9-P11])	22	I-Term Clear	0-51	-
				23	PID Openloop		
				24	P Gain2		

Note

- Normal PID output (PID OUT) is bipolar and is limited by APP-29 (PID Limit Hi) and APP-30 (PID Limit Lo) settings.
- If a PID change operation (changes from PID operation to normal operation) comes into multi-function inputs (P1-P11), the value of [%] is converted to [Hz] and is output.
- DRV-20 (MaxFreq) value equals 100% of PID output.

PID Basic Operation Setting Details

Code	Description
APP-01 App Mode	Sets the code to "2 (Proc PID)" to enable process PID.
APP-16 PID Output	Displays the existing output value of the PID controller. The unit, gain, and scale set at APP-42, APP-43, and APP-44 are applied on the display.
APP-17 PID Ref Value	Displays the existing reference value set for the PID controller. The unit, gain, and scale set at APP-42, APP-43, and APP-44 are applied on the display.
APP-18 PID Fdb Value	Displays the latest feedback value of the PID controller. The unit, gain, and scale set at APP-42, APP-43, and APP-44 are applied on the display.
APP-19 PID Ref Set	Sets the reference value when APP-20 (PID Ref Source) is set to "0 (Keypad)". If the reference source is set to any input other than the

Code	Description																																				
APP-20 PID Ref Source	keypad, this value will be ignored.																																				
	Set the reference input source for the PID control. If the V1 terminal is set as the PID feedback source at APP-21 (PID F/B Source), it cannot be set as the PID reference source. To set V1 as a reference source, change the feedback source settings first.																																				
	<table border="1"> <thead> <tr> <th data-bbox="351 421 490 464">Setting</th> <th data-bbox="493 421 874 464">Function</th> <th data-bbox="878 421 972 464">PID F/B Source</th> </tr> </thead> <tbody> <tr> <td data-bbox="351 469 400 496">0</td> <td data-bbox="400 469 490 496">Keypad</td> <td data-bbox="878 469 897 496">X</td> </tr> <tr> <td data-bbox="351 501 400 528">1</td> <td data-bbox="400 501 874 528">V1 Terminal input for -10~10 V input voltage</td> <td data-bbox="878 501 897 528">O</td> </tr> <tr> <td data-bbox="351 533 400 560">2</td> <td data-bbox="400 533 874 560">I1 Terminal input 0-20 mA input current</td> <td data-bbox="878 533 897 560">O</td> </tr> <tr> <td data-bbox="351 564 400 608">3</td> <td data-bbox="400 564 874 608">[W/ optional I/O expansion module] Terminal input for -10~10 V input voltage</td> <td data-bbox="878 564 897 608">O</td> </tr> <tr> <td data-bbox="351 612 400 655">4</td> <td data-bbox="400 612 874 655">[W/ optional I/O expansion module] Terminal input 0-20 mA input current</td> <td data-bbox="878 612 897 655">O</td> </tr> <tr> <td data-bbox="351 660 400 687">5</td> <td data-bbox="400 660 874 687">Int. 485 RS-485 input terminal</td> <td data-bbox="878 660 897 687">O</td> </tr> <tr> <td data-bbox="351 692 400 735">6</td> <td data-bbox="400 692 874 735">[W/ optional encoder module] Pulse input terminal</td> <td data-bbox="878 692 897 735">O</td> </tr> <tr> <td data-bbox="351 740 400 783">7</td> <td data-bbox="400 740 874 783">[W/ optional communication module] Fieldbus Communication input</td> <td data-bbox="878 740 897 783">O</td> </tr> <tr> <td data-bbox="351 788 400 815">8</td> <td data-bbox="400 788 874 815">[W/ optional PLC module] Input from a PLC</td> <td data-bbox="878 788 897 815">O</td> </tr> <tr> <td data-bbox="351 820 400 863">9</td> <td data-bbox="400 820 874 863">[W/ optional synchronization module] Command via synchronization operation</td> <td data-bbox="878 820 897 863">O</td> </tr> <tr> <td data-bbox="351 868 400 906">10</td> <td data-bbox="400 868 874 906">[W/ optional BCD module] Command via BCD option module</td> <td data-bbox="878 868 897 906">X</td> </tr> </tbody> </table>	Setting	Function	PID F/B Source	0	Keypad	X	1	V1 Terminal input for -10~10 V input voltage	O	2	I1 Terminal input 0-20 mA input current	O	3	[W/ optional I/O expansion module] Terminal input for -10~10 V input voltage	O	4	[W/ optional I/O expansion module] Terminal input 0-20 mA input current	O	5	Int. 485 RS-485 input terminal	O	6	[W/ optional encoder module] Pulse input terminal	O	7	[W/ optional communication module] Fieldbus Communication input	O	8	[W/ optional PLC module] Input from a PLC	O	9	[W/ optional synchronization module] Command via synchronization operation	O	10	[W/ optional BCD module] Command via BCD option module	X
	Setting	Function	PID F/B Source																																		
	0	Keypad	X																																		
	1	V1 Terminal input for -10~10 V input voltage	O																																		
	2	I1 Terminal input 0-20 mA input current	O																																		
	3	[W/ optional I/O expansion module] Terminal input for -10~10 V input voltage	O																																		
	4	[W/ optional I/O expansion module] Terminal input 0-20 mA input current	O																																		
	5	Int. 485 RS-485 input terminal	O																																		
	6	[W/ optional encoder module] Pulse input terminal	O																																		
	7	[W/ optional communication module] Fieldbus Communication input	O																																		
	8	[W/ optional PLC module] Input from a PLC	O																																		
9	[W/ optional synchronization module] Command via synchronization operation	O																																			
10	[W/ optional BCD module] Command via BCD option module	X																																			
The PID reference source setting can be monitored at APP-17 (PID Ref Value) according to the information types for monitoring set at CNF-06-08.																																					
APP-21 PID F/B Source	<p>Sets a feedback input source for the PID control. Keypad input (keypad-1, keypad-2) cannot be selected as the source of FB input. Also, the input type selected as the PID input source at APP-19 (PID Ref Set) cannot be set as the PID feedback input source.</p> <p>For example, if the V1 terminal is set as the PID reference source at APP-20, you must select input types other than the V1 terminal as the PID feedback source.</p> <p>You can set codes 06-08 in the CNF group to "18 (PID Fdb Value)" to monitor the feedback values.</p>																																				
APP-22 PID P-Gain, APP-26 P Gain Scale	<p>Sets the output ratio for differences (errors) between the reference and feedback. If the P-gain is set to 50%, then 50% of the difference (error) is output.</p> <p>The setting range of P-gain is 0.0-1000.0%. You can set APP-26 (P-Gain Scale) to adjust the input scale if a more accurate control is required.</p>																																				

Code	Description																															
APP-23 PID I-Time	Sets the time to output accumulated errors. When the error is 100%, the time taken for 100% output is set. When the integral time (PID I-Time) is set to 1 second, 100% output occurs after 1 second of the error and remains at 100%. Differences in a normal state can be reduced by PID I Time. When the multi-function terminal block is set to "21 (I-Term Clear)" and is turned on, all of the accumulated errors are deleted.																															
APP-24 PID D-Time	Sets the output volume for the rate of change in errors. If the differential time (PID D-Time) is set to 1 ms and the rate of change in errors per sec is 100%, output occurs at 1% per 10 ms.																															
APP-25 PID F-Gain	Sets the ratio that adds the target to the PID output. Adjusting this value leads to a faster response.																															
APP-27 PID Out LPF	Used when the PID controller output changes too quickly or the entire system is unstable, due to severe oscillation. In general, a lower value (default value is 0) is used to speed up response time, but in some cases a higher value increases stability. The higher the value, the more stable the PID controller output is, but the slower the response time.																															
APP-28 PID Mode	Set APP-28 to "0 (Process PID)" to add certain target values to the PID output to produce the final output. Set APP-28 to "1 (Normal PID)" to use the PID output without additional processing (modification).																															
APP-29 PID Limit Hi, APP-30 PID Limit Lo	Sets the values to limit the output of the PID controller.																															
APP-32 PID Out Scale	Sets APP-32 to adjust the scale of the controller output.																															
PID Rev Run En	Default is set to "No". When set to "No", the lower limit frequency limit is set to 0 Hz when the frequency is decreased via PID control, so that it does not reverse. If it is set to "Yes", when the frequency decreases by PID control, it falls below 0 Hz and operates in the reverse direction.																															
APP-42 PID Unit Sel	Set APP-42 to select the unit for the PID control.																															
	<table border="1"> <thead> <tr> <th>Setting</th> <th>Unit</th> <th>Application</th> <th>Description</th> </tr> </thead> <tbody> <tr> <td>0</td> <td>%</td> <td>-</td> <td>Displays certain values into as a percentage.</td> </tr> <tr> <td>1</td> <td>Bar</td> <td rowspan="4">Pressure</td> <td rowspan="4">Units for expressing different types of pressure.</td> </tr> <tr> <td>2</td> <td>mBar</td> </tr> <tr> <td>3</td> <td>Pa</td> </tr> <tr> <td>4</td> <td>kPa</td> </tr> <tr> <td>5</td> <td>Hz</td> <td rowspan="2">Speed</td> <td rowspan="2">Units for inverter output frequency or motor revolution.</td> </tr> <tr> <td>6</td> <td>rpm</td> </tr> <tr> <td>7</td> <td>V</td> <td>Voltage</td> <td rowspan="2">Units for electric voltage, current, electrical consumption, or</td> </tr> <tr> <td>8</td> <td>I</td> <td>Current</td> </tr> </tbody> </table>	Setting	Unit	Application	Description	0	%	-	Displays certain values into as a percentage.	1	Bar	Pressure	Units for expressing different types of pressure.	2	mBar	3	Pa	4	kPa	5	Hz	Speed	Units for inverter output frequency or motor revolution.	6	rpm	7	V	Voltage	Units for electric voltage, current, electrical consumption, or	8	I	Current
	Setting	Unit	Application	Description																												
	0	%	-	Displays certain values into as a percentage.																												
	1	Bar	Pressure	Units for expressing different types of pressure.																												
	2	mBar																														
	3	Pa																														
	4	kPa																														
	5	Hz	Speed	Units for inverter output frequency or motor revolution.																												
6	rpm																															
7	V	Voltage	Units for electric voltage, current, electrical consumption, or																													
8	I	Current																														

Learning Advanced Features

Code	Description			
	9	kW	Electric power	consumed power.
	10	HP	Horse power	
	11	°F	Temperature	Units for expressing temperature.
	12	°C		
APP-43 PID Unit Gain, APP-44 PID Unit Scale	Adjust the unit value and scale to fit the unit selected at APP-42 (PID Unit Sel).			
APP-45 PID P2-Gain	Set APP-45 (PID P2-Gain) for an alternative PID controller gain and use the alternative gain via a terminal input. Set IN-65–75 to “23 (P Gain2)”. When the selected terminal is on, the gain set at APP-45 is used instead of the gain set at APP-22 and APP-23.			

PID Control Block Diagram

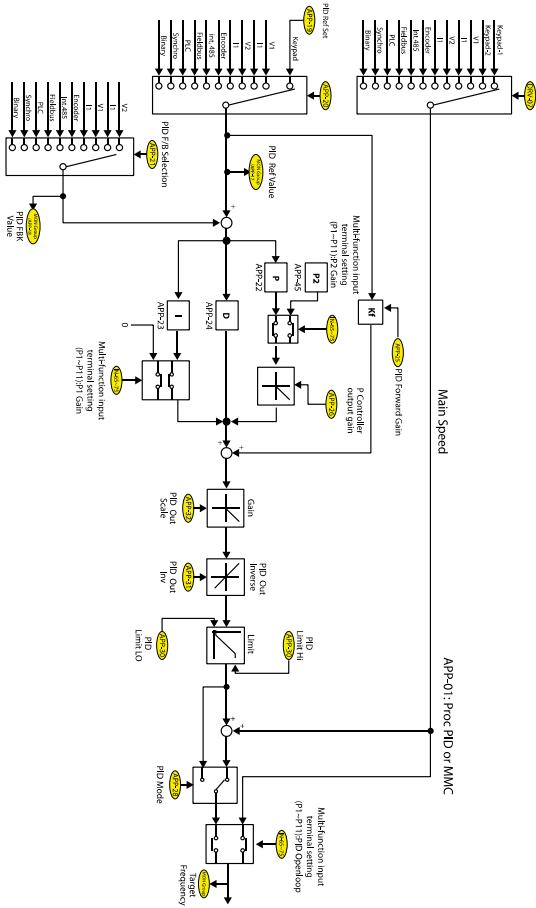

Note

- If the PID switching operation (switching from PID operation to normal operation) is performed at the multi-function inputs (P1-P11), % values are converted into Hz values.
- The polarity of the Normal PID output PID OUT is unipolar, and is limited by APP-29 (PID Limit Hi) and APP-30 (PID Limit Lo).
- 100% is based on the setting at DRV-20 (maxFreq).

8.8.2 Pre-PID Operation

Pre-PID operation refers to a section of a PID operation where the inverter runs without PID control. The inverter accelerates to a set frequency and runs without PID control, and then the PID control begins after the PID output exceeds the set value at APP-35 (Pre-PID Exit).

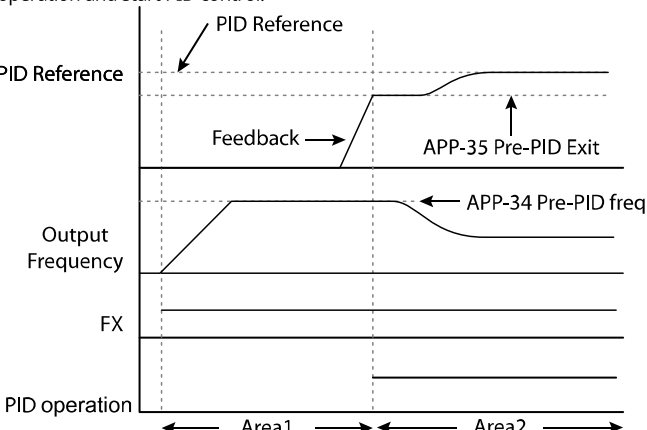
Code	Description
APP-34 Pre-PID Frq	Sets the target frequency to operate without PID control. The inverter continues running at the set frequency until the PID feedback exceeds the feedback value (%) set at APP-35.
APP-35 Pre-PID Exit	<p>Sets the feedback value of the PID control (PID reference) to stop pre-PID operation and start PID control.</p>  <p>The diagram illustrates the transition from pre-PID to PID control. It shows four main signals: PID Reference, Feedback, Output Frequency, and FX. The PID Reference signal starts at a low level and then steps up to a higher level. The Feedback signal starts at zero and rises to meet the PID Reference. The Output Frequency signal starts at a low level, ramps up to a constant level (labeled APP-34 Pre-PID freq), and then ramps down to a lower level. The FX signal is a constant high level. The PID operation signal is shown as a horizontal line at the bottom, with two regions labeled Area 1 and Area 2. Area 1 is the period before the feedback reaches the reference, and Area 2 is the period after the feedback reaches the reference.</p>
APP-36 Pre-PID Delay	Sets the time until a pre-PID fault trip occurs. If a feedback smaller than the PID reference set at APP-35 is maintained for the set time, a pre-PID fail trip occurs and inverter output is stopped.

8.8.3 PID Sleep Mode

If an operation continues at a frequency lower than the PID operation conditions at APP-38 (Sleep Freq) for a set duration at APP-37 (PID Sleep DT), the inverter enters PID sleep mode. In PID sleep mode, the inverter resumes PID operation when the PID Wakeup level conditions set at APP-39 (PID WakeUp Lev) are met.

Code	Description
APP-37 PID Sleep DT, APP-38 PID Sleep Freq	Sets the PID sleep frequency and delay time. The inverter stops operation and enters sleep mode if an operation is maintained at a frequency lower than the sleep frequency set at APP-38 for the time set at APP-37.
APP-39 PID WakeUp Lev, APP-40 PID WakeUp Mod	Sets the reference for PID wakeup at APP-39. If APP-40 is set to "0 (Below Level)", PID operation is resumed when the feedback volume is lower than the reference. If APP-40 is set to "0 (Below level)", PID operation will resume when the feedback volume is lower than the reference. If APP-40 is set to "1 (Above Level)", PID operation will resume when the feedback volume is higher than the reference. If APP-40 is set to "2 (Beyond level)", PID operation will resume when the difference between the speed reference and the feedback is larger than the wakeup reference set at APP-39.

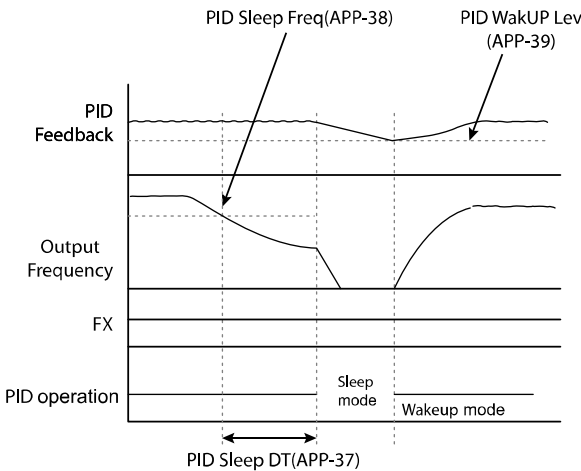

8.8.4 PID Switching (PID Openloop)

When one of the multi-function terminals (IN-65~75) is set to “22 (PID Openloop)” and is turned on, the PID operation stops and is switched to general operation. When the terminal turns off, the PID operation starts again.

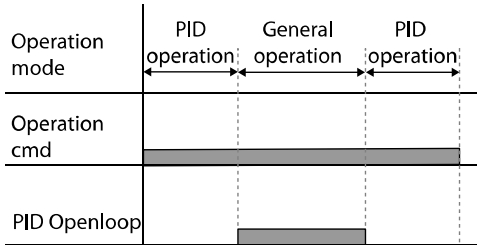

8.9 Auto Tuning

The motor parameters can be measured automatically and can be used for an auto torque boost or sensorless vector control.

Example - Auto Tuning Based on 0.75 kW, 220 V Motor

Group	Code	Name	LCD Display	Parameter Setting		Unit
DRV	14	Motor capacity	Motor Capacity	2	0.75 kW	kW
BAS	11	Motor pole number	Pole Number	4		-
	12	Rated slip speed	Rated Slip	40		Rpm
	13	Rated motor current	Rated Curr	3.6		A
	14	Motor no-load current	Noload curr	1.6		A
	15	Motor rated voltage	Rated Volt	220		V
	16	Motor efficiency	Efficiency	72		%
	20	Auto tuning	Auto Tuning	0	None	-
	21	Stator resistance	Rs	2.600		Ω
	22	Leakage inductance	Lsigma	17.94		mH
	23	Stator inductance	Ls	15.44		mH
APO	24	Rotor time constant	Tr	145		ms
	01	Encoder option mode	Enc Opt Mode	0	None	

Auto Tuning Default Parameter Setting

Motor Capacity (kW)	Rated Current (A)	No-load Current (A)	Rated Slip Frequency (Hz)	Stator Resistance (Ω)	Leakage Inductance (mH)	Stator Inductance [mH]	Rotator Time constant [ms]	
200 V	0.2	1.1	0.8	3.33	14.0	40.4	385	93
	0.4	2.4	1.4	3.33	6.70	26.9	206	116
	0.75	3.4	1.7	3.00	2.600	17.94	174.4	145
	1.5	6.4	2.6	2.67	1.170	9.29	115.8	162
	2.2	8.6	3.3	2.33	0.840	6.63	90.7	183
	3.7	13.8	5.0	2.33	0.500	4.48	59.7	211
	5.5	21.0	7.1	1.50	0.314	3.19	41.5	250
	7.5	28.2	9.3	1.33	0.169	2.844	31.86	271
	11	40.0	12.4	1.00	0.120	1.488	23.91	310
	15	53.6	15.5	1.00	0.084	1.118	19.07	350
	18.5	65.6	19.0	1.00	0.068	0.819	15.59	390
	22	76.8	21.5	1.00	0.056	0.948	13.79	435
	30	104.6	29.3	1.00	0.042	0.711	10.12	530
	37	128.6	34.7	1.00	0.033	0.568	8.54	600
	45	156.0	42.1	1.00	0.028	0.474	7.04	630
55	184.1	49.7	1.00	0.023	0.389	5.96	670	
75	244.5	61.1	1.00	0.016	0.284	4.85	800	
90	289.5	72.3	1.00	0.014	0.250	4.09	900	
400 V	0.2	0.7	0.5	3.33	28.00	121.2	1045	93
	0.4	1.4	0.8	3.33	14.0	80.8	610	116
	0.75	2.0	1.0	3.00	7.81	53.9	512	145
	1.5	3.7	1.5	2.67	3.52	27.9	346	162
	2.2	5.0	1.9	2.33	2.520	19.95	269.5	183
	3.7	8.0	2.9	2.33	1.500	13.45	177.8	211
	5.5	12.1	4.1	1.50	0.940	9.62	124.5	250
	7.5	16.3	5.4	1.33	0.520	8.53	95.2	271
	11	23.2	7.2	1.00	0.360	4.48	71.2	310
15	31.0	9.0	1.00	0.250	3.38	57	350	

Learning Advanced Features

Motor Capacity (kW)	Rated Current (A)	No-load Current (A)	Rated Slip Frequency (Hz)	Stator Resistance (Ω)	Leakage Inductance (mH)	Stator Inductance [mH]	Rotator Time constant [ms]
18.5	38.0	11.0	1.00	0.168	2.457	46.47	390
22	44.5	12.5	1.00	0.168	2.844	41.1	435
30	60.5	16.9	1.00	0.126	2.133	30.23	530
37	74.4	20.1	1.00	0.101	1.704	25.49	600
45	90.3	24.4	1.00	0.084	1.422	21.01	630
55	106.6	28.8	1.00	0.069	1.167	17.79	670
75	141.6	35.4	1.00	0.050	0.852	14.46	800
90	167.6	41.9	1.00	0.039	0.715	12.22	900
110	203.5	48.8	1.00	0.032	0.585	10.48	1000
132	242.3	58.1	1.00	0.027	0.488	8.8	1100
160	290.5	69.7	1.00	0.022	0.403	7.34	1200
185	335.0	77.0	1.00	0.021	0.380	6.64	1250
220	405	93.1	30	0.0163	0.293	5.467	1350
280	530.7	116.7	30	0.0128	0.23	4.386	1400
315	604	132.8	30	0.0114	0.204	3.854	1430
375	729.7	153.2	30	0.0096	0.171	3.342	1470

Auto Tuning Parameter Setting Details

Code	Description					
DRV-14 Motor Capacity	Set the motor capacity. The maximum motor capacity is limited by the inverter's capacity.					
BAS-20 Auto Tuning	Select an auto tuning type and run it. Select one of the options and then press the [PROG/ENT] key to run auto tuning.					
	<table border="1"> <thead> <tr> <th>Setting</th> <th>Function</th> </tr> </thead> <tbody> <tr> <td>0 None</td> <td>The auto tuning function is disabled. Also, if you select one of the auto tuning options and run it, the parameter value will revert back to 0 when auto tuning is complete.</td> </tr> <tr> <td>1 All</td> <td>Measures all motor parameters while the motor is rotating, including stator resistance (Rs), stator inductance (Lsigma), no-load current (Noload Curr), rotor time constant (Tr), etc. If an optional encoder module is installed, the inverter state is also measured (requires appropriate settings for encoder-related</td> </tr> </tbody> </table>	Setting	Function	0 None	The auto tuning function is disabled. Also, if you select one of the auto tuning options and run it, the parameter value will revert back to 0 when auto tuning is complete.	1 All
Setting	Function					
0 None	The auto tuning function is disabled. Also, if you select one of the auto tuning options and run it, the parameter value will revert back to 0 when auto tuning is complete.					
1 All	Measures all motor parameters while the motor is rotating, including stator resistance (Rs), stator inductance (Lsigma), no-load current (Noload Curr), rotor time constant (Tr), etc. If an optional encoder module is installed, the inverter state is also measured (requires appropriate settings for encoder-related					

Code	Description
	<p>functions). Use this setting when DRV-09 (Control mode) is set to "5 (Vector)". Since the motor is rotating while the parameters are being measured, if the load is connected to the motor spindle, the parameters may not be measured accurately. For accurate measurements, remove the load attached to the motor spindle. If DRV-09 (Control mode) is set to "4 (Sensorless-2)", the rotor time constant (Tr) must be measured in a stopped position.</p> <p>2 All (static type) Measures all parameters while the motor is in the stopped position, including stator resistance (Rs), stator inductance (Lsigma), no-load current (Noload Curr), rotor time constant (Tr), etc. Use this setting when DRV-09 (Control mode) is set to "4 (Sensorless-2)". Since the motor is not rotating while the parameters are measured, the measurements are not affected when the load is connected to the motor spindle.</p> <p>3 Rs+Lsigma Measures the stator resistance (Rs) and stator inductance (Lsigma) while the motor is not rotating. The measured values are used for auto torque boost and sensorless vector control. Since the motor is not rotating while the parameters are measured, the measurements are not affected when the load is connected to the motor spindle.</p> <p>4 Enc. Test Runs auto tuning after installing the optional encoder to the inverter and connecting the encoder cables to the motor. Auto tuning checks the cable connection. Ensure that the encoder related parameters are correctly set before auto tuning.</p> <p>5 Tr Uses this setting to measure the rotor time constant (Tr) when DRV-09 (Control mode) is set to "5 (Vector)". The motor rotates during auto tuning.</p> <p>6 Tr (Stdstl) Uses this setting to measure the rotor time constant (Tr) when DRV-09 (Control mode) is set to "4 (Sensorless-2)". The motor does not rotate during auto tuning.</p>
<p>BAS-14 Noload Curr, BAS-21 Rs-BAS-24 Tr</p>	<p>Displays motor parameters measured by auto tuning. For parameters that are not included in the auto tuning measurement list, the default setting will be displayed.</p>

⚠ Caution

- Perform auto tuning ONLY after the motor has completely stopped running.
- Before you run auto tuning, check the motor pole number, rated slip, rated current, rated voltage, and efficiency on the motor's rating plate and enter the data. The default parameter setting is used for values that are not entered.

Note

Before checking the encoder status using auto tuning, ensure that the following parameters are correctly set.

Group	Code	Name	LCD Display	Parameter Setting		Unit
BAS	20	Auto tuning	Auto Tuning	3	Enc Test	0-6
APO	01	Encoder option mode	Enc Opt Mode	1	Feedback	0-2
	04	Encoder type selection	Enc Type Sel	0	Line Driver	0-2
	05	Encoder pulse direction	Enc Pulse Sel	0	(A+B)	0-2
	06	Encoder pulse number	Enc Pulse Num	-	1024	10-5000
	08	Encoder feedback monitor	Enc Monitor	-	0	-

Encoder status checking details

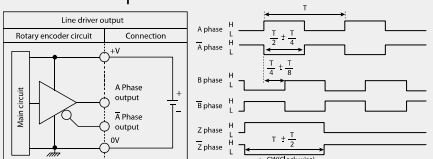
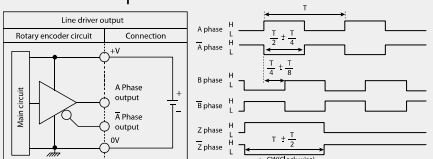
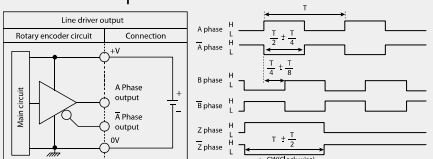
Code	Description				
BAS-20 Auto Tuning	<p>Sets the auto tuning type to “3 (Enc Test)” to check the encoder connection.</p> <p>The inverter operates in the Fx direction and accelerates to +20 Hz until it decelerates to 0 Hz and continues operating in the Rx direction, accelerating to -20 Hz.</p> <p>BAS-20 parameter value is automatically changed to “None” if a connection error is not detected.</p> <p>The “Enc reverse” message is displayed if the encoder connection is not correct. If this happens, you can change the APO-05 (ENC Pulse Sel) parameter setting to match the actual direction, or swap the two encoder cables that are connected to the motor.</p>				
APO-01 ENC Opt Mode	Sets the encoder option mode to “1 (Feed-back)”.				
APO-04 Enc Type Sel	<p>Select an encoder type.</p> <table border="1"> <thead> <tr> <th>Setting</th> <th>Output details</th> </tr> </thead> <tbody> <tr> <td>0 Line Driver</td> <td> <p>Line driver output</p>  </td> </tr> </tbody> </table>	Setting	Output details	0 Line Driver	<p>Line driver output</p> 
Setting	Output details				
0 Line Driver	<p>Line driver output</p> 				

	1	Totem or Com	<p>Totem pole output</p>
	2	Open Collector	<p>Open collector output</p>
APO-05 Enc Pulse Sel		Sets the direction of the encoder output pulse. 0: A+B (Fx, for frequency reference) / 1: -(A+B) (Rx)	
APO-06 Enc Pulse Num		Sets the number of output pulses per one motor revolution.	
APO-08 Enc Monitor		Converts the encoder output into motor speed (Hz or RPM) for monitoring.	

8.10 V/F Operation Using Speed Sensor

You can install an optional encoder module to the inverter to enhance the accuracy of V/F control. Before operating the inverter, check the encoder connection by running an auto tuning operation.

Group	Code	Name	LCD Display	Parameter Setting		Setting Range	Unit
DRV	09	Control mode	Control Mode	1	V/F PG	0-5	-
CON	45	PG operation proportional gain	PG P-Gain	-	3000	0-9999	-
	46	PG operation integral gain	PG I-Gain	-	50	0-9999	-
	47	PG operation maximum slip	PG Slip Max %	-	100	0-200	%
APO	01	Encoder option mode	Enc Opt Mode	1	Feed-back	0-2	-

V/F Operation Using Speed Sensor–Details

Code	Description
DRV-09 Control Mode	Sets the control mode to “1 (V/F PG)”. This mode adds a speed controller to a regular V/F mode. The command frequency becomes the speed reference of the speed controller, and the feedback is used as the encoder input.
CON-45 PG P-Gain, CON-46 PG I-Gain	Sets the proportional and integral gain (P-Gain/I-gain) of the speed controller. Higher P-gain results in a faster response. However, excessively high P-gain may lead to unstable operation. Lower I-gain results in a faster response. However, excessively low P-gain may lead to unstable operation.
CON-47 PG Slip Max %	Sets the maximum slip for the speed controller as a percentage (%) based on the rated slip set at BAS-12 (Rated Slip). For example, if CON-47 is set to 90% when the rated slip set at BAS-12 is 30 rpm, the maximum slip for the speed controller becomes 27 rpm, (90% of 30 rpm,).

8.11 Sensorless-1 Vector Control

Sensorless-1 vector control mode provides high performance operation without requiring a speed sensor. Motor parameter information is required for sensorless-1 vector control mode. Before operating the inverter in sensorless-1 mode, run auto tuning first.

Group	Code	Name	LCD Display	Parameter Setting		Unit
DRV	09	Control mode	Control Mode	3	Sensorless-1	-
	10	Torque control option	Torque Control	0	No	-
	14	Motor-rated capacity	Motor Capacity	x	x.xx	kW
BAS	11	Motor pole number	Pole Number	-	4	-
	12	Motor-rated slip	Rated Slip	-	2.00	Hz
	13	Motor-rated current	Rated Curr	-	3.6	A
	14	Motor No-load current	Noload curr	-	0.7	A
	15	Motor-rated voltage	Rated Volt	-	220	V
	16	Motor efficiency	Efficiency	-	83	%

Group	Code	Name	LCD Display	Parameter Setting		Unit
	20	Auto tuning options	Auto Tuning	2	Rs+Lsigma	-
CON	21	Sensorless speed controller proportional gain 1	ASR-SL P Gain1	-	100.0	%
	22	Sensorless speed controller integral gain 1	ASR-SL I Gain1	-	150	ms

⚠ Caution

- For sensorless-1 mode operation, the motor’s rated capacity must match the inverter’s rated capacity. If the inverter capacity is too large for the installed motor, run the motor in V/F mode.
- Sensorless-1 mode operation does not support multiple motor control (MMC) features. Do not connect multiple motors to one inverter that is operating in sensorless-1 mode.

Sensorless-1 Vector Control–Details

Code	Description
DRV-14 Motor Capacity, BAS-11 Pole Number, BAS-12 Rated Slip, BAS-13 Rated Curr, BAS-15 Rated Volt, BAS-16 Efficiency	Motor parameter information is required for sensorless-1 vector control mode. Check the motor’s rating plate for the motor capacity and other performance-related information, set the relevant parameters, and then run auto tuning at BAS-20.
BAS-20 Auto Tuning	After setting all the parameter values (DRV-14 Motor Capacity, BAS-11 Pole Number, BAS-12 Rated Slip, BAS-13 Rated Curr, BAS-15 Rated Volt, and BAS-16 Efficiency), perform auto tuning. To perform astatic auto tuning when the motor does not rotate, set BAS-20 to 2 (Rs+Lsigma). The default motor no-load current is used, and the motor stator resistance (Rs) and leakage inductance (Lsigma) values are saved at BAS-21 and BAS-22. To perform rotating auto tuning , separate the load from the motor axis, if possible, and set BAS-20 to “1 (ALL)”. The motor no-load current, motor stator resistance (Rs), and motor leakage inductance (Lsigma) values are saved at BAS-14, BAS-21, and BAS-22 respectively.
CON-21 ASR-SL P Gain1, CON-22 ASR-SL I Gain1	Set the speed controller proportionately and integral gains for sensorless-1 vector control according to the default motor parameters and acc/dec time.

Code	Description
	<p>ⓘ Caution</p> <p>Appropriate controller gain values must be set based on the load characteristics. Motor overheating or an unstable system may result if the gain values are not properly set.</p>
DRV-10 Torque Control	<p>Selects the speed control and torque control modes. If you set DRV-10 (Torque control) to "1 (Yes)", the operation switches into torque control mode. Refer to 8.14 Torque Control on page 242 for details.</p> <p>ⓘ Caution</p> <ul style="list-style-type: none"> • Torque control is not available during low-speed regeneration and low-speed operation under a light load. Select vector control mode instead. • When the inverter is operated in torque control mode, do not switch between forward and reverse rotations. Overcurrent or Rx deceleration fault trips may result. • When the inverter is operated in sensorless vector control mode, enable accelerating speed search by setting the CON-71 (Speed search) bits to "0001" if the inverter is expected to start or restart while the motor is free-running.

8.12 Sensorless-2 Vector Control

Similar to sensorless-1 vector control mode, sensorless-2 vector control mode provides high-performance inverter operation without requiring a speed sensor. It utilizes various gain values for more precise vector control.

Motor parameter information is required for sensorless-2 vector control mode. Before operating the inverter in sensorless-2 mode, run auto tuning first.

Group	Code	Name	LCD Display	Parameter Setting	Unit
DRV	09	Control mode	Control Mode	4 Sensorless-2	-
	10	Torque control option	Torque Control	0 No	-
	14	Motor-rated capacity	Motor Capacity	x Varies depending on motor capacity.	kW
BAS	11	Motor pole number	Pole Number	- 4	-

Group	Code	Name	LCD Display	Parameter Setting	Unit
CON	12	Motor-rated slip	Rated Slip	- Varies depending on motor capacity.	Hz
	13	Motor-rated current	Rated Curr	- Varies depending on motor capacity.	A
	14	Motor No-load current	Noload curr	- Varies depending on motor capacity.	A
	15	Motor-rated voltage	Rated Volt	- 220/380/440/480	V
	16	Motor efficiency	Efficiency	- Varies depending on motor capacity.	%
	20	Auto tuning options	Auto Tuning	1 All	-
	20	Sensorless 2nd gain display setting	SL2 G View Sel	1 Yes	-
	21	Sensorless speed controller proportional gain1	ASR-SL P Gain1	- Varies depending on motor capacity.	%
	22	Sensorless speed controller integral gain 1	ASR-SL I Gain1	- Varies depending on motor capacity.	ms
	23	Senseless speed controller proportional gain 2	ASR-SL P Gain2	- Varies depending on motor capacity.	%
	24	Sensorless2 speed controller integral gain 2	ASR-SL I Gain2	- Varies depending on motor capacity.	%
	26	Sensorless2 measurer gain 1	Observer Gain1	- 10500	-
	27	Sensorless2 measurer gain 2	Observer Gain2	- 100.0	%
	28	Sensorless2 measurer gain 3	Observer Gain3	- 13000	-
	29	Sensorless2 speed estimator proportional gain 1	S-Est P Gain 1	- Varies depending on motor capacity.	-
	30	Sensorless2 speed estimator integral gain 1	S-Est I Gain 1	- Varies depending on motor capacity.	-
	31	Sensorless2 speed estimator proportional gain 2	S-Est P Gain 2	- Varies depending on motor capacity.	%
	32	Sensorless2 speed estimator integral gain 2	S-Est I Gain 2	- Varies depending on motor capacity.	%
	48	Current controller P gain	ACR P-Gain	- 1200	-
	49	Current controller I gain	ACR I-Gain	- 120	-

ⓘ Caution

- For sensorless-2 mode operation, the motor-rated capacity must match the inverter's rated capacity. If the inverter capacity is too large for the installed motor, run the motor in V/F mode.
- Sensorless-2 mode does not support multiple motor control (MMC) features. Do not connect multiple motors to one inverter that is operating in sensorless-1 mode.

Sensorless-2 Vector Control–Details

Code	Description
DRV-14 Motor Capacity, BAS-11 Pole Number, BAS-12 Rated Slip, BAS-13 Rated Curr, BAS-15 Rated Volt, BAS-16 Efficiency	Motor parameter information is required for sensorless-2 vector control mode. Check the motor's rating plate for the motor capacity and other performance related information, set the relevant parameters, and then run auto tuning at BAS-20.
BAS-20 Auto Tuning	After setting all the parameter values (DRV-14 Motor Capacity, BAS-11 Pole Number, BAS-12 Rated Slip, BAS-13 Rated Curr, BAS-15 Rated Volt, and BAS-16 Efficiency), perform a rotating auto tuning. To perform rotating auto tuning , separate the load from the motor axis, and set BAS-20 to "1 (ALL)". The motor stator resistance (Rs), leakage inductance (Lsigma), stator inductance (Ls), no-load current (Noload Curr), and rotor time constant (Tr) are saved in BAS-21, BAS-22, BAS-23, BAS-14, and BAS-24, respectively.
CON-20 SL2 G View Sel	Set CON-20 to "1 (Yes)" to view various medium speed* gains (CON-23 ASR-SL P Gain2, CON-24 ASR-SL I Gain2, CON-27 Observer Gain2, CON-28 Observer Gain3, CON-31 S-Est P Gain2, and CON-32 S-Est I Gain2) for user configuration. These parameters are not visible if CON-20 is set to "0 (No)". *Medium speed: A speed range that is approximately 50% of the base frequency.
CON-21 ASR-SL P Gain1, CON-22 ASR-SL I Gain1	Sets the speed controller proportionately and integral gain values for sensorless-2 vector control. The P-gain is proportionate to speed deviation. Increasing the P-gain increases torque output and immediately eliminates speed deviation. The I-gain is an integral gain which represents the time (ms) until the torque output is made under a steady speed deviation. Decreasing the I-gain can eliminate the speed deviation faster. After setting the speed controller gain values, observe the changes and fine-tune the values to improve the speed control waveforms. Note that vibration may result if the set P-gain value is too large or the set I-gain value is too small. If oscillation is observed in the waveform, first increase the I-gain, and then increase the P-gain to find the optimal

Code	Description
<p>CON-23 ASR-SL P Gain2, CON-24 ASR-SL I Gain2</p>	<p>values.</p> <p>These codes are visible only when CON-20 is set to "1 (yes)". Set the speed controller proportionately and integral gain values for sensorless-2 vector control for operation speeds greater than 50% of the base frequency.</p> <p>CON-23 (ASR-SL P Gain2) and CON-24 (ASR-SL I Gain2) are set as percentage values (%) based on the proportionately set speed controller and integral gain1 values set at CON-21 (ASR-SL P Gain1) and CON-22 (ASR-SL I Gain1).</p> <p>Therefore, P-gain2 and I-gain2 values of less than 100% result in decreased responsiveness when the inverter is operating above medium speed.* For example, if both P-gain1 and P-gain2 are set to 50%, the actual P-gain2 value is 25% of the reference. Likewise, if I-gain1 is set to 100 ms and I-gain2 is set to 50%, the resulting I-gain 2 value becomes 200 ms. By default, the speed controller gain values are set according to the motor parameters and acceleration and deceleration times.</p> <p>*Medium speed: A speed range that is approximately 50% of the base frequency.</p>
<p>CON-26 Observer Gain1, CON-27 Observer Gain2, CON-28 Observer Gain3</p> <p>CON-29 S-Est P Gain1, CON-30 S-Est I Gain1</p>	<p>These codes are visible only when CON-20 is set to "1 (yes)". The observer gain values may be adjusted by system engineers only. Sensorless-2 vector control mode requires the observers to estimate the motor's stator current and rotor magnetic flux.</p> <p>While observer gain1 (CON-26) is applied when the inverter operates at low to medium speeds, observer gain2 (CON-27) is applied when the inverter operates at medium to high speeds. Observer gain3 (CON-28) is applied in torque control mode.</p> <p>Sets the speed estimator gain values for sensorless-2 vector control mode. Increase or decrease the speed estimator P-gain or I-gain by small increments if the displayed speed does not match the speed reference.</p> <p>You can also adjust the speed estimator gain values if the motor vibrates severely, or a high current ripple occurs at power on. Decrease the speed estimator P-gain or I-gain gradually to reduce the vibration or current ripple.</p> <p>By default, the speed estimator gains are set according to the default motor parameters and acceleration and deceleration times.</p>
<p>CON-31 S-Est P Gain2, CON-32 S-Est I Gain2</p>	<p>These codes are visible only when CON-20 is set to "1 (yes)".</p> <p>You can set the speed estimator gains to a frequency higher than the medium speed* in sensorless-2 vector control mode.</p> <p>CON-31 and CON-32 are set as percentage values of low-speed gain values set at CON-29 and CON-30. For example, if CON-29 S-Est P-Gain1</p>

Code	Description
	<p>is 300 and CON-31 S-Est P-Gain2 is 40.0%, the speed estimator P-gain at higher than the actual medium speed is 120.</p> <p>By default, the speed estimator gains are set according to the default motor parameters and acceleration and deceleration times.</p> <p>*Medium speed: A speed range that is approximately 50% of the base frequency.</p>
CON-34 SL2 OVM Perc	<p>When the output voltage/input voltage ratio is below 100% (when the output voltage is not over modulated), the output voltage bears linear characteristics to the input voltage. In sensorless-2 control mode, you can set CON-34 (SL2 OVM Perc) to define a voltage range to be limited in the over modulated zone. By default, CON-34 (SL2 OVM Perc) is set as 120%. However, for a high-impact load where the load often exceeds the torque limit, such as a press load, you can increase the limit value to avoid frequent over current fault trips.</p> <p>Also, in areas where the power supply is unstable, the input voltage tends to be lower than the rated input voltage, which results in more frequent overcurrent (OC1) fault trips with aforementioned high-impact load applications. If this is the case, you can set CON-34 (SL2 OVM Perc) as 140–150% to avoid frequent fault trips.</p>
CON-48 ACR P-Gain, CON-49 ACR I Gain	<p>Sets the current PI controller P-gain and I-gain values.</p>
DRV-10 Torque Control	<p>Selects the speed control and torque control modes. If you set DRV-10 (Torque control) to "1 (Yes)", the operation switches to torque control mode.</p> <p>Refer to 8.14 Torque Control on page 242 for details.</p> <p>⚠ Caution</p> <ul style="list-style-type: none"> • Torque control is not available during low-speed regeneration and low-speed operation under a light load. Select vector control mode instead. • When the inverter is operated in torque control mode, do not switch between forward and reverse rotations. Overcurrent or Rx deceleration fault trips may occur. • When the inverter is operated in sensorless vector control mode, enable accelerating speed search by setting the CON-71 (Speed search) bits to "0001," if the inverter is expected to start or restart while the motor is free-running.

⚠ Caution

In sensorless-2 control mode, the motor may overheat or the system may become unstable if the gain values are not properly set.

Note

Sensorless-2 vector control mode is greatly affected by the motor and load characteristics. Therefore, it is sometimes necessary to adjust the controller gain values.

When a sensorless-2 vector control is operated in speed mode [DRV-10 (torque control) is set to "0 (No)". If the operation is unstable at extremely low speeds (below 2–3 Hz), or if the speed bounces during startup, increase the CON-22 (ASR-SL I Gain1) value to 200% of the default value. With a regenerative load, motor torque ripples may occur frequently. In this case, decrease the CON-21 (ASR-SL P Gain1) value to 50% of the default value. If this does not solve the problem, increase the CON-21 (ASR-SL P Gain1) value back to the default, and decrease the CON-30 (S-Est I Gain1) value to 50% of the default value.

8.13 Vector Control Mode Operation

With an optional encoder module installed to the inverter, vector control mode provides highly precise operation abilities.

Similar to sensorless-1 and sensorless-2 vector control modes, vector control mode requires motor parameter values for operation. Before operating the inverter in sensorless-2 mode, run auto tuning first.

Group	Code	Name	LCD Display	Parameter Setting		Unit
DRV	09	Control mode	Control Mode	5	Vector	-
	21	Speed unit selection	Hz / rpm Sel	1	Rpm Display	-
BAS	20	Auto tuning	Auto Tuning	1	All	-
CON	09	Initial excitation time	PreExTime	-	1.0	sec
	10	Initial excitation power supply	Flux Force	-	100.0	%
	11	Continued operation duration	Hold Time	-	1.0	sec
	12	Speed controller proportional gain 1	ASR P Gain 1	-	50.0	%
	13	Speed controller integral gain 1	ASR I Gain 1	-	300	ms
	15	Speed controller proportional gain 2	ASR P Gain 2	-	50.0	%
	16	Speed controller integral gain 2	ASR I Gain 2	-	300	ms
	18	Gain exchange frequency	Gain Sw Freq	-	0.00	Hz
	19	Gain exchange time	Gain Sw Delay	-	0.10	sec

Learning Advanced Features

Group	Code	Name	LCD Display	Parameter Setting		Unit
	51	Speed controller reference filter	ASR Ref LPF	-	0	ms
	52	Torque controller output filter	Torque Out LPF	-	0	ms
	53	Torque limit setting options	Torque Lmt Src	0	Keypad-1	-
	54	Forward offsetting torque limit	FWD +Trq Lmt	-	180	%
	55	Forward regenerative torque limit	FWD -Trq Lmt	-	180	%
	56	Reverse offsetting torque limit	REV +Trq Lmt	-	180	%
	57	Reverse regenerative torque limit	REV -Trq Lmt	-	180	%
	58	Torque bias setting options	Trq Bias Src	0	Keypad-1	-
	59	Torque bias	Torque Bias	-	0.0	%
	60	Torque bias compensation	Trq BiasFF	-	0.0	%
IN	65-75	PX terminal function setting	Px Define	36	Asr Gain 2	-
	65-75	PX terminal function setting	Px Define	37	ASR P/PI	-

⚠ Caution

- For vector control mode operation, the motor-rated capacity must match the inverter's rated capacity. If the inverter capacity is too large for the installed motor, run the motor in V/F mode.
- Vector control mode does not support multiple motor control (MMC) features. Do not connect multiple motors to one inverter that is operating in vector control mode.

Vector Control Mode-Details

Code	Description
DRV-14 Motor Capacity, BAS-11 Pole Number, BAS-12 Rated Slip, BAS-13 Rated Curr,	Motor parameter information is required for vector control mode operation. Check the motor's rating plate for the motor capacity and other performance-related information, set the relevant parameters, and

Code	Description								
BAS-15 Rated Volt, BAS-16 Efficiency	then run auto tuning at BAS-20.								
APO-01 Enc Opt Mode	Sets the encoder option mode to "1 (feedback)".								
APO-04 Enc Type Sel	Sets the encoder's signal delivery options. Refer to the instruction manual supplied with the encoder and select one of the following options: 0: Line Driver / 1: Totem or Com / 2: Open Collect								
APO-05 Enc Pulse Sel	Sets the encoder output pulse options. <table border="1"> <thead> <tr> <th>Setting</th> <th>Description</th> </tr> </thead> <tbody> <tr> <td>0 (A+B)</td> <td>Fx operation</td> </tr> <tr> <td>1 (A+B)</td> <td>Rx operation</td> </tr> <tr> <td>2 A</td> <td>Frequency reference</td> </tr> </tbody> </table>	Setting	Description	0 (A+B)	Fx operation	1 (A+B)	Rx operation	2 A	Frequency reference
Setting	Description								
0 (A+B)	Fx operation								
1 (A+B)	Rx operation								
2 A	Frequency reference								
APO-06 Enc Pulse Num	Sets the number of pulses per rotation.								
APO-08 Enc Monitor	Converts the encoder output into motor rotation and displays in Hz or rpm units.								
BAS-20 Auto Tuning	<p>To test the encoder: Sets the auto tuning type to "3 (Enc Test)" to check the encoder connection. The inverter operates in the Fx direction and accelerates to 20 Hz until it decelerates to 0 Hz and continues operating in the Rx direction, accelerating to 20 Hz. The BAS-20 parameter value is automatically changed to "None" if a connection error is not detected. The "Enc reverse" message is displayed if the encoder connection is not correct. If this happens, you can change the APO-05 (ENC Pulse Sel) parameter setting to match the actual direction, or swap the two encoder cables that are connected to the motor.</p> <p>To perform rotating auto tuning, separate the load from the motor axis, and set BAS-20 to "1 (ALL)". The motor stator resistance (Rs), leakage inductance (Lsigma), stator inductance (Ls), no-load current (Noload Curr) and rotor time constant (Tr) are saved in BAS-21, BAS-22, BAS-23, BAS-14, and BAS-24 respectively.</p>								
CON-09 PreExTime	Sets the initial excitation time. Operation begins after the motor is excited to the rated speed.								
CON-10 Flux Force	Flux force may be used to reduce the initial excitation time. The motor flux increases based on a time constant. To reduce the time to reach the rated flux, you can supply a flux larger than the rating at first, and								

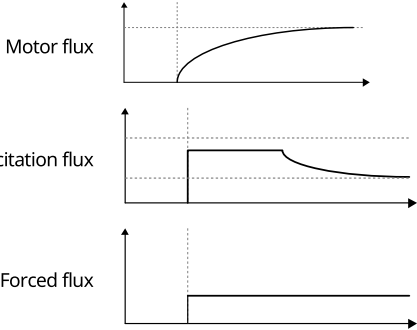
Code	Description									
	<p>then reduce the amount of flux when the motor is excited close to the rated flux.</p> 									
CON-12 ASR P Gain1, CON-13 ASR I Gain1	<p>Sets the speed controller proportional and integral gain values. Increasing the P-gain increases responsiveness and torque output, while decreasing the I-gain increases responsiveness. However, note that excessively high P-gain or low I-gain settings may result in motor speed oscillation.</p>									
CON-15 ASR P Gain2, CON-16 ASR I Gain2	<p>These codes are used to configure the gains that are applied based on the load characteristics and motor speed. The switching of gain values is performed based on the switching frequency set at CON-18 and the switching time set at CON-19.</p>									
CON-51 ASR Ref LPF	<p>Sets the filter time constant that is used in vector speed mode for the speed controller.</p>									
CON-52 Torque Out LPF	<p>Sets the filter time constant that can be used in vector speed or vector torque mode. In vector speed mode, it is applied to the speed controller. In vector torque mode, it is applied to the torque reference.</p>									
CON-48 ACR P-Gain, CON-49 ACR I Gain	<p>Sets the P- and I-gain values for the current PI controller. These gains are used in sensorless speed/torque modes and vector speed/torque modes.</p>									
IN-65–75 Px Define	<p>Sets the multi-function terminals to control the gains and controllers.</p>									
	<table border="1"> <thead> <tr> <th data-bbox="376 1257 426 1278">Setting</th> <th data-bbox="426 1257 546 1278"></th> <th data-bbox="546 1257 966 1278">Description</th> </tr> </thead> <tbody> <tr> <td data-bbox="376 1278 426 1331">36</td> <td data-bbox="426 1278 546 1331">ASR Gain2</td> <td data-bbox="546 1278 966 1331">When the terminal is on, gain switching takes place after the time set at CON-19 has passed.</td> </tr> <tr> <td data-bbox="376 1331 426 1380">37</td> <td data-bbox="426 1331 546 1380">ASR P/PI</td> <td data-bbox="546 1331 966 1380">When the terminal is on, the integral controller stops operating.</td> </tr> </tbody> </table>	Setting		Description	36	ASR Gain2	When the terminal is on, gain switching takes place after the time set at CON-19 has passed.	37	ASR P/PI	When the terminal is on, the integral controller stops operating.
	Setting		Description							
36	ASR Gain2	When the terminal is on, gain switching takes place after the time set at CON-19 has passed.								
37	ASR P/PI	When the terminal is on, the integral controller stops operating.								

Code	Description												
CON-53 Torque Lmt Src	Sets the input source for the torque limit function. The torque limit function is used to limit the output to adjust the torque reference.												
	<table border="1"> <thead> <tr> <th>Setting</th> <th>Description</th> </tr> </thead> <tbody> <tr> <td>0</td> <td>Keypad-1</td> </tr> <tr> <td>1</td> <td>Keypad-2</td> </tr> <tr> <td>2</td> <td>V1</td> </tr> <tr> <td>3</td> <td>I1</td> </tr> <tr> <td>6</td> <td>Int 485</td> </tr> </tbody> </table>	Setting	Description	0	Keypad-1	1	Keypad-2	2	V1	3	I1	6	Int 485
	Setting	Description											
	0	Keypad-1											
	1	Keypad-2											
2	V1												
3	I1												
6	Int 485												
	Sets the torque limit using the keypad (up to 200% of the motor rated torque).												
	Sets the torque limit using the analog terminals.												
	Sets the torque limit using the built-in 485 communication device.												
IN-02 Torque at 100%	<p>Sets the torque limit values for the analog input. If CON-53 is set to "2 (V1)" and IN-02 is set to "200%", the torque limit becomes 200% when 10 V input is supplied to V1.* (*Applies only if all V1 function parameters use default setting values.) When any device other than the keypad is selected as the torque limit input source, set CNF-21–23 to "21 (Torque Limit)".</p>												
CON-54 FWD +Trq Lmt CON-55 FWD –Trq Lmt CON-56 REV +Trq Lmt CON-57 REV –Trq Lmt	Sets the direction of the torque limit when CON-53 is set to "0 (Keypad-1)" or "1 (Keypad-2)". The torque limit can be set up to 200% of the motor rated torque.												
	<table border="1"> <thead> <tr> <th>Setting</th> <th>Description</th> </tr> </thead> <tbody> <tr> <td>FWD +Trq Lmt</td> <td>Sets the torque limit for FX motoring operation.</td> </tr> <tr> <td>FWD –Trq Lmt</td> <td>Sets the torque limit for FX regenerating operation.</td> </tr> <tr> <td>REV +Trq Lmt</td> <td>Sets the torque limit for RX motoring operation.</td> </tr> <tr> <td>REV –Trq Lmt</td> <td>Sets the torque limit for RX regenerating operation.</td> </tr> </tbody> </table>	Setting	Description	FWD +Trq Lmt	Sets the torque limit for FX motoring operation.	FWD –Trq Lmt	Sets the torque limit for FX regenerating operation.	REV +Trq Lmt	Sets the torque limit for RX motoring operation.	REV –Trq Lmt	Sets the torque limit for RX regenerating operation.		
	Setting	Description											
	FWD +Trq Lmt	Sets the torque limit for FX motoring operation.											
	FWD –Trq Lmt	Sets the torque limit for FX regenerating operation.											
REV +Trq Lmt	Sets the torque limit for RX motoring operation.												
REV –Trq Lmt	Sets the torque limit for RX regenerating operation.												
CON-58 Trq Bias Src	Selects the input source for the offset setting to be added to the torque reference.												
	<table border="1"> <thead> <tr> <th>Setting</th> <th>Description</th> </tr> </thead> <tbody> <tr> <td>0</td> <td>Keypad-1</td> </tr> <tr> <td>1</td> <td>Keypad-2</td> </tr> <tr> <td>2</td> <td>V1</td> </tr> <tr> <td>3</td> <td>I1</td> </tr> </tbody> </table>	Setting	Description	0	Keypad-1	1	Keypad-2	2	V1	3	I1		
	Setting	Description											
	0	Keypad-1											
1	Keypad-2												
2	V1												
3	I1												
	Sets the torque bias using the keypad (-120% – +120%, set at CON-59).												
	Sets the torque bias using the analog terminals. (-120% – +120%, set at CON-59). The setting can be viewed in monitor mode. Set CFG-06–08 to "21 (Torque bias)".												
CON-59 Torque Bias	Sets the torque bias value between -120%– +120%.												
IN-65–75 Px Define	Sets one of the multi-function terminals to "48 (Trq Bias)". Torque bias input via the keypad or analog input is applied only when this multi-function terminal is on.												
CON-60 Trq BiasFF	Sets the compensation volume to add to the bias to make up for the loss caused by motor rotation. Negative (-) values diminish the torque bias.												

Code	Description
CON-11 Hold Time	<p>When a run command stops, the inverter holds the zero speed output for the set time before the motor decelerates to a complete stop.</p>

8.14 Torque Control

You can use torque control to operate the inverter to produce a certain amount of torque as indicated by the torque reference. In torque control mode, the motor speed is decided by the amount of load because a motor can run at a constant speed when the output torque and torque load are equal. The motor speed increases when the output torque becomes greater than the torque load. You can set a speed limit to maintain the motor speed within a certain range. Note that torque control is not available during the speed control operations.

Group	Code	Name	LCD Display	Parameter Setting		Unit
DRV	02	Torque command	Cmd Torque	-	0.0	%
	08	Torque reference source	Trq Ref Src	0	Keypad-1	-
	09	Control mode	Control Mode	5	Vector	-
	10	Torque control	Torque Control	1	Yes	-
BAS	20	Auto tuning	Auto Tuning	1	Yes	-
CON	35	SL2 L-ExcitLmt	SL2 L-ExcitLmt	-	10	%
	62	Speed limit setting options	Speed Lmt Src	0	Keypad-1	-
	63	Forward speed limit	FWD Speed Lmt	-	60.00	Hz
	64	Reverse speed limit	REV Speed Lmt	-	60.00	Hz
	65	Speed limit operation gain	Speed Lmt Gain	-	500	%
IN	65-75	PX terminal function setting	Px Define	35	Speed/Torque	-
OUT	31-33	Multi-function relay, Multi-function output 1	Relay x or Q1	27	Torque Dect	-
	59	Detected torque amount	TD Level	-	100	%
	60	Detected torque width	TD Band	-	5.0	%

Note

- Basic parameters for inverter operation must be correctly set before you can operate the inverter in torque control mode.
- Torque control is not available during low speed regeneration and light load operation. Operate the inverter in vector control mode instead.
- Do not switch between Fx and Rx operations while the inverter is operating in torque control mode. An overcurrent or reverse deceleration fault trip may occur as a result.

Torque Control-Details

Code	Description		
DRV-08 Trq Ref Src	Select the input source for the torque reference.		
	Setting	Description	
	0	Keypad-1	Sets the torque reference using the keypad (up to 180% of rated motor torque, set at CON-02).
	1	Keypad-2	
	2	V1	Sets the torque reference using the analog terminals. The torque reference changes based on the set value at IN-02 (Torque at 100%). For example, if IN-02 is set to 200%, the torque reference becomes 200% when 20 mA current is supplied. The setting can be viewed in monitor mode. Set CFG-06-08 to "19 (Torque Ref)".
3	I1		
6	Int485	Sets the torque reference using the built-in RS485 communication device.	
CON-02 CMD Torque	Sets the torque reference for keypad input.		
IN-02 Torque at 100%	Sets the torque reference for analog terminal input.		
CON-35 SL2 L-ExcitLmt	This is the ratio to improve the operating characteristics in the low torque/low speed range by lowering the magnetic flux current. However, if the value is set too low, stable sensorless control may not be possible.		
CON-62 Speed Lmt Src	Select the input source for the speed limit.		
	Setting	Description	
	0	Keypad-1	Sets the speed limit using the keypad (CON-63 FWD Speed Lmt / CON-64 REV Speed Lmt).
	1	Keypad-2	
	2	V1	Set the torque reference using the analog terminals, in the same manner as setting a frequency reference.
3	I1		
6	Int485	The setting can be viewed in monitor mode. Set CNF-21-23 to "23 (Speed Limit)".	

Code	Description
CON-65 Speed Lmt Gain	Set the torque reference decrement rate between 100%–5000% for when the speed limit is exceeded.
IN-65–75 Px Define	Sets one of the multi-function inputs to “35 (Speed/Torque)”. Switching between torque control mode and speed (vector) control mode takes place when the terminal is on.

8.15 Droop Control

Droop control is used to balance the load when operating multiple motors for a single load, or to prevent speed controller saturation in vector control mode.

Group	Code	Name	LCD Display	Parameter Setting		Unit
CON	66	Droop operation amount	Droop Perc	-	0.0	%
	67	Droop start torque	Droop St Torque	-	100.0	%

Droop Control–Details

Code	Description
CON-66 Droop Perc	Sets the percentage rate for the droop operation based on the rated torque.
CON-67 Droop start torque	Sets the torque to start droop operation. Based on the set value, the motor speed can be calculated as follows: $\text{Droop speed} = \text{Maximum frequency} \times \text{Droop Perc} \times \frac{\text{Torque reference} - \text{Droop St Torque}}{100\% \text{ torque} - \text{Droop St Torque}}$

8.16 Speed / Torque Control Switching

Set one of the multi-function terminals to switch between speed and torque control modes. This function is only available in vector control mode.

Group	Code	Name	LCD Display	Parameter Setting		Unit
CON	68	Torque mode–speed mode switching	SPD/TRQAcc T	-	20.0	sec

Group	Code	Name	LCD Display	Parameter Setting		Unit
		acceleration time				
	69	Torque mode-speed mode switching deceleration time	SPD/TRQDec T	-	30.0	sec
IN	65-75	Px terminal setting option	Px Define	35	Speed/Torque	-
DRV	09	Control mode	Control Mode	5	Vector	-
	10	Torque control	Torque Control	0	No	-
1				Yes	-	

Set a multi-function input Px to “35 (Speed/Torque)”.

If the terminal is on during a vector torque operation, where DRV-09 (Control Mode) is set to “5 (Vector)” and DRV-10 (Torque Control) is set to “1 (Yes)”, the operation switches from torque to speed mode based on the acceleration and deceleration times set at CON-68 (SPD/TRQAcc T) and CON-69 (SPD/TRQDec T).

If the terminal is on during a vector speed operation, where DRV-09 (Control Mode) is set to “5 (Vector)” and DRV-10 (Torque Control) is set to “0 (No)”, the operation switches from speed to torque mode.

8.17 Kinetic Energy Buffering

When the input power supply is disconnected, the inverter’s DC link voltage decreases, and a low voltage trip occurs, blocking the output. A kinetic energy buffering operation uses regenerative energy generated by the motor during the blackout to maintain the DC link voltage. This extends the time for a low voltage trip to occur after an instantaneous power interruption.

Group	Code	Name	LCD Display	Parameter Setting		Setting range	Unit
CON	77	Kinetic energy buffering selection	KEB Select	0	None	0-2	-
				1	KEB-1		
				2	KEB-2		
	78	Kinetic energy buffering start level	KEB Start Lev	130		110-200	%
	79	Kinetic energy buffering	KEB Stop	135		130-210	%

Learning Advanced Features

Group	Code	Name	LCD Display	Parameter Setting		Setting range	Unit
		stop level	Lev				
	86	Kinetic energy buffering P-Gain	KEB P Gain	1500		0–20000	%
	87	Kinetic energy buffering I gain	KEB I Gain	500		1–20000	%
	88	Kinetic energy buffering slip gain	KEB Slip Gain	30.0		0–2000.0	%
	89	Kinetic energy buffering acceleration time	KEB Acc Time	10.0		0.0–600.0	Sec
IN	65–75	PX terminal setting option	Px Define	50	KEB-1 Select	0–51	

Kinetic Energy Buffering Operation Setting Details

Code	Description					
CON-77 KEB Select	Select the kinetic energy buffering operation when the input power is disconnected.					
	<p>Note</p> <p>If a multi-function terminal is set to "50 (KEB-1 Select)", KEB operation is available via terminal input only. Set CON-77 to "0 (none)" in this case.</p>					
	<table border="1"> <thead> <tr> <th>Setting</th> <th>Function</th> </tr> </thead> <tbody> <tr> <td>0 None</td> <td>General deceleration is carried out until a low voltage trip occurs.</td> </tr> <tr> <td>1 KEB-1</td> <td> <p>If input power failure occurs, the inverter output frequency is controlled and the regeneration energy from the motor is charged by the inverter. Normal operation is resumed when the power is supplied again, using the acceleration time set at CON-89 (KEB Acc Time).</p> </td> </tr> </tbody> </table>	Setting	Function	0 None	General deceleration is carried out until a low voltage trip occurs.	1 KEB-1
Setting	Function					
0 None	General deceleration is carried out until a low voltage trip occurs.					
1 KEB-1	<p>If input power failure occurs, the inverter output frequency is controlled and the regeneration energy from the motor is charged by the inverter. Normal operation is resumed when the power is supplied again, using the acceleration time set at CON-89 (KEB Acc Time).</p>					

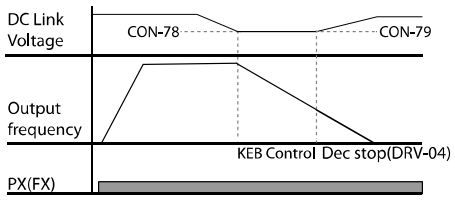
Code	Description
	<p data-bbox="453 287 968 414">If input power failure occurs, the inverter output frequency is controlled and the regeneration energy from the motor is charged by the inverter. The motor decelerates and stops when the power is supplied again, using the deceleration time set at DRV-04 (Dec Time).</p> 
<p>CON-78 KEB Start Lev, CON-79 KEB Stop Lev</p>	<p>Sets the start and stop points of the kinetic energy buffering operation. The set values must be based on the low voltage trip level at 100%, and the stop level (CON-79) must be set higher than the start level (CON-78).</p>
<p>CON-86 KEB P Gain</p>	<p>Used to maintain the voltage during the kinetic energy buffering operation. It operates the inverter by modifying the set value to prevent malfunctions caused by low voltage after power interruptions.</p>
<p>CON-87 KEB I Gain</p>	<p>Used to maintain the voltage during the kinetic energy buffering operation. Sets the gain value to maintain the operation until the frequency stops during the kinetic energy buffering operation.</p>
<p>CON-88 KEB Slip Gain</p>	<p>Used to prevent malfunctions caused by low voltage from initial kinetic energy buffering occurring due to power interruptions.</p>
<p>CON-89 KEB Acc Time</p>	<p>Sets the acceleration time for the frequency reference when the inverter's operation becomes normal after the kinetic energy buffering operation.</p>
<p>IN-65-75 Px Define</p>	<p>Sets a multi-function input Px to "50 (KEB-1 Select)". If the terminal is on during an operation, the inverter operates in KEB-1 mode. The inverter output frequency is controlled to the output level set at CON-78 and the regeneration energy from the motor is charged by the inverter. Normal operation is resumed when the power is supplied again, using the acceleration time set at CON-89 (KEB Acc Time). If the terminal is not on, KEB operation does not start when the input power failure occurs.</p> <p>If a multi-function terminal is set to "50 (KEB-1 Select)", KEB operation is available via terminal input only. Set CON-77 to "0 (none)" in this case.</p>

Code	Description

⚠ Caution

- Depending on the duration of instantaneous power interruptions and the amount of load inertia, a low voltage trip may occur even during a kinetic energy buffering operation.
- Motors may vibrate during kinetic energy buffering operation for some loads, except for variable torque loads (for example, fan or pump loads).

8.18 Energy Saving Operation

8.18.1 Manual Energy Saving Operation

If the inverter output current is lower than the current set at BAS-14 (NoLoad Curr), the output voltage must be reduced as low as the level set at ADV-51 (Energy Save). The voltage before the energy saving operation starts will become the base value of the percentage. The manual energy saving operation will not be carried out during acceleration and deceleration.

Group	Code	Name	LCD Display	Parameter Setting		Setting Range		Unit
ADV	50	Energy saving operation	E-Save Mode	1	Manual	0	None	-
						1	Manual	
						2	Auto	
	51	Energy saving amount	Energy Save	30		0-30	%	

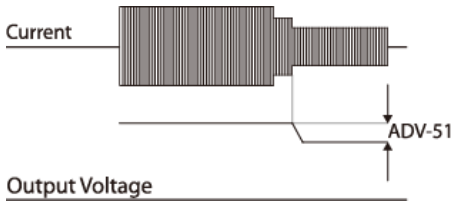

8.18.2 Automatic Energy Saving Operation

The inverter automatically finds the optimal energy saving point based on the motor rated current (BAS-13) and the no-load current (BAS-14).

Group	Code	Name	LCD Display	Setting		Setting Range	Unit
ADV	50	Energy saving operation	E-Save Mode	2	Auto	0-2	-
BAS	13	Motor-rated current	Rated Curr	Depends on inverter capacity		1-1000	A
	14	Motor no-load current	Noload Curr	Depends on inverter capacity		0.5-1000	A

⚠ Caution

If the operation frequency is changed, or acceleration or deceleration is carried out during an energy saving operation, the actual acc/dec time may take longer than the set time due to the time required to return to general operations from the energy saving operation.



8.19 Speed Search Operation

Speed search operation is used to prevent fault trips that can occur when the inverter voltage output is disconnected and the motor is idling. Since this feature estimates the motor rotation speed based on the inverter output current, it does not give the exact speed.

Group	Code	Name	LCD Display	Parameter Setting		Setting Range	Unit
CON	70	Speed search mode selection	SS Mode	0	Flying Start-1	-	-
	71	Speed search operation selection	Speed Search	0000		-	bit
	72	Speed search reference current	SS Sup-Current	Up to 75 kW	150	80-200	%
				Over 75 kW	100		
	73	Speed search proportional gain	SS P-Gain	100		0-9999	-
	74	Speed search integral gain	SS I-Gain	200		0-9999	-
75	Output block time before speed search	SS Block Time	1.0		0-60	sec	
OUT	31-32	Multi-function relay 1-2	Relay 1-2	19	Speed Search	-	-
	33	Multi-function output 1	Q1 Define				

Speed Search Operation Setting Details

Code	Description	
CON-70 SS Mode	Select a speed search type.	
	Setting	Function
	0	Flying Start-1
		The speed search is carried out as it controls the inverter output current during idling below the CON-72 (SS Sup-Current) parameter setting. If the direction of the idling motor and the direction of the operation command at restart are the same, a stable speed search function can be performed at about 10

Code	Description			
		Hz or lower. However, if the direction of the idling motor and the direction of the operation command at restart are different, the speed search does not produce a satisfactory result because the direction of idling cannot be established.		
	1 Flying Start-2	The speed search is carried out by the PI controller, which controls the ripple current generated by the counter electromotive force during no-load rotation. As this mode establishes the direction of the idling motor (forward/reverse), the speed search function is stable regardless of the direction of the idling motor and direction of the operation command. However, because the ripple current is used, which is generated by the counter electromotive force while idling (the counter electromotive force is proportional to the idle speed), the idle frequency is not determined accurately and re-acceleration may start from zero speed when the speed search is performed for the idling motor at a low speed (about 10 - 15 Hz, though it depends on motor characteristics).		
CON-71 Speed Search	Speed search can be selected from the following four options. If the top display segment is on, it is enabled (On). If the bottom segment is on, it is disabled (Off).			
	Item	Bit Setting On Status	Bit Setting Off Status	
	Keypad			
	Type and Functions of Speed Search Setting			
Setting				Function
bit4	bit3	bit2	bit1	
			✓	Speed search for general acceleration
		✓		Initialization after a fault trip
	✓			Restart after instantaneous power interruption
✓				Start with power-on

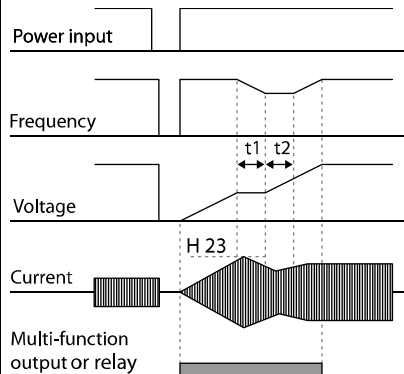
Code	Description
	<p>Speed search for general acceleration: If bit 1 is set to "1" and the inverter operation command runs, acceleration starts with the speed search operation. When the motor is rotating under load, a fault trip may occur if the operation command is run for the inverter to provide voltage output. The speed search function prevents such fault trips from occurring.</p> <p>Initialization after a fault trip other than an LV trip: If bit 2 is set to "1" and PRT-08 (RST Restart) is set to "1 (Yes)", the speed search operation automatically accelerates the motor to the operation frequency used before the fault trip when the [STOP/RESET] key is pressed (or the terminal block input is on) after a fault trip.</p> <p>Automatic restart after an instantaneous power interruption: If bit 3 is set to "1", and if a low voltage trip occurs due to a power interruption but the power is restored before the internal power shuts down, the speed search operation accelerates the motor back to its frequency reference before the low voltage trip.</p> <p>If an instantaneous power interruption occurs and the input power is disconnected, the inverter generates a low voltage trip and blocks the output. When the input power returns, the operation frequency before the low voltage trip and the voltage is increased by the inverter's inner PI controller.</p> <p>If the current increases above the value set at CON-72, the voltage stops increasing and the frequency decreases (t1 zone). If the current decreases below the value set at CON-72, the voltage increases again and the frequency stops decelerating (t2 zone). When the normal frequency and voltage are resumed, the speed search operation accelerates the motor back to its frequency reference before the fault trip.</p>  <p>The diagram consists of five vertically stacked waveforms. 1. Power input: Shows a pulse that drops to zero for a duration, then returns to its original level. 2. Frequency: Shows a step increase followed by a dip (labeled t1) and a subsequent rise (labeled t2) before returning to the step level. 3. Voltage: Shows a step increase followed by a dip (labeled t1) and a subsequent rise (labeled t2) before returning to the step level. 4. Current: Shows a pulse that rises to a peak labeled 'H 23', then falls and rises again. 5. Multi-function output or relay: Shows a pulse that occurs during the power interruption and restart period.</p>

Code	Description
	Starting with power-on: Set bit 4 to "1" and ADV-10 (Power-on Run) to "1 (Yes)". If inverter input power is supplied while the inverter operation command is on, the speed search operation will accelerate the motor up to the frequency reference.
CON-72 SS Sup-Current	The amount of current flow is controlled during speed search operation based on the motor's rated current. If CON-70 (SS mode) is set to "1 (Flying Start-2)", this code is not visible.
CON-73 SS P-Gain, CON-74 SS I-Gain	The P/I gain of the speed search controller can be adjusted. If CON-70 (SS Mode) is set to "1"(Flying Start-2), different factory defaults based on motor capacity [at DRV-14 (Motor Capacity)] are used.
CON-75 SS Block Time	The block time parameter prevents overvoltage trips due to counter electromotive force by cutting off the inverter output for the set time before carrying out a speed search.

Note

- If operated within the rated output, the iS7 series inverter is designed to withstand instantaneous power interruptions of up to 15 ms and maintain normal operation [when 200–230 V AC input voltage is supplied to 200 V class model types, and 380–460 V AC input voltage is supplied to 400 V class model types, and when the inverter is operating with static load current (CT load)].
- The DC voltage inside the inverter changes depending on the load. Low voltage fault trips may result if the power interruption lasts longer than 15 ms, or the output voltage exceeds the rated input voltage.

8.20 Auto Restart Settings

When inverter operation stops due to a fault and a fault trip is activated, the inverter automatically restarts based on the parameter settings.

Group	Code	Name	LCD Display	Parameter Setting		Setting Range	Unit
PRT	08	Select start at trip reset	RST Restart	0	No	-	-
				1	Yes		
	09	Auto restart count	Retry Number	6		0–10	-

Group	Code	Name	LCD Display	Parameter Setting		Setting Range	Unit
	10	Auto restart delay time	Retry Delay	1.0		0.1–60.0	sec
CON	71	Select speed search operation	Speed Search	-		0000–1111	bit
	72	Speed search startup current	SS Sup-Current	Up to 75 kW	150	80–200	%
				Over 75 kW	100		
	73	Speed search proportional gain	SS P-Gain	100		0–9999	
	74	Speed search integral gain	SS I-Gain	200		0–9999	
	75	Output block time before speed search	SS Block Time	1.0		0.0–60.0	sec

Auto Restart Setting Details

Code	Description
PRT-08 RST Restart	Set PRT-08 to “1 (Yes)” to enable reset restart.
PRT-09 Retry Number, PRT-10 Retry Delay	<p>The number of available auto restarts can be set at PRT-09. If a fault trip occurs during an operation, the inverter restarts after the time set at PRT-10 (Retry Delay). At each restart, the inverter counts the number of tries and subtracts it from the number set at PRT-09 until the retry number count reaches 0. After an auto restart, if a fault trip does not occur within 60 sec, it will increase the restart count number. The maximum count number is limited by the number set at PRT-09.</p> <p>If the inverter stops due to low voltage, an emergency stop, an inverter overheating, or a hardware malfunction, auto restart is not activated.</p> <p>At auto restart, the acceleration options are identical to those of the speed search operation. Codes CON-72–75 can be set based on the load. For the speed search function details, refer to 8.19 Speed Search Operation on page 250.</p>

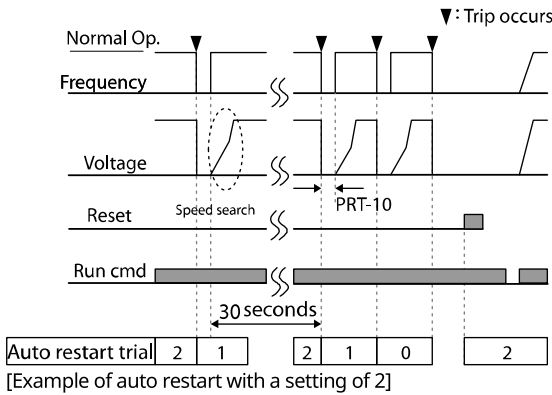

⚠ Caution

If the auto restart number is set, be careful when the inverter resets from a fault trip. The motor may automatically start to rotate.

8.21 Operational Noise Settings (Carrier Frequency Settings)

Group	Code	Name	LCD Display	Parameter Setting	Setting Range	Unit
CON	04	Carrier Frequency	Carrier Freq	5.0	0.7–15.0	kHz
	05	Switching Mode	PWM* Mode	0	Normal PWM / Low Leakage PWM	-

*PWM: Pulse width modulation

Operational Noise Setting Details

Code	Description
CON-04 Carrier Freq	Adjusts motor operational noise by changing carrier frequency settings. Power transistors (IGBT) in the inverter generate and supply high frequency switching voltage to the motor. The carrier frequency refers to the switching speed in this process. If the carrier frequency is set high, it reduces operational noise from the motor. If the carrier frequency is set low, it increases operational

Code	Description																												
	noise from the motor.																												
CON-05 PWM Mode	The heat loss and leakage current from the inverter can be reduced by changing the load rate option at CON-05 (PWM Mode). Selecting "1 (LowLeakage PWM)" reduces heat loss and leakage current, compared to when "0 (Normal PWM)" is selected. However, it increases the motor noise. Low leakage PWM uses a two-phase PWM modulation mode, which helps minimize degradation and reduces switching loss by approximately 30%.																												
	<table border="1"> <thead> <tr> <th rowspan="3">Item</th> <th colspan="2">Carrier Frequency</th> </tr> <tr> <th>0.7 kHz</th> <th>15 kHz</th> </tr> <tr> <th>LowLeakage PWM</th> <th>Normal PWM</th> </tr> </thead> <tbody> <tr> <td>Motor noise</td> <td>↑</td> <td>↓</td> </tr> <tr> <td>Motor temperature</td> <td>↑</td> <td>↓</td> </tr> <tr> <td>Inverter heat Loss</td> <td>↓</td> <td>↑</td> </tr> <tr> <td>High frequency</td> <td>↑</td> <td>↓</td> </tr> <tr> <td>Inverter output current wave form</td> <td>Bad</td> <td>Good</td> </tr> <tr> <td>Inverter noise</td> <td>↓</td> <td>↑</td> </tr> <tr> <td>Inverter leakage current</td> <td>↓</td> <td>↑</td> </tr> </tbody> </table>	Item	Carrier Frequency		0.7 kHz	15 kHz	LowLeakage PWM	Normal PWM	Motor noise	↑	↓	Motor temperature	↑	↓	Inverter heat Loss	↓	↑	High frequency	↑	↓	Inverter output current wave form	Bad	Good	Inverter noise	↓	↑	Inverter leakage current	↓	↑
	Item		Carrier Frequency																										
			0.7 kHz	15 kHz																									
		LowLeakage PWM	Normal PWM																										
	Motor noise	↑	↓																										
	Motor temperature	↑	↓																										
	Inverter heat Loss	↓	↑																										
	High frequency	↑	↓																										
Inverter output current wave form	Bad	Good																											
Inverter noise	↓	↑																											
Inverter leakage current	↓	↑																											

⚠ Caution

- The factory default carrier frequency for 90–160 kW model types is **3 kHz**. The figure in the red box (D: 5.0) is a factory default carrier frequency for models types up to 75 kW, provided for your reference only.

PAR	CON	N	STP	0.00 Hz
04 Carrier Freq				
3. kHz				
0.7 ~ 6.0 kHz				
G:3.0				
D:5.0				

- Since low carrier frequencies can transmit a much higher frequency than the capacity of the output current, an increase in motor loss will occur. Some motors may stall due to increased high frequency current and lack of torque may cause the inverter to stop.

Note

- **Factory default carrier frequency by model types**

0.75–22 kW	30–45 kW	55–75 kW	90–110 kW	132–160 kW
5 kHz (15 kHz max.)	5 kHz (10 kHz max.)	5 kHz (7 kHz max.)	3 kHz (6 kHz max.)	3 kHz (5 kHz max.)

- **iS7 Series Inverter Derating Standard (Derating):** The overload rate represents an acceptable load amount that exceeds the rated load, and is expressed as a ratio based on the rated load and the duration. The overload capacity on the iS7 series inverter is 110%/1 min for normal loads.
- The current rating differs by load types, and it also has an ambient temperature limit.
- **Current derating for ambient temperature at variable torque (VT) load operation:**

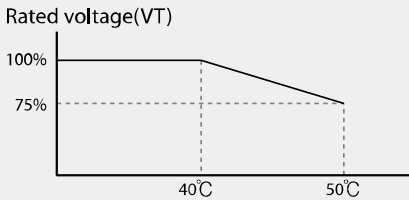

- **Current derating table by ambient temperature and carrier frequency:**

Inverter Capacity		0.75–7.5kW	11–22kW	30–75kW
CT Load	Normal Temp. (25°C)	10 kHz	10 kHz	5 kHz
	High Temp. (40°C)	7 kHz	7 kHz	4 kHz
	High Temp. (50°C)	5 kHz	5 kHz	4 kHz
VT Load	Normal Temp. (25°C)	7 kHz	7 kHz	3 kHz
	High Temp. (40°C)	2 kHz	2 kHz	2 kHz

8.22 2nd Motor Operation

The 2nd motor operation is used when a single inverter switch operates two motors. Using the 2nd motor operation, a parameter for the second motor is set. The second motor operates when a multi-function terminal input defined as a second motor function is turned on.

Group	Code	Name	LCD Display	Parameter Setting		Setting Range	Unit
IN	65-75	Px terminal configuration	Px Define(Px: P1-P8 [optional: P9-P11])	26	2nd Motor	-	-
M2	04	2nd motor acceleration time	M2-Acc Time	-	5.0	0-600	sec

2nd Motor Operation Setting Details

Code	Description
IN-65-75 Px Define	<p>Set one of the multi-function input terminals (P1-P11) to "26 (2nd Motor)" to display the M2 (2nd motor group) group. An input signal sent to a multi-function terminal set as the second motor will operate the motor according to the code settings listed below. However, if the inverter is in operation, input signals to the multi-function terminals will not read as a second motor parameter.</p> <ul style="list-style-type: none"> You can set the 2nd motor control mode at M2-08 (M2-Ctrl Mode). V/F PG and Vector control modes are not supported with the 2nd motor operation. PRT-50 (Stall Prevent) must be set first, before M2-28 (M2-Stall Lev) settings can be used. PRT-40 (ETH Trip Sel) must be set first, before M2-29 (M2-ETH 1 min) and M2-30 (M2-ETH Cont) settings can be used.

Parameter Setting at Multi-function Terminal Input on a Second Motor

Code	Description	Code	Description
M2-04 Acc Time	Acceleration time	M2-15 M2-Efficiency	Motor efficiency
M2-05 M2-Dec Time	Deceleration time	M2-17 M2-Rs	Stator resistance
M2-06 M2-Capacity	Motor capacity	M2-18 M2-Lsigma	Leakage inductance
M2-07 M2-Base Freq	Motor base frequency	M2-25 M2-V/F Patt	V/F pattern
M2-08 M2-Ctrl Mode	Control mode	M2-26 M2-Fwd Boost	Forward torque boost

Code	Description	Code	Description
M2-10 M2-Pole Num	Pole number	M2-27 M2-Rev Boost	Reverse torque boost
M2-11 M2-Rate Slip	Rated slip	M2-28 M2-Stall Lev	Stall prevention level
M2-12 M2-Rated Curr	Rated current	M2-29 M2-ETH 1 min	Motor heat protection 1 min rating
M2-13 M2-Noload Curr	No-load current	M2-30 M2-ETH Cont	Motor heat protection continuous rating
M2-14 M2-Rated Volt	Motor-rated voltage		

Example - 2nd Motor Operation

Use the 2nd motor operation when switching operations between a 7.5 kW motor and a secondary 3.7 kW motor using terminal P3. Refer to the following settings.

Group	Code	Name	LCD Display	Parameter Setting		Setting Range	Unit
IN	67	Terminal P3 configuration	P3 Define	26	2nd Motor	-	-
M2	06	Motor capacity	M2-Capacity	-	3.7 kW	-	-
	08	Control mode	M2-Ctrl Mode	0	V/F	-	-

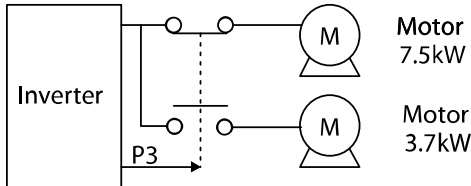

8.23 Supply Power Transition

A supply power transition is used to switch the power source for the motor connected to the inverter from the inverter output power to the main supply power source (commercial power source), or vice versa.

Group	Code	Name	LCD Display	Parameter Setting		Setting Range	Unit
IN	65–75	Px terminal configuration	Px Define (Px: P1–P8 [optional: P9–P11])	16	Exchange	-	-
OUT	31–32	Multi-function relay 1–2	Relay1–2	17	Inverter Line	-	-
	33	Multi-function output 1	Q1 Define	18	Comm Line	-	-

Supply Power Transition Setting Details

Code	Description
IN-65-75 Px Define	When the motor power source changes from the inverter output to the main power supply, select a terminal to use and set the code value to "16 (Exchange)". Power will be switched when the selected terminal is on. To reverse the transition, switch off the terminal.
OUT-31 Relay 1, OUT-32 Relay 2, OUT-33 Q1 Define	<p>Set the multi-function relay or multi-function output to "17 (Inverter Line)" or "18 (Comm Line)". The relay operation sequence is as follows.</p>

8.24 Cooling Fan Control

This function turns the inverter's heatsink cooling fan on and off. It is used in situations where the load stops and starts frequently or when a noise-free environment is required. The correct use of cooling fan controls can extend the cooling fan's life.

Group	Code	Name	LCD Display	Parameter Setting	Setting Range	Unit	
ADV	64	Cooling fan control	Fan Control	0	During Run	0-2	-
				1	Always On		
				2	Temp Control		

Cooling Fan Control Detail Settings

Code		Description	
ADV-64 Fan Control	Settings		Description
	0	During Run	The cooling fan runs when the power is supplied to the inverter and the operation command is on. The cooling fan stops when the power is supplied to the inverter and the operation command is off. When the inverter heat sink temperature is higher than its set value, the cooling fan operates automatically regardless of its operation status.
	1	Always On	The cooling fan runs constantly if power is supplied to the inverter.
	2	Temp Control	With power connected and the run operation command on: if the setting is in Temp Control, the cooling fan will not operate unless the temperature in the heat sink reaches the set temperature.

Note

In 11–75 kW model types, if the heat sink temperature reaches a set level by input current harmonic waves or noise, the cooling fan may run to protect the inverter even when ADV-64 is set to “0 (During Run)”.

8.25 Input Power Frequency Settings

Select the frequency for inverter input power. If the frequency changes from 60 Hz to 50 Hz, all other frequency (or RPM) settings, including the maximum frequency, base frequency, etc., will change to 50 Hz. Likewise, changing the input power frequency setting from 50 Hz to 60 Hz will change all related function item settings from 50 Hz to 60 Hz.

Group	Code	Name	LCD Display	Parameter Setting		Setting Range	Unit
BAS	10	Input power frequency	60/50 Hz Sel	0	60 Hz	0–1	-

8.26 Input Power Voltage Settings

Set the inverter input power voltage. The low voltage fault trip level changes automatically according to the set voltage standard.

Group	Code	Name	LCD Display	Parameter Setting		Setting Range	Unit
BAS	19	Input power voltage	AC Input Volt	200 Type	220	170–230	V
				400 Type	380	380–480	

8.27 Read, Write, and Save Parameters

Use read, write, and save parameter functions to copy parameters from the inverter to the keypad or from the keypad to the inverter.

Group	Code	Name	LCD Display	Parameter Setting		Setting Range	Unit
CNF	46	Parameter read	Parameter Read	1	Yes	-	-
	47	Parameter write	Parameter Write	1	Yes	-	-
	48	Parameter save	Parameter Save	1	Yes	-	-

Read, Write, and Save Parameter Setting Details

Code	Description
CNF-46 Parameter Read	Copies saved parameters from the inverter to the keypad. Saved parameters on the keypad will be deleted and replaced with the copied parameters.
CNF-47 Parameter Write	Copies saved parameters from the keypad to the inverter. Saved parameters on the inverter will be deleted and replaced with the copied parameters. If an error occurs during parameter writing, the previously saved data will be used. If there is no saved data on the keypad, "EEP Rom Empty" will be displayed.
CNF-48 Parameter Save	As parameters set during communication transmission are saved in RAM, the setting values will be lost if the power turns off and on. When setting parameters during communication transmission, select "1 (Yes)" at CNF-48 to save the set parameters.

Caution 

When utilizing the optional communication module, note the following information if you need to read or write the parameter values set at COM-10-25 (Opt Parameter).

1. Because the “Opt Parameter” (COM-10-25) values are stored in the optional add-on module, you must run “Comm Update” (COM-94) to apply the changes after making changes to the parameter settings.
2. You must save the parameter values set at COM-10-25 (Opt Parameter) by running “Parameter Save” before you can read or write the “Opt Parameter” parameters.

8.28 Parameter Initialization

User changes to parameters can be initialized (reset) to factory default settings on all or selected groups. Parameters cannot be reset during operation or a fault trip condition.

Group	Code	Name	LCD Display	Parameter Setting		Setting Range	Unit
CNF	40	Parameter initialization	Parameter Init	0	No	0-15	

Parameter Initialization Setting Details

Code	Description			
CNF-40 Parameter Init	Setting		LCD Display	Function
	0	No	No	-
	1	Initialize all groups	All Grp	Initialize all data. Select “1 (All Grp)” and press the [PROG/ENT] key to start initialization. On completion, “0 (No)” will be displayed.
	2	Initialize DRV group	DRV Grp	Initialize data by groups. Select Initialize group and press the [PROG/ENT] key to start initialization. On completion, “0 (No)” will be displayed.
	3	Initialize BAS group	BAS Grp	
	4	Initialize ADV group	ADV Grp	
	5	Initialize CON group	CON Grp	
	6	Initialize IN group	IN Grp	
7	Initialize OUT group	OUT Grp		

Code	Description		
	8	Initialize COM group	COM Grp
	9	Initialize APP group	APP Grp
	10	Initialize AUT group	AUT Grp
	11	Initialize APO group	APO Grp
	12	Initialize PRT group	PRT Grp
	13	Initialize M2 group	M2 Grp

8.29 Parameter Viewing and Lock Options

8.29.1 Parameter View Lock

Use parameter view lock to hide parameter mode (PAR mode) after registering and entering a user password. Other modes (CNF, U&M, MAC and TRP modes) will still be visible when the parameter view lock is enabled.

Group	Code	Name	LCD Display	Parameter Setting	Setting Range	Unit
CNF	50	Parameter view lock	View Lock Set	Unlocked	0-9999	-
	51	Parameter view lock password	View Lock Pw	Password	0-9999	-

Parameter View Lock Setting Details

Code	Description												
CNF-51 View Lock Pw	Register a password to allow access to parameter view lock. Follow the steps below to register a password.												
	<table border="1"> <thead> <tr> <th>No</th> <th>Procedure</th> </tr> </thead> <tbody> <tr> <td>1</td> <td>Press the [PROG/ENT] key on code CNF-51 to show the previous password input window. If a password is being registered for the first time, enter "0". It is the factory default.</td> </tr> <tr> <td>2</td> <td>If a password had been set, enter the saved password.</td> </tr> <tr> <td>3</td> <td>If the entered password matches the saved password, a new window prompting the user to enter a new password will be displayed (the process will not progress to the next stage until the user enters a valid password).</td> </tr> <tr> <td>4</td> <td>Register a new password.</td> </tr> <tr> <td>5</td> <td>After registration, code CNF-51 (View Lock PW) will be displayed.</td> </tr> </tbody> </table>	No	Procedure	1	Press the [PROG/ENT] key on code CNF-51 to show the previous password input window. If a password is being registered for the first time, enter "0". It is the factory default.	2	If a password had been set, enter the saved password.	3	If the entered password matches the saved password, a new window prompting the user to enter a new password will be displayed (the process will not progress to the next stage until the user enters a valid password).	4	Register a new password.	5	After registration, code CNF-51 (View Lock PW) will be displayed.
	No	Procedure											
	1	Press the [PROG/ENT] key on code CNF-51 to show the previous password input window. If a password is being registered for the first time, enter "0". It is the factory default.											
	2	If a password had been set, enter the saved password.											
	3	If the entered password matches the saved password, a new window prompting the user to enter a new password will be displayed (the process will not progress to the next stage until the user enters a valid password).											
4	Register a new password.												
5	After registration, code CNF-51 (View Lock PW) will be displayed.												
CNF-50 View Lock Set	To enable parameter view lock, enter a registered password. The [Locked] sign will be displayed on the screen to indicate that parameter view lock is enabled. To disable parameter view lock, re-enter the password. The [locked] sign will disappear, and PAR mode becomes visible again.												

8.29.2 Parameter Lock

Use parameter lock to prevent unauthorized modification of parameter settings. To enable parameter lock, register and enter a user password first.

Group	Code	Name	LCD Display	Parameter Setting	Setting Range	Unit
CNF	52	Parameter lock	Key Lock Set	Unlocked	0-9999	-
	53	Parameter lock password	Key Lock Pw	Password	0-9999	-

Parameter Lock Setting Details

Code	Description	
CNF-53 Key Lock PW	Register a password to prohibit parameter modifications. Follow the procedures below to register a password.	
	No	Procedures
	1	Press the [PROG/ENT] key on code CNF-53 to display the saved password input window. If a password is being registered for the first time, enter "0". It is the factory default.
	2	If a saved password has been set, enter the saved password.
	3	If the entered password matches the saved password, then a new window to enter a new password will be displayed. (The process will not progress to the next stage until the user enters a valid password).
	4	Register a new password.
5	After registration, code CNF-53 will be displayed.	
CNF-52 Key Lock Set	To enable parameter lock, enter the registered password. The [Locked] sign will be displayed on the screen to indicate that prohibition is enabled. Once enabled, pressing the [PROG/ENT] key will not allow the edit mode to run. To disable parameter lock, re-enter the password. The [Locked] sign will disappear.	

⚠ Caution

If parameter view lock and parameter lock functions are enabled, no inverter operation related function changes can be made. It is very important that you memorize the password.

8.29.3 Changed Parameter Display

This feature displays all the parameters that are different from the factory defaults. Use this feature to track changed parameters.

Group	Code	Name	LCD Display	Parameter Setting	Setting Range	Unit
CNF	41	Changed parameter display	Changed Para	1 View Changed	-	-

Changed Parameter Display Setting Details

Code	Description		
CNF-41 Changed Para	Setting		Function
	0	View All	Display all parameters
	1	View Changed	Display changed parameters only



8.30 User Group

Create a user-defined group and register user-selected parameters from the existing function groups. The user group can carry up to a maximum of 64 parameter registrations.

Group	Code	Name	LCD Display	Parameter Setting	Setting Range	Unit
CNF	42	Multi-function key settings	Multi Key Sel	3 UserGrp SelKey	-	-
	45	Delete all user registered codes	UserGrp AllDel	0 No	-	-

User Group Setting Details

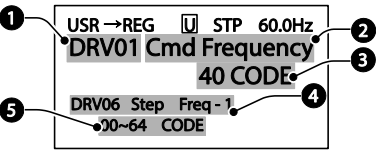
Code	Description
CNF-42 Multi Key Sel	Selects "3 (UserGrp SelKey)" from the multi-function key setting options. If user group parameters are not registered, setting the multi-function key to the user group select key (UserGrp SelKey) will not display user group (USR Grp) items on the keypad.

Code	Description
Follow the procedures below to register parameters to a user group.	
No	Procedure
1	Set CNF- 42 to "3 (UserGrp SelKey)". The  icon will be displayed at the top of the LCD display.
2	<p>In the parameter mode (PAR Mode), move to the parameter you need to register and press the [MULTI] key. For example, if the [MULTI] key is pressed in the frequency reference in DRV-01 (Cmd Frequency), the screen below will be displayed.</p>  <ul style="list-style-type: none"> ❶ Group name and code number of the parameter. ❷ Name of the parameter. ❸ Code number to be used in the user group. Pressing the [PROG/ENT] key on the code number (40 Code) will register DRV-01 as code 40 in the user group. ❹ Existing parameter registered as the user group code 40. ❺ Setting range of the user group code. Entering "0" cancels the settings.
3	❸ Set a code number to use to register the parameter in the user group. Select the code number and press the [PROG/ENT] key.
4	Changing the value in ❸ will also change the value in ❹. If no code is registered, "Empty Code" will be displayed. Entering "0" cancels the settings.
5	The registered parameters are listed in the user group in U&M mode. You can register one parameter multiple times if necessary. For example, a parameter can be registered as code 2, code 11, etc. in the user group.
Follow the procedures below to delete parameters in the user group.	
No.	Settings
1	Set CNF- 42 to "3 (UserGrp SelKey)". The  icon will be displayed at the top of the LCD display.

Code	Description	
	2	In the USR group in U&M mode, move the cursor to the code that is to be deleted.
	3	Press the [MULTI] key.
	4	Select "YES" on the deletion confirmation screen, and press the [PROG/ENT] key.
	5	The parameter is deleted.
CNF-25 UserGrp AllDel	Set to "1 (Yes)" to delete all registered parameters in the user group.	

8.31 Macro Selection

The macro selection function is used to put various application functions together in a group. For applications with the iS7 series inverters, two basic macro configurations for "Draw"* and "Traverse" applications (MC1 and MC2) are currently available in U&M mode. Macro functions cannot be added by the user, but the data can be modified.

Group	Code	Name	LCD Display	Parameter Setting		Setting Range	Unit
CNF	43	Macro selection	Macro Select	0	None	0-2	-
				1	Draw		
				2	Traverse		

*The draw application is an open loop tension control which maintains a stable tension load applied to the material by utilizing the difference between the main reference and the auxiliary reference (Refer to [8.1 Operating with Auxiliary References](#) on page 196 for details).

Macro Selection Details

Code	Description
CNF-43 Macro Select	A list of macro settings is displayed for user selection. When a macro function is selected, all the related parameters are automatically changed based on the inverter's macro settings.

8.32 Easy Start

Run Easy Start to easily set up the basic motor parameters required to operate a motor in a batch. Set CNF-61 (Easy Start On) to "1 (Yes)" to activate the feature, initialize all parameters by setting CNF-40 (Parameter Init) to "1 (All Grp)", and restart the inverter to activate Easy Start.

Group	Code	Name	LCD Display	Parameter Setting	Setting Range	Unit
CNF	61	Parameter easy start settings	Easy Start On	1 Yes	-	-

Easy Start Setting Details

Code	Description								
CNF-61 Easy Start On	Follow the procedures listed below to set the Easy Start parameters.								
	<table border="1"> <thead> <tr> <th>No</th> <th>Procedures</th> </tr> </thead> <tbody> <tr> <td>1</td> <td>Set CNF-61 (Easy Start On) to "1 (Yes)".</td> </tr> <tr> <td>2</td> <td>Set CNF-40 (Parameter Init) to "1 (All Grp)" to initialize all parameters in the inverter.</td> </tr> <tr> <td>3</td> <td> <p>Restarting the inverter will activate Easy Start. Set the values in the following screens on the keypad. To exit Easy Start, press the [ESC] key.</p> <p>Start Easy Set: Select "Yes". CNF-01 Language Sel: Select a language. DRV-30 kW/HP Select : select the capacity of the unit. DRV-14 Motor Capacity: Set motor capacity. BAS-11 Pole Number: Set motor pole number. BAS-15 Rated Volt: Set motor rated voltage. BAS-10 60/50 Hz Sel: Set motor rated frequency. BAS-19 AC Input Volt: Set input voltage. DRV-06 Cmd Source: Set command source. DRV-01 Cmd Frequency: Set frequency reference.</p> <p>When the settings are complete, the minimum parameter settings on the motor have been made. The keypad will return to a monitoring display. Now the motor can be operated with the command source set at DRV-06.</p> </td> </tr> </tbody> </table>	No	Procedures	1	Set CNF-61 (Easy Start On) to "1 (Yes)".	2	Set CNF-40 (Parameter Init) to "1 (All Grp)" to initialize all parameters in the inverter.	3	<p>Restarting the inverter will activate Easy Start. Set the values in the following screens on the keypad. To exit Easy Start, press the [ESC] key.</p> <p>Start Easy Set: Select "Yes". CNF-01 Language Sel: Select a language. DRV-30 kW/HP Select : select the capacity of the unit. DRV-14 Motor Capacity: Set motor capacity. BAS-11 Pole Number: Set motor pole number. BAS-15 Rated Volt: Set motor rated voltage. BAS-10 60/50 Hz Sel: Set motor rated frequency. BAS-19 AC Input Volt: Set input voltage. DRV-06 Cmd Source: Set command source. DRV-01 Cmd Frequency: Set frequency reference.</p> <p>When the settings are complete, the minimum parameter settings on the motor have been made. The keypad will return to a monitoring display. Now the motor can be operated with the command source set at DRV-06.</p>
	No	Procedures							
	1	Set CNF-61 (Easy Start On) to "1 (Yes)".							
2	Set CNF-40 (Parameter Init) to "1 (All Grp)" to initialize all parameters in the inverter.								
3	<p>Restarting the inverter will activate Easy Start. Set the values in the following screens on the keypad. To exit Easy Start, press the [ESC] key.</p> <p>Start Easy Set: Select "Yes". CNF-01 Language Sel: Select a language. DRV-30 kW/HP Select : select the capacity of the unit. DRV-14 Motor Capacity: Set motor capacity. BAS-11 Pole Number: Set motor pole number. BAS-15 Rated Volt: Set motor rated voltage. BAS-10 60/50 Hz Sel: Set motor rated frequency. BAS-19 AC Input Volt: Set input voltage. DRV-06 Cmd Source: Set command source. DRV-01 Cmd Frequency: Set frequency reference.</p> <p>When the settings are complete, the minimum parameter settings on the motor have been made. The keypad will return to a monitoring display. Now the motor can be operated with the command source set at DRV-06.</p>								

8.33 Config (CNF) Mode

The config mode parameters are used to configure keypad-related features.

Group	Code	Name	LCD Display	Parameter Setting		Setting Range	Unit
CNF*	2	LCD brightness/ contrast adjustment	LCD Contrast	-		-	
	10	Inverter S/W version	Inv S/W Ver	x.xx		-	
	11	Keypad S/W version	Keypad S/W Ver	x.xx		-	-
	12	Keypad title version	KPD Title Ver	x.xx		-	-
	30–32	Power slot type	Option-x Type	None		-	-
	41	Display changed parameters	Changed Para	0	View All	0–1	-
	44	Erase trip history	Erase All Trip	No		-	-
	60	Add title update	Add Title Up	No		-	-
	62	Initialize accumulated electrical energy	WH Count Reset	No		-	-
	74	Accumulated cooling fan operation time	Fan Time	0000DAY 00:00			
	75	Accumulated cooling fan operation time initialization	Fan Time Rst	0	No		

Config Mode Parameter Setting Details

Code	Description
CNF-2 LCD Contrast	Adjusts LCD brightness/contrast on the keypad.
CNF-10 Inv S/W Ver, CNF-11 Keypad S/W Ver	Checks the OS version in the inverter and on the keypad.
CNF-12 KPD Title Ver	Checks the title version on the keypad.
CNF-30–32 Option-x Type	Checks the type of option board installed in the option slot.
CNF-41 Changed Para	Displays all the parameters that are different from the factory defaults.
CNF-44 Erase All Trip	Deletes the stored trip history.

Code	Description
CNF-60 Add Title UP	When the inverter SW version is updated and more code is added, CNF-60 settings will add, display, and operate the added codes. Set CNF-60 to "1 (Yes)" and disconnect the keypad from the inverter. Reconnecting the keypad to the inverter updates titles.
CNF-62 WH Count Reset	Initialize the accumulated electrical energy consumption count.
CNF-74 Fan Time	Displays the accumulated cooling fan operation time.
CNF-75 Fan Time Rst	Initialize the accumulated cooling fan operation time at CNF-74.

8.34 Timer Settings

Set a multi-function input terminal to a timer and set the On/Off controls to the multi-function outputs and relays according to the timer settings.

Group	Code	Name	LCD Display	Parameter Setting		Setting Range	Unit
IN	65–75	Px terminal configuration	Px Define (Px: P1–P8 [optional: P9–P11])	38	Timer In	-	-
OUT	31	Multi-function relay 1	Relay 1	28	Timer Out	-	sec
	33	Multi-function output 1	Q1 Define				
	55	Timer on delay	TimerOn Delay	0.00		0.00–100.00	sec
	56	Timer off delay	TimerOff Delay	0.00		0.00–100.00	sec

Timer Setting Details

Code	Description
IN-65–75 Px Define	Selects one of the multi-function input terminals and change it to a timer terminal by setting it to "38 (Timer In)".
OUT-31 Relay 1, OUT-36 Q1 Define	Sets the multi-function output terminal or relay to be used as a timer to "28 (Timer out)".
OUT-55 TimerOn Delay, OUT-56 TimerOff Delay	Inputs a signal (On) to the timer terminal to operate a timer output (Timer out) after the time set at OUT-55 has passed. When the multi-function input terminal is off, the multi-function output or relay turns off after the time set at OUT-56.

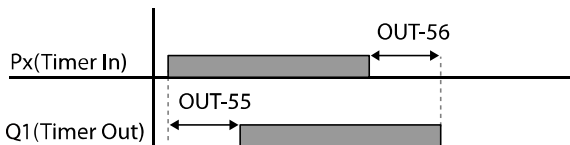

8.35 Traverse Operation

The traverse operation is used to periodically change the motor rotation. In its application as a winder, the traverse operation ensures that the thread or wire is evenly wound on a spindle without tangles.

Group	Code	Name	LCD Display	Parameter Setting		Setting Range	Unit
APP	01	Applied function selection	App Mode	1	Traverse	0–4	-
	08	Traverse operating range	Trv Amplit %	-	0.0	0–20	%
	09	Traverse scramble magnitude	Trv Scramb %	-	0.0	0–50	%
	10	Traverse acceleration time	Trv Acc Time	-	2.0	0.1–600.0	Sec
	11	Traverse deceleration time	Trv Dec Time	-	3.0	0.1–600.0	Sec
	12	Traverse offset upper limit	Trv Offset Hi	-	0.0	0–20.0	%
	13	Traverse offset lower limit	Trv Offset Lo	-	0.0	0–20.0	%
IN	65–75	Px terminal configuration	Px Define (Px: P1–P8 [optional: P9–P11])	27	Trv Offset Lo	-	-
				28	Trv Offset Hi	-	-

Traverse Operation Details

Code	Description												
APP-01 APP Mode	Set APP-01 to "1 (Traverse)". Parameters for the traverse operation become visible. <table border="1" style="margin-left: 20px;"> <thead> <tr> <th>Setting</th> <th>Function mode</th> </tr> </thead> <tbody> <tr> <td>0</td> <td>None</td> </tr> <tr> <td>1</td> <td>Traverse</td> </tr> <tr> <td>2</td> <td>Proc PID</td> </tr> <tr> <td>3</td> <td>Reserved</td> </tr> <tr> <td>4</td> <td>Auto Sequence</td> </tr> </tbody> </table>	Setting	Function mode	0	None	1	Traverse	2	Proc PID	3	Reserved	4	Auto Sequence
Setting	Function mode												
0	None												
1	Traverse												
2	Proc PID												
3	Reserved												
4	Auto Sequence												
APP-08 Trv Amplit %	Sets the operation frequency for the scramble operation as a percentage of the inverter's frequency reference.												
APP-09 Trv Scramb %	Sets the scramble frequency (frequency jump volume at the beginning of a deceleration) for traverse operation as a percentage of the traverse operation frequency.												

Code	Description
APP-10 Trv Acc Time, APP-11 Trv Dec Time	Sets the acceleration and deceleration time for the traverse operation.
APP-12 Trv Offset Hi	Sets the high offset amount for the traverse operation as a percentage of the inverter's frequency reference. After setting one of the multi-function terminals to "28 (Trv Offset Hi)", the offset value is added to the traverse operation frequency when the terminal input is on.
APP-13 Trv Offset Lo	Sets the low offset amount for traverse operation as a percentage of the inverter's frequency reference. After setting one of the multi-function terminals to "27 (Trv Offset Lo)", the offset value is deducted from the traverse operation frequency when the terminal input is on.

8.36 Brake Control

Brake control is used to control the On/Off operation of the electronic brake load system. Check the inverter's control mode set at DRV-09 before configuring the brake control sequence as the operation sequence varies by the control mode.

Group	Code	Name	LCD Display	Parameter Setting		Setting Range	Unit
DRV	09	Control mode	Control Mode	0	V/F	-	-
				1	V/F PG		
				2	Slip Compen		
				3	Sensorless-1		
				4	Sensorless-2		
				5	Vector		
ADV	41	Brake release current	BR Rls Curr	50.0		0.0–180.0%	%
	42	Brake release delay time	BR Rls Dly	1.00		0–10.00	sec
	44	Brake release forward frequency	BR Rls Fwd Fr	1.00		0–400	Hz
	45	Brake release reverse frequency	BR Rls Rev Fr	1.00		0–400	Hz
	46	Brake engage delay time	BR Eng Dly	1.00		0–10	sec
	47	Brake engage frequency	BR Eng Fr	2.00		0–400	Hz
OUT	31–32	Multi-function relay1–2	Relay 1–2	35	BR Control:	-	-
	33	Multi-function output1 item	Q1 Define				

Brake Control Details

Code	Description
ADV-12 Dc-Start Time ADV-15 Dc Brake Time ADV-16 Dc Brake Level ADV-20 Acc Dwell Freq, ADV-21 Acc Dwell Time, ADV-22 Dec Dwell Freq, ADV-23 Dec Dwell Time ADV-42 BR Rls Dly ADV-44 BR Rls Fwd Fr ADV-45 BR Rls Rev Fr ADV-46 BR Eng Dly ADV-47 BR Eng Dly	<p>When the brake control is activated, DC braking (ADV-12) at inverter start and dwell operation (ADV-20–23) do not operate.</p> <p>Brake Operation Sequence in Control Modes Other than “Vector”</p> <p><Brake release sequence> During the motor stop state, if an operation command is entered, the inverter accelerates up to the brake release frequency (ADV-44–45) in a forward or reverse direction. After reaching the brake release frequency, if the motor current reaches the brake release current (BR Rls Curr), the output relay or multi-function output terminal for brake control sends a release signal. Once the signal has been sent, acceleration will begin after maintaining the frequency for the brake release delay time (ADV-42 BR Rls Dly).</p> <p><Brake engage sequence> If a stop command is sent during operation, the motor decelerates. Once the output frequency reaches the brake engage frequency (ADV-47 BR Eng Fr), the motor stops decelerating and sends out a brake engage signal to a preset output terminal. The frequency is maintained for the brake engage delay time (ADV-47 BR Eng Dly) and it becomes “0” afterwards. If the DC braking time (ADV-15) and DC braking resistance (ADV-16) are set, the inverter output is blocked after DC braking. For more details on DC braking, refer to 7.17.2 Stop after DC Braking on page 184.</p> <p>Brake Operation Sequence in “Vector” control Mode</p> <p><Brake release sequence> When an operational command is entered, the output relay or multi-function output terminal for brake control sends a brake release signal after the pre-excitation time is passed. Once the signal has been sent, acceleration will begin after the brake release delay time (ADV-42 BR Rls Dly) has passed.</p> <p><Brake engage sequence> If a stop command is sent during operation, the inverter decelerates to “0 Hz” and sends out a brake engage signal. Then, the output is cut off after the brake engage delay time (ADV-46 BR Eng Dly) has passed. The brake engage sequence does not operate in torque control mode.</p>

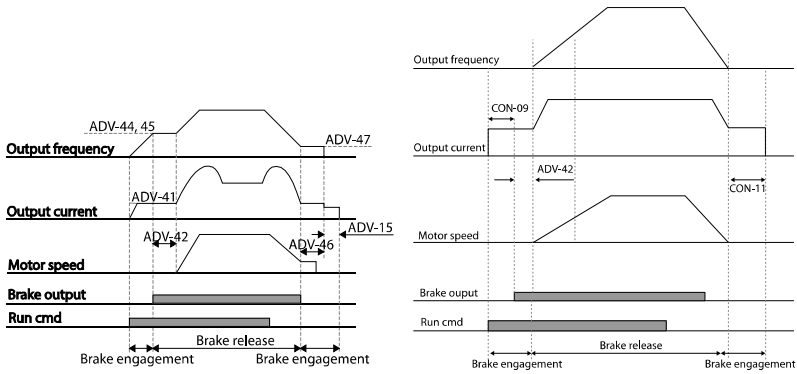

8.37 Multi-function Output On/Off Control

Group	Code	Name	LCD Display	Parameter Setting		Setting Range	Unit
ADV	66	Output contact On/Off control options	On/Off Ctrl Src	1	V1	0-4	-
	67	Output contact point On level	On-C Level	-	90.00	10-100	%
	68	Output contact point Off level	Off-C Level	-	10.00	0-Output contact on level	%
OUT	31-33	Multi-function relay, Multi-function output 1	Relay x or Q1	34	On/Off Control	-	-

Multi-function Output On/Off Control Details

Code	Description
ADV-66 On/Off Ctrl Src ADV-67 On-C Level ADV-68 Off-C Level	<p>If the analog input value exceeds the set value, the output relay or multi-function output terminal can be turned on or off. Select the analog input to use for On/Off control at ADV-66 and set the levels at which the output terminal is on and off at ADV-67 and 68 respectively.</p> <p>If the analog input value exceeds the value set at ADV-67, the output terminal is on. If the analog input is below the value set at ADV-68, the output terminal is off.</p>

8.38 MMC function

The MMC (Multiple Motor Control) function is used to control multiple motors of a pump system. The main motor connected with the inverter output is controlled by the PID controller. The auxiliary motors are connected with the supply power and turned on and off by the relay within the inverter.

The relay for controlling auxiliary motors uses Relay 1 and 2 in the standard I/O module embedded in the inverter and multi-function output terminal Q1. If the I/O expansion option module is connected to the inverter option slot, up to 3 relay outputs can be used.

Group	Code	Name	LCD Display	Parameter Setting		Setting Range	Unit
APP	01	Application mode	App Mode	3	MMC	-	-
APO	20	Aux motor rotation number	Aux Motor Run	-	0	0-4	-
	21	Starting aux motor selection	Starting Aux	-	1	1-4	-
	22	Auto operation time	Auto Op Time	-	0:00	xx:xx	Min
	23	1st aux motor starting frequency	Start Freq 1	-	49.99	0-60	Hz
	24	2nd aux motor starting frequency	Start Freq 2	-	49.99	0-60	Hz
	25	3rd aux motor starting frequency	Start Freq 3	-	49.99	0-60	Hz
	26	4th aux motor starting frequency	Start Freq 4	-	49.99	0-60	Hz
	27	1st aux motor stop frequency	Stop Freq 1	-	15.00	0-60	Hz
	28	2nd aux motor stop frequency	Stop Freq 2	-	15.00	0-60	Hz
	29	3rd aux motor stop frequency	Stop Freq 3	-	15.00	0-60	Hz
	30	3th aux motor stop frequency	Stop Freq 4	-	15.00	0-60	Hz
	31	Aux motor starting delay time	Aux Start DT	-	60.0	0-3600.0	Sec
	32	Aux motor stop delay time	Aux Stop DT	-	60.0	0-3600.0	Sec
APO	33	Aux motor number selection	Num of Aux	-	4	0-4	-
	34	Bypass selection	Regul Bypass	0	No	0-1	-
	35	Auto change mode	Auto Ch Mode	0	Aux	None/Aux/Main	-

Group	Code	Name	LCD Display	Parameter Setting		Setting Range	Unit
		selection					
	36	Auto change time	Auto Ch Time	-	72:00	0-99:00	Min
	38	Interlock selection	Interlock	0	No	0-1	-
	39	Interlock movement delay time	Interlock DT	-	5.0	0.1-360.0	Sec
	40	Aux motor rotation pressure difference	Actual Pr Diff	-	2	0-100%	%
	41	Main motor acceleration time when the number of pumps decreases	Aux Acc Time	-	2.0	0.0-600.0	Sec
	42	Main motor deceleration time when the number of pumps increases	Aux Dec Time	-	2.0	0.0-600.0	Sec
OUT	31-33	Multi-function relay, Multi-function output 1	Relay x or Q1	24	MMC	-	-
	34-36	Qx terminal configuration	Qx Define	24	MMC	-	-

8.38.1 Basic MMC Operation

Code	Description
APP-01 APP Mode	If "3 (MMC)" is selected for the applied function, the items related to the MMC function are displayed in the option module function group (APO) and the functions related to the PID controller are displayed in APP.
APO-20, 21, 33	If the number of auxiliary motors is set at APO-33 and there is more than one auxiliary motor, the auxiliary motor number for the first operation should be APO-21. For example, if there are three auxiliary motors and each of them is controlled by Relay 1 and 2 and the Q1 terminal, the auxiliary motors operate in the sequence of Relay 2, Q1, and then Relay 1 when "2" is input at APO-21. The auxiliary motors stop in the sequence of Relay 1, Q1, and Relay 2. At APO-20, the number of currently operating auxiliary motors can be monitored.
APO-23–26 Start Freq 1–4	<p>Sets the starting frequency for auxiliary motors. Since the main motor is operated by the PID controller, its operating frequency is increased by the load change and the operation for an auxiliary motor becomes necessary. The conditions of the inverter output terminal I (Relay or multi-function output [Qx]) that turns on for auxiliary motor operation is as follows. The auxiliary motor can operate when</p> <ul style="list-style-type: none"> • The speed of the main motor exceeds the starting frequency (APO-23–26) of the auxiliary motor. • The starting delay time (APO-13) of the auxiliary motor passes. • The difference between the reference and the feedback of the main motor PID controller becomes smaller than the pressure difference (APO-40) of the auxiliary motor motion.
APO-27–30 Stop Freq 1–4	<p>Sets the stop frequency for auxiliary motors. If the operating frequency for the main motor decreases below a certain frequency while the auxiliary motor is running, the auxiliary motor should be stopped. The condition of the auxiliary motor to be stopped is as follows. The auxiliary motor can be stopped when</p> <ul style="list-style-type: none"> • The speed of the main motor decreases below the stop frequency (APO-27–30) for the auxiliary motor. • The stop delay time (APO-32) for the auxiliary motor passes. • The difference between the reference and the feedback of the main motor PID controller becomes larger than the pressure difference (APO-40) of the auxiliary motor operation.
APO-41 Aux Acc Time, APO-42 Aux Dec Time	The main motor stops PID control and operates the normal acceleration and deceleration when the auxiliary motor runs or stops. When the auxiliary motor runs, the main motor decelerates to the decelerating frequency of the auxiliary motor for the decelerating time set at APO-42. Inversely, when the auxiliary motor stops, the main motor accelerates to the starting frequency for the accelerating time set at APO-41.

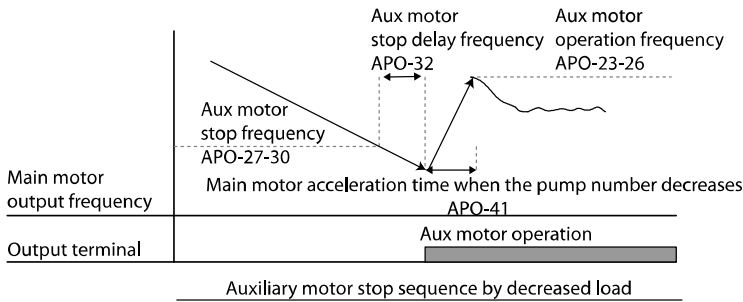
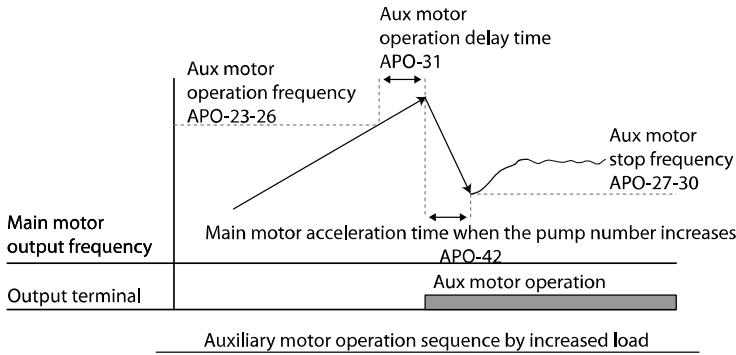

8.38.2 Auto Change Operation

The auto change function enables the inverter to automatically switch operations between main and auxiliary motors. Prolonged continuous operation of a motor reduces motor performance. The auto change function switches the motors automatically when certain conditions are met to avoid biased use of certain motors and protect them from deterioration.

Code	Description
APO-35 Auto Ch Mode	<p>Selects the motors to apply the auto change function.</p> <p>0: None The operation sequence of the auxiliary motor starts with the auxiliary motor selected at APO-21 (starting auxiliary motor selection) and the automatic change function is not active.</p>

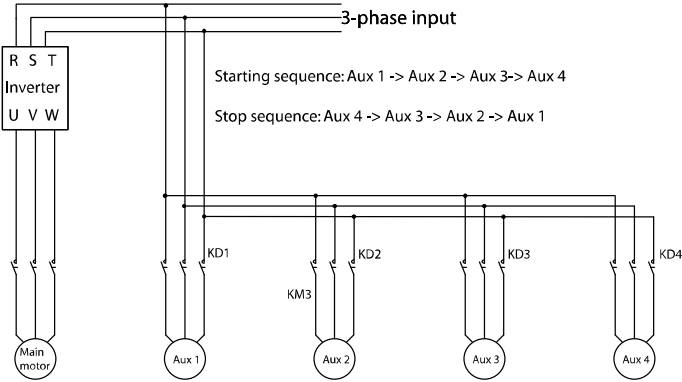
Code	Description
	<p>1: Aux</p> <p>The operation sequence of the auxiliary motor starts with the auxiliary motor selected in APO-21 (starting auxiliary motor selection). When the cumulative operating time for a main and auxiliary motor exceeds the auto change time (APO-36), the auto change condition is met. If the main motor is stopped by a stop command or the sleep operation mode after the auto change condition, the start sequence of the auxiliary motor selected at APO-21 is changed.</p> <p>For example, if there are four auxiliary motors operating and motor 4 is selected in APO-21, the start sequence of the auxiliary motor automatically changes to motor 1. Therefore, the previous start sequence of the auxiliary motor of 4, 1, 2, and 3 changes to 1, 2, 3, and 4, and if the auto change condition is met, the sequence is changed to 2, 3, 4, and 1.</p>  <p>2: Main</p> <p>Auto change is available without distinction between the main and auxiliary motors. The auto change condition is met if the cumulative operating time for the motor connected to the inverter output exceeds the auto change time (APO-36).</p> <p>If the inverter is stopped by a stop command or sleep operation mode, the operating sequence of the motor automatically changes. For example, if the starting auxiliary motor selection (APO-21) is set at "2", the inverter output is connected to motor 2. If there are four motors and the auxiliary motor operating condition is met, motors 3, 4, and 1 start operating one after another in sequence. If the inverter stops in the auto change condition, motor 3 is connected to the inverter output in the next restart and the auxiliary motors operate in the sequence of 4, 1, and 2.</p>

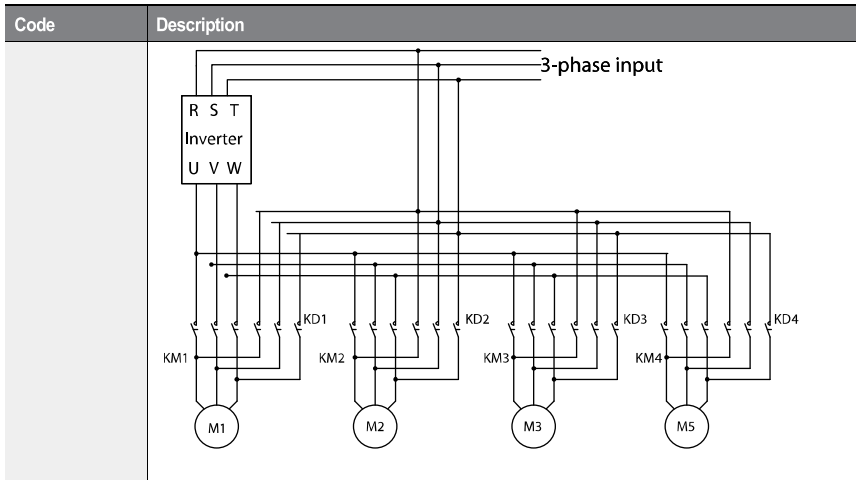

8.3.8.3 Interlock Operation

When there is motor trouble, the interlock feature is used to stop the affected motor and replace it with another that is not currently operating (i.e. in the off state). To activate the interlock feature, connect the cables to send abnormal motor signals to the inverter input terminal and configure the terminals as interlock 1–4 inputs. Then, the inverter decides the motor’s availability based on the signal inputs. The order in which the alternative motor is selected is decided based on the auto change mode selection options set at APO-35.

Code	Description
IN-65–75 Px Define	<p>The terminal to use as the interlock among IN 65–72 (up to 75 if there is an I/O expansion module) is selected and Interlock 1–4 are set depending on the motor sequence.</p> <p>If the auto change mode selection (APO-35) is set to “0 (None)” or “1 (Aux)” and if auxiliary motors 1, 2, and 3 are connected to inverter output terminals Relay 1, 2, and Q1 when a total of four motors including the main motor is operating, the interlock numbers 1, 2, and 3 correspond to the motor connected to Relay 1, 2, and Q1.</p> <p>However, if the auto change mode selection (APO-35) is set to “2 (Main)” and the main and auxiliary motors are connected to inverter output terminals Relay1, 2, Q1, and Q2 (I/O expansion module used) respectively, Interlock 1, 2, 3 and 4 correspond to the motors connected</p>

Code	Description
	to Relay 1, 2, Q1 and Q2.
APO-38 Interlock	<p>Select "1 (Yes)" to enable an interlock operation.</p> <p><u>1) If there are five motors and the auto change mode selection (APO-35) is set to "0 (None)" or "1 (Aux)", the operation is as follows:</u></p> <p>If signals are sent to the terminal block set at Interlock 3 with a fault at motor 3 when it is static, the auxiliary motors operate in the sequence of 1, 2, and 4 (when the starting auxiliary motor selection APO-21 is "1"). If the terminal block signals are released, the operation sequence is 1, 2, 3, and 4.</p> <p>If signals are sent to the terminal for Interlock 3, auxiliary motor 3 stops and auxiliary motor 4 operates. If the interlock signal is released, auxiliary motor 4 stops and auxiliary motor 3 operates again.</p> <p><u>2) If there are four motors and the auto change mode selection (APO-35) is set to "2 (Main)", the operation is as follows:</u></p> <p>If the starting auxiliary motor selection APO-21 is set to "1", motor 1 is operated by the inverter and the remaining motors (2, 3, and 4) are operated by the auxiliary motors and interlock signals are sent to the auxiliary motors, the operation sequence is the same as the procedure described in condition 1) above.</p> <p>However, if there is a problem with motor 1, which is connected to the inverter, the output is immediately blocked and motor 2 becomes connected to the inverter output and the operation sequence of the auxiliary motor is 3 and 4. If the interlock signal of motor 1 is released, the operation sequence of the auxiliary motor is 3, 4, and 1.</p>

8.38.4 Bypass Operation (Regular Bypass)

This function controls the motor speed based on the feedback amount instead of using the PID controller. Auxiliary motors may be controlled with this feature based on the feedback amount.

Code	Description
APP-34 Regular Bypass	<p>Select "1 (Yes)" to enable regular bypass.</p> <p>If there are four main motors and auxiliary motors (APP-33) in total, the operation is as follows. If the feedback input value is between 0–10 V and the operating frequency of the maximum input value (10 V) is 60 Hz, auxiliary motor 1 starts operation when the feedback amount is 2.5 V (15 Hz of main motor operating frequency).</p> <p>If the feedback amount reaches 5 V again, auxiliary motor 2 operates. At the maximum input of 10 V, all three auxiliary motors operate.</p> <p>Operation level of auxiliary motor $n = n * \frac{\text{Maximum feedback amount}}{\text{The number of auxiliary motor(APO - 33)}}$</p>

8.39 Press Regeneration Prevention (To evade control operation in the status of regeneration during press)

Press regeneration prevention is used during press operations to prevent braking during the regeneration process. If motor regeneration occurs during a press operation, the motor operation speed automatically goes up to avoid the regeneration zone.

Group	Code	Name	LCD Display	Parameter Setting	Setting Range	Unit	
ADV	73	Regeneration evasion mode	RegenAvd Mode	000-111	001	Bit	
	74	Regeneration evasion function for press selection	RegenAvd Sel	0	No	0-1	-
	75	Press regeneration prevention operation voltage level	RegenAvd Level	350	200 V class: 300-400	V	
				700	400 V class: 600-800		
	76	Press regeneration prevention compensation frequency limit	CompFreq Limit	1.00	0-10.00	Hz	
	77	Press regeneration prevention P-Gain	RegenAvd Pgain	50.0	0-100.0	%	
78	Press regeneration prevention I gain	RegenAvd Igain	500	20-30,000	ms		

Press Regeneration Prevention Details

Code	Description
ADV-73 RegenAvd Mode	Set the motor operation mode to decide when the regeneration evasion function is activated.
ADV-74 RegenAvd Sel (select regeneration evasion function for press)	Frequent regeneration voltage from a press load during a constant speed motor operation may put excessive stress on the braking unit, which may damage or shorten brake life. To prevent this, select ADV-74 (RegenAvd Sel) to control DC link voltage and disable the braking unit operation.
ADV-75 RegenAvd Level (set regeneration evasion level for press)	Set brake operation prevention level voltage when the DC link voltage goes up due to regeneration.

Code	Description
ADV-76 CompFreq Limit (limit regeneration evasion compensation frequency for press)	Set an alternative frequency width that can replace the actual operation frequency during regeneration prevention.
ADV-77 RegenAvd P gain	Set a P gain for regeneration evasion compensation function. To avoid the regeneration zone, set P-Gain in the DC link voltage suppress PI controller.
ADV-78 RegenAvd I gain	Set an I gain for regeneration evasion compensation function. To avoid the regeneration zone, set I gain in the DC link voltage suppress PI controller.

ⓘ Caution

Press regeneration prevention does not operate during acceleration or deceleration; it only operates during constant speed motor operation. When regeneration prevention is activated, the output frequency may change within the range set at ADV-76 (CompFreq Limit).

8.40 Anti-Hunting Regulator

Group	Code	Name	LCD Display	Parameter Setting		Setting Range	Unit
CON	90	Function selection for preventing current hunting	New AHR Sel.	1	Yes	-	-
	91	Gain from current hunting prevention	AHR P-Gain	1000		0–32767	-

This function is used to prevent the hunting of a V/F controlled fan or motor caused by current distortion or oscillation due to mechanical resonance or other reasons. You can set the hunting prevention function (CON-90) to prevent current hunting.

CON-91 AHR P-Gain: Increasing AHR proportional gain improves the responsiveness of the anti-hunting regulation. However, current oscillation may result if AHR proportional gain is set too high.

8.41 Fire Mode

This function is used to allow the inverter to ignore minor faults during emergency situations, such as fire, and provides continuous operation to protect other systems, such as ventilation fans. When fire mode is activated, the inverter operates continuously based on the set frequency and direction.

Group	Code	Name	LCD Display	Parameter Setting		Setting range	Unit
ADV	80	Fire mode selection	Fire Mode Sel	0	None	0–2	-
				1	Fire Mode		-
				2	Fire Test		-
	81	Fire mode frequency	Fire Mode Freq	60.00			Hz
ADV	82	Fire mode operating direction	Fire Mode Dir	0	Forward	0–1	-
				1	Reverse		-
	83	Fire mode counter	Fire Mode Cnt	0		-	-
IN	65–75	Px terminal configuration	Px Define	51		-	-
OUT	31–33	Relay1,2 and Q1	Relay1,2 / Q1	37		-	-

Fire Mode Details

Code	Description
ADV-80 Fire Mode Sel	When you select function 1-Fire Mode, ADV-81–83 is displayed. In the above settings, if "51 (Fire Mode)" in IN-65–75 is on, fire mode operates. During the fire mode operation status, a "fire mode" warning occurs. During fire mode operation, the inverter's frequency and operation direction is performed in the value set for fire mode with the previously set control mode.
ADV-81 Fire Mode Freq	Set the operation frequency for fire mode.
ADV-82 Fire Mode Dir	Set the run direction for fire mode operation.
ADV-80 Fire Mode Sel	If the mode is set to "2-Fire Test", related items for the fire function (ADV-81–83) are displayed. In the above settings, if "51 (Fire Mode)" in IN-65–75 is on, fire mode operates. The basic operation is the same as fire mode. However,

Code	Description
	ADV-83 is not counted in fire test mode. Also, all fault trips occur without ignoring them.

If a fault occurs during fire mode operation, the fault trip is ignored and the inverter continuously operates. However, if a critical fault occurs, the inverter performs the trip operation or auto restart operation. The auto restart is performed after PRT-10 Retry Delay is set.

If the inverter performs the fire mode operation when the inverter is in normal status after the auto restart, the inverter will operate via the speed search.

Fire mode cannot be set while in torque mode. Therefore, fire mode can only be set when the inverter is in speed or operation mode.

In fire mode, the operation for fault trips is listed in the following table.

Operation in the event of fault trips	Fault trips
Fault trips that are ignored	Low Voltage , Over Load, Under Load, Inverter OLT, E-Thermal, Out Phase Open, In Phase Open, Over Speed, Speed Dev Trip, NTC Open, Over Heat, Fuse Open, Thermal Trip, Fan Trip, BX, Lost Command, Lost Keypad, Low Voltage2, etc.
Auto restart after fault trips	Ground Trip, Over Current1, Over Voltage
Trip operation	HW-Diag, Over Current2, Safety Opt Err

ⓘ Caution

Fire mode operation voids the product warranty. To test fire mode not to increase the fire mode operation count at ADV-83, set ADV-80 to "2-Fire Test" and operate the inverter.

If the multi-function terminal input set to "51 (Fire Mode)" is on when ADV-83 is set to "1 (Fire Mode)", the count value set at ADV-83 is increased by 1.

8.42 Dynamic Braking (DB) Resistor Operation Reference Voltage

Depending on the capacity, the iS7 series is divided into models with a braking resistor circuit integrated inside the inverter, and models that require an external braking unit to be installed. The inverters rated between 0.75–22 kW have the built-in braking model (except for the braking resistor), and the inverters rated above 30 kW require an external braking unit. Therefore, the reference voltage setting function for the braking resistor is necessary for inverters rated below 22 kW.

Group	Code	Name	LCD Display	Parameter Setting	Setting Range	Unit
ADV	79	DB unit operating voltage	DB Turn On Lev	390 V	200 V Type: 350–400 V	V
				780 V	400 V Type: 600–800 V	

ADV-79 DB Turn On Lev: This is the operation reference voltage for the braking resistor. The braking resistor operates when the DC link voltage exceeds the reference value.

The initial value for 200 V-type inverters is 390 V, and the initial value for 400 V-type inverters is 780 V.

For 200 V-type inverters, the reference voltage that stops the braking resistor is 10 V lower than the operating voltage set at ADV-79. For 400 V-type inverters, the braking resistor stops if the voltage is 20 V lower than the operating voltage set at ADV-79.

⚠ Caution

If the set value for ADV-79 is lower than the DC link voltage when the inverter is in normal operation, the DB resistor may overheat due to continuous DB resistor operation. Conversely, if the set value at ADV-79 is much higher than the DC link voltage range, an overvoltage trip may occur because the DB resistor does not operate when it is needed.

Example) If the input voltage is 440 V and the value at ADV-79 is set to 600 V, the DB resistor operates when the inverter is on because the DC link voltage is 622 V. Since the voltage level that stops the DB resistor is 590 V, the DB resistor may overheat due to continuous DB resistor operation.

8.43 kW/HP Unit Selection

Select the units between kW and HP for the capacity of the inverter and motor.

Group	Code	Name	LCD Display	Parameter Setting	Setting Range	Unit
DRV	30	kW/HP unit selection	KW/HP Select	0	0-1	-
				1		

8.44 Output Voltage Drop Prevention

This function is used to prevent voltage drop in the inverter output by decreasing the current output, thereby taking advantage of the expanded command zone of the output voltage, if the input voltage drops or overload conditions arise.

Group	Code	Name	LCD Display	Parameter Setting		Setting Range	Initial
ADV	87	OVM Mode selection	OVM Mode Sel	0	No	0-1	0:No
				1	Yes		

This function is used to prevent voltage drop in the inverter output by decreasing the current output, thereby taking advantage of the expanded command zone of the output voltage, if the input voltage drops or overload conditions arise. Set ADV-87 (OVM Mode Sel) to "0 (No)" to limit the voltage output command zone for linear voltage output. Set ADV-87 (OVM Mode Sel) to "1 (Yes)" to expand the voltage output zone command zone and ensure stable voltage output is made throughout the overmodulated zone.

Caution



- **When you enable the OVM Mode, the output wave may be distorted because it will not be maintained in a linear form.**
- **Also, a higher voltage than the motor's rated voltage may be output to the motor if the input voltage is higher than the motor's rated voltage.**
- **Although the current may appear to be rapidly oscillating during high-speed operation, the actual change in the output current is not severe.**
- **The output voltage will be compensated for to stay below the rated voltage of the motor according to the parameter setting.**
- **The OVM Mode will not be activated if the input voltage is higher than the output voltage.**

9 Using Monitor Functions

9.1 Monitoring the Operating Status via the Keypad

You can monitor the operating status using the keypad of the inverter. You can select the desired items to monitor in Config mode (CNF), view three items at a time in Monitor mode, and select an item on the status display.

9.1.1 Selecting Monitor Mode Display

Mode	Group	Code	LCD Display	Parameter Setting		Unit
CNF	-	21	Monitor Line-1	0	Frequency	Hz
	-	22	Monitor Line-2	2	Output Current	A
	-	23	Monitor Line-3	3	Output Voltage	V
		24	Mon Mode Init	0	No	-

Monitor Mode Display Selection Details

Code	Description		
CNF-21-23 Monitor Line-x	Select the items to monitor in Monitor mode. Monitor mode is displayed when the inverter is powered on. Also, all three items in Monitor Line-1-3 can be displayed simultaneously. Select an item for the line to display. If "Yes" is set at CNF-24 (Mon Mode Init), CNF-21-23 will be initialized.		
	Setting	Function	
	0	Frequency	Displays the set frequency while stopped. During operation, it displays the actual output frequency (Hz).
	1	Speed	Displays the set speed (rpm) while stopped. During operation, it displays the actual operating speed (rpm).
	2	Output Current	Displays the output current.
	3	Output Voltage	Displays the output voltage.
	4	Output Power	Displays the output power.
	5	WHour Counter	Displays the inverter's power consumption.
	6	DCLink Voltage	Displays the inverter's DC link voltage.
	7	DI Status	Displays the input terminal status of the terminal block. Starting from the right, it displays P1-P8.
8	DO Status	Displays the output terminal status of the terminal block.	

Code	Description	
		Starting from the right, it displays Relay1, Relay2, and Q1.
9	V1 Monitor[V]	Displays the input voltage value at terminal V1 (V).
10	V1 Monitor[%]	Displays the input voltage terminal V1 value as a percentage. If -10V, 0V, and +10V is measured, -100%, 0%, and 100% will be displayed.
11	I1 Monitor[mA]	Displays the magnitude of the current being input to the I1 terminal of the inverter terminal block.
12	I1 Monitor[%]	Displays the above current as a percent. If the input current is 0–20[mA], it is shown as 0–100%.
13	V2 Monitor[V]	Displays the voltage input of the I/O expansion module's V2 terminal when using the I/O expansion module.
14	V2 Monitor[%]	Displays the V2 input voltage as a percent.
15	I2 Monitor[mA]	Displays the current input for the I/O expansion module's I2 terminal when using the I/O expansion module.
16	I2 Monitor[%]	Displays the I2 input current terminal value as a percentage.
17	PID Output	Displays the PID controller's output.
18	PID Ref Value	Displays the PID controller's reference value.
19	PID Fdb Value	Displays the PID controller's feedback volume.
20	Torque	Displays the torque reference value if torque reference command mode (DRV-08) is set to a value other than "Keypad" (0 or 1).
21	Torque Limit	Displays the torque limit value if the torque limit setting method (CON-53) is set to a value other than "Keypad" (0 or 1).
22	Trq Bias Ref	Displays the torque bias if the torque bias setting method (CON-58) is set to a value other than "Keypad" (0 or 1).
23	Spd Limit	Displays the speed limit setting If the speed limiting (CON-62) in Torque Control mode is set to a value other than "Keypad" (0 or 1).
24	Load Speed	Displays the load speed in the desired scale and unit. Displays the load speed as values which are applied in the units of rpm or mpm set in ADV-63 (Load Spd Unit), ADV-61 (Load Spd Gain), and ADV-62 (Load Spd Scale).
25	Temperature	Displays the inverter's internal temperature.

9.1.2 Displaying Output Power

Mode	Group	Code	LCD Display	Parameter Setting		Unit
PAR	BAS	18	Trim Power %	-	100.0	%

When CNF-21–23 (Monitor Line-x Select) is set to “4 (Output Power)”, increase the set value at BAS-18 (Trim Power) appropriately if the output power displayed on the keypad is lower than expected.

If the output power displayed on the keypad is higher than expected, decrease this set value accordingly. The output power display is calculated using voltage and current. However, an output power error may occur when the power factor is low.

Note

WHour Counter (Inverter power consumption)

Values are calculated using voltage and current. Electric power is calculated every second and the results are accumulated.

Power consumption is displayed as follows:

- Less than 1,000 kW: Units are in kW, displayed in a 999.9 kW format.
- 1–99 MW: Units are in MW, displayed in a 99.99 MWh format.
- 100–999 MW: Units are in MW, displayed in a 999.9 MWh format.
- More than 1,000 MW: Units are in MW, displayed in 9,999 MWh format and can be displayed up to 65,535 MW. (Values exceeding 65,535 MW will reset the value to 0 and units will return to kW. It will be displayed in a 999.9 kW format).
- If the WH CNF-62 (Count Reset) is set to “YES,” you can clear the electricity consumption.

9.1.3 Selecting Load Speed Display

Mode	Group	Code	LCD Display	Parameter Setting		Unit
PAR	ADV	61	Load Spd Gain	-	100.0	%
		62	Load Spd Scale	0	X 1	-
		63	Load Spd Unit	0	rpm	-

Load Speed Display Details

Set CNF-21–23 (Monitor Line-x Select) to “24 (Load Speed)”, and adjust the following codes to display load speed.

Code	Description
ADV-61 Load Spd Gain	Sets the gear ratio in a percentage for speed conversion. When the ratio is set, the actual number of rotations of the other axis or gear system that is connected to the motor is displayed accordingly. For example, set ADV-61 (Load Spd Gain) to 30.0%, if the flux value is 300 [mpm] at 1000 [rpm].
ADV-62 Load Spd Scale	Selects to what decimal place to display at “24 (Load Speed)” among the monitor items (x1-x0.0001). If you want to display the value to one decimal place, set ADV-63 (Load Spd Scale) to X 0.1.
ADV-63 Load Spd Unit	Selects the unit of “24 (Load Speed)” from the monitor items. Also, select either RPM (Revolutions Per Minute) or MPM (Meters Per Minute).

9.1.4 Selecting Hz/Rpm Display

You can convert all the parameters with a Hz unit into RPM or vice versa. The pole number (BAS-11) must be entered for the conversion.

Mode	Group	Code	LCD Display	Parameter Setting		Unit
PAR	DRV	21	Hz/Rpm Sel	0	Hz	-
	BAS	11	Pole Number	-	4	-

Warning

If you change the default set value at DRV-21 (Hz/RPM Sel) from “Hz” to “RPM”, all parameters except the ones set for the monitor mode will be changed to RPM. To change the speed unit from frequency to speed in Monitor mode, change the parameter value at CNF-21.

9.1.5 Selecting Status Display

Mode	Code	LCD Display	Parameter Setting		Unit
CNF	20	AnyTime Para	0	Frequency	-

Status Display Selection Details

Code	Description			
CNF-20 AnyTime Para	Select the variables to be displayed at the top of Keypad display (LCD display).			
	Setting	Function	Setting	Function
	0	Frequency	13	V2 Monitor[V]
	1	Speed	14	V2 Monitor[%]
	2	Output Current	15	I2 Monitor[mA]
	3	Output Voltage	16	I2 Monitor[%]
	4	Output Power	17	PID Output
	5	WHour Counter	18	PID Ref Value
	6	DCLink Voltage	19	PID Fdb Value
	7	-	20	Torque
	8	-	21	Torque Limit
	9	V1 Monitor[V]	22	Trq Bias Ref
	10	V1 Monitor[%]	23	Speed Limit
	11	I1 Monitor[mA]	24	Load Speed
12	I1 Monitor[%]			

9.1.6 Monitoring Output Frequency

Select DRV-25 to monitor output frequency. Output frequency is displayed in 0.01[Hz] increments. The output frequency is displayed as 0.00[Hz] when the inverter is not operating.

Group	Code	LCD Display	Parameter Setting		Unit
DRV	25	Output Freq	-	0.00	Hz

9.2 Monitoring Fault Status Using Keypad

Trip mode displays the fault status when a fault trip occurs during inverter operation. You can monitor the fault types, operating frequency, and output current at the time of fault trip. Up to the last 5 fault trips can be saved.

9.2.1 Monitoring Current Fault Status

When a fault trip occurs, the fault type is displayed on the keypad's display.

TRP Current	
Over Voltage (02)	
01 Output Freq	35.10 Hz
02 Output Current	15.5 A

For more details on types and descriptions of fault trips, refer to [12.2 Warning Messages](#) on page 373. The following operating status can be monitored and recorded.

Displayed Information	Description
1 Output Freq	Displays the operating frequency at the time of the fault trip.
2 Output Current	Displays the output current at the time of the fault trip.
3 Inverter State	Displays acceleration, deceleration, constant speed operation, and stop state.
4 DCLink Voltage	Displays the inverter's DC power voltage.
5 Temperature	Displays the inverter's temperature.
6 Input State	Displays the input terminal's status.
7 Output State	Displays the output terminal's status.
8 Trip On Time	Displays the time from the power ON to the fault trip.
9 Trip Run Time	Displays the time from Run to the fault trip.

If you press the [STOP/RESET] key on the keypad or input the reset terminal of the terminal block to release the fault trip, the information for the currently displayed fault trip is saved as part of the fault trip history. In this case, what was saved in the Fault Trip History 1 (Last-1) is moved to the Failure History 2 (Last-2).

The number next to the fault trip name represents the number of simultaneously occurring faults. If more than one fault occurred, you can press the [PROG/ENT] key to view the other faults.

9.2.2 Monitoring Fault Trip History

The types of up to five previous fault trips can be saved and monitored. The lower the number of Last X is, the more recent the fault it represents. If more than 5 faults occur, those occurring before the last 5 are automatically deleted.

The items displayed in the fault trip history are listed in the following table.

Displayed Information		Description
0	Trip Names(1)	Displays the fault types.
1	Output Freq	The operating frequency at the time of the fault occurrence.
2	Output Current	The output current at the time of the fault occurrence.
3	Inverter State	Displays acceleration, deceleration, constant speed operation, and stop state.
4	DCLink Voltage	Displays the inverter's DC power voltage.
5	Temperature	Displays the inverter's temperature.
6	Input State	Displays the input terminal's status.
7	Output State	Displays the output terminal's status.
8	Trip On Time	Displays the time from the power ON to the fault occurrence.
9	Trip Run Time	Displays the time from Run to the fault occurrence.
10	Trip Delete ?	Displays whether the currently saved fault trip history is to be deleted.

There are two ways to delete the fault trip history.

At each fault trip, To delete the individual fault trip, select "Yes" at TRP-10 (Trip Delete?). Also, to delete the entire fault trip history, select "Yes" at CNF-24 (Erase All Trip).

9.3 Analog output

9.3.1 Voltage Output (0–10 V)

Select the items to be output from AO1 (Analog Output 1) terminal of the inverter terminal block and adjust the output sizes.

Group	Code	LCD Display	Parameter Setting		Unit
OUT	01	AO1 Mode	0	Frequency	-
	02	AO1 Gain	-	100.0	%
	03	AO1 Bias	-	0.0	%
	04	AO1 Filter	-	5	ms
	05	AO1 Const %	-	0.0	%
	06	AO1 Monitor	-	0.0	%

Voltage Output Setting Details

Code	Description																			
OUT-01 AO1 Mode	Select the output types.																			
		<table border="1"> <thead> <tr> <th>Setting</th> <th>Description</th> </tr> </thead> <tbody> <tr> <td>0</td> <td>Frequency</td> </tr> <tr> <td>1</td> <td>Output Current</td> </tr> <tr> <td>2</td> <td>Output Voltage</td> </tr> <tr> <td>3</td> <td>DC Link Volt</td> </tr> <tr> <td>4</td> <td>Torque</td> </tr> <tr> <td>5</td> <td>Output Power</td> </tr> <tr> <td>6</td> <td>Idse</td> </tr> <tr> <td>7</td> <td>Iqse</td> </tr> </tbody> </table>	Setting	Description	0	Frequency	1	Output Current	2	Output Voltage	3	DC Link Volt	4	Torque	5	Output Power	6	Idse	7	Iqse
	Setting	Description																		
	0	Frequency																		
	1	Output Current																		
	2	Output Voltage																		
	3	DC Link Volt																		
	4	Torque																		
	5	Output Power																		
6	Idse																			
7	Iqse																			
0	Frequency	Outputs an operation frequency as the standard. A 10 V output is supplied based on the frequency set at DRV-20 (Max Freq).																		
1	Output Current	A 10 V output is supplied from 200% of the inverter-rated current (based on CT: Constant Torque).																		
2	Output Voltage	Sets the outputs based on the inverter output voltage. A 10 V output is supplied from the voltage set at BAS-15 (Rated V). If 0 V is set at BAS-15, 200 V/400 V models output 10 V based on the actual input voltage (220 V and 440 V respectively).																		
3	DC Link Volt	Outputs the inverter DC link voltage as the standard. Outputs 10 V when the DC link voltage is 410 VDC for 200 V models, and 820 VDC for 400 V models.																		
4	Torque	Outputs the generated torque as the standard. Outputs 10 V at 250% of the motor-rated torque.																		
5	Output Power	Monitors the output wattage. 200% of the rated output is the maximum display voltage (10 V).																		
6	Idse	Outputs the maximum voltage at 200% of the no load current.																		
7	Iqse	Outputs the maximum voltage at 250% of the rated torque current. Rated torque current = $\sqrt{\text{rated current}^2 - \text{Non-load current}^2}$																		

Using Monitor Functions

Code	Description												
8	Target Freq	Outputs the set frequency as the standard. Outputs 10 V at the maximum frequency (DRV-20).											
9	Ramp Freq	Outputs frequency calculated with Acc/Dec function as a standard. This may vary depending on the actual output frequency. Outputs 10 V.											
10	Speed Fdb	Displays the speed information of the input into the encoder extension module. It produces 10 V at the maximum frequency (DRV-20).											
11	Speed Dev	Outputs the difference between the speed reference (command) and the motor's rotation speed that inputs into the encoder extension module. It outputs 10 V at twice the rated slip frequency. It is valid only in Vector Control mode.											
12	PID Ref Value	Outputs command value of a PID controller as the standard. Outputs approximately 6.6 V at 100%.											
13	PID Fdb Value	Outputs feedback volume of a PID controller as the standard. Outputs approximately 6.6 V at 100%.											
14	PID Output	Outputs the output value of a PID controller as the standard. Outputs approximately 10 V at 100%.											
15	Constant	Outputs the OUT-05 (AO1 Const %) value as a standard.											
OUT-02 AO1 Gain, OUT-03 AO1 Bias	<p>Adjusts output value and offset. If frequency is selected as an output item, it will operate as shown below.</p> $AO1 = \frac{Frequency}{MaxFreq} \times AO1Gain + AO1Bias$ <p>The graph below illustrates how the analog voltage output (AO1) changes depending on OUT-02 (AO1 Gain) and OUT-3 (AO1 Bias) values. The Y-axis is analog output voltage (0–10 V), and the X-axis is a % value of the output item.</p> <p>Example, if the maximum frequency set at DRV-20 (Max Freq) is 60 Hz and the present output frequency is 30 Hz, then the x-axis value on the next graph is 50%.</p>												
	<table border="1"> <thead> <tr> <th colspan="2"></th> <th colspan="2">OUT-02 AO1 Gain</th> </tr> <tr> <th colspan="2"></th> <th>100.0% (Factory Default)</th> <th>80.0%</th> </tr> </thead> <tbody> <tr> <td>OUT-03 AO1 Bias</td> <td>0.0% (Factory Default)</td> <td> </td> <td> </td> </tr> </tbody> </table>			OUT-02 AO1 Gain				100.0% (Factory Default)	80.0%	OUT-03 AO1 Bias	0.0% (Factory Default)		
		OUT-02 AO1 Gain											
		100.0% (Factory Default)	80.0%										
OUT-03 AO1 Bias	0.0% (Factory Default)												

Code	Description
	<div style="display: flex; align-items: center;"> <div style="border: 1px solid black; padding: 5px; margin-right: 10px;">20.0%</div> </div>
OUT-04 AO1 Filter	Sets the filter time constant of the analog output.
OUT-04 AO1 Const %	Sets the analog output items to Constant (AO1 Mode: 15), and then the analog voltage is output at the value of the parameters set.
OUT-06 AO1 Monitor	Monitors the analog output value, which is represented as a percentage based on the 10 V maximum output voltage.

9.3.2 Current Output (4–20 mA)

Select the items to be output from AO2 (Analog Output 2) terminal of the inverter terminal block and adjust the output sizes.

Group	Code	LCD Display	Parameter Setting		Unit
OUT	07	AO2 Mode	0	Frequency	-
	08	AO2 Gain	-	80.0	%
	09	AO2 Bias	-	20.0	%
	10	AO2 Filter	-	5	ms
	11	AO2 Const %	-	0.0	%
	12	AO2 Monitor	-	0.0	%

Current Output Setting Details

Code	Description	
OUT-07 AO2 Mode	Select the output types.	
	Setting	Description
	0	Frequency
1	Output Current	A 10 V output is supplied from 200% of the inverter-rated current (based on CT: Constant Torque).

Using Monitor Functions

Code	Description					
	2	Output Voltage Sets the outputs based on the inverter output voltage. A 10 V output is supplied from the voltage set at BAS-15 (Rated V). If 0 V is set at BAS-15, 200 V/400 V models output 10 V based on the actual input voltage (220 V and 440 V respectively).				
	3	DC Link Volt Outputs the inverter DC link voltage as the standard. Outputs 10 V when the DC link voltage is 410 VDC for 200 V models, and 820 VDC for 400 V models.				
	4	Torque Outputs the generated torque as the standard. Outputs 10 V at 250% of the motor-rated torque.				
	5	Output Power Monitors the output wattage. 200% of the rated output is the maximum display voltage (10 V).				
	6	Idse Outputs the maximum voltage at 200% of the no load current.				
	7	Iqse Outputs the maximum voltage at 250% of the rated torque current. $\text{Rated torque current} = \sqrt{\text{rated current}^2 - \text{Non-load current}^2}$				
	8	Target Freq Outputs the set frequency as the standard. Outputs 10 V at the maximum frequency (DRV-20).				
	9	Ramp Freq Outputs frequency calculated with Acc/Dec function as a standard. This may vary depending on the actual output frequency. Outputs 10 V.				
	10	Speed Fdb Displays the speed information of the input into the encoder extension module. It produces 10 V at the maximum frequency (DRV-20).				
	11	Speed Dev Outputs the difference between the speed reference (command) and the motor's rotation speed that inputs into the encoder extension module. It outputs 10 V at twice the rated slip frequency. It is valid only in Vector Control mode.				
	12	PID Ref Value Outputs command value of a PID controller as the standard. Outputs approximately 6.6 V at 100%.				
	13	PID Fdb Value Outputs feedback volume of a PID controller as the standard. Outputs approximately 6.6 V at 100%.				
	14	PID Output Outputs the output value of a PID controller as the standard. Outputs approximately 10 V at 100%.				
	15	Constant Outputs the OUT-05 (AO1 Const %) value as a standard.				
OUT-08 AO2 Gain, OUT-09 AO2 Bias	<p>Adjusts output value and offset. If frequency is selected as an output item, it will operate as shown below.</p> $AO2 = \frac{\text{Frequency}}{\text{MaxFreq}} \times AO2\text{Gain} + AO2\text{Bias}$ <p>The graph below illustrates how the analog current output (AO2) changes depending on OUT-02 (AO2 Gain) and OUT-3 (AO2 Bias) values. The Y-axis is the analog output current (0–20 mA), and the X-axis is a percentage of the output. Example, if the maximum frequency set at DRV-20 (Max Freq) is 60 Hz and the present output frequency is 30 Hz, then the x-axis value on the next graph is 50%.</p> <table border="1" style="margin-left: auto; margin-right: auto;"> <thead> <tr> <th colspan="2">OUT- 08 AO2 Gain</th> </tr> </thead> <tbody> <tr> <td>100.0%</td> <td>80.0% (Factory Default)</td> </tr> </tbody> </table>		OUT- 08 AO2 Gain		100.0%	80.0% (Factory Default)
OUT- 08 AO2 Gain						
100.0%	80.0% (Factory Default)					

Code	Description		
	OUT-09 AO2 Bias	0.0%	<p>A graph with Y-axis from 0mA to 20mA and X-axis from 0% to 100%. A straight line starts at (0, 0) and ends at (100, 20). Dashed lines indicate points at 50% (10mA) and 80% (16mA).</p>
		20.0% (factory Default)	<p>A graph with Y-axis from 0mA to 20mA and X-axis from 0% to 100%. A straight line starts at (0, 4) and ends at (100, 20). Dashed lines indicate points at 50% (14mA) and 80% (16mA).</p>
		0.0%	<p>A graph with Y-axis from 0mA to 16mA and X-axis from 0% to 100%. A straight line starts at (0, 0) and ends at (100, 16). Dashed lines indicate points at 50% (8mA) and 80% (12.8mA).</p>
		20.0% (factory Default)	<p>A graph with Y-axis from 0mA to 20mA and X-axis from 0% to 100%. A straight line starts at (0, 4) and ends at (100, 20). Dashed lines indicate points at 50% (16.8mA) and 80% (12mA).</p>
OUT-10 AO2 Filter	Sets the filter time constant of the analog output.		
OUT-11 AO2 Const %	Sets the analog output items to Constant (AO2 Mode: 15), and then the analog current is output at the value of the parameters set.		
OUT-12 AO2 Monitor	Monitors the analog output value, which is represented as a percentage based on the 20 mA maximum output voltage.		

Note

When 4–20 mA is used as the output, tune OUT-08 AO2 Gain and OUT-09 AO2 Bias as follows.

- 1 Set OUT-07 AO2 Mode to Constant and OUT11 AO2 Const % to 0.0%.
- 2 After setting OUT-09 AO2 Bias to 20.0%, ensure that that the current is 4 mA. If the current is lower than 4 mA, gradually increase OUT-09 AO2 Bias until it measures 4 mA. If the current is higher than 4 mA, gradually decrease OUT-09 AO2 Bias until it measures 4 mA.
- 3 Set OUT11 AO2 Const % to 100.0%. After setting OUT-08 AO2 Gain to 80.0%, ensure that the current is 20 mA. If the current is lower than 20 mA, gradually increase OUT-08 AO2 Gain until it measures 20 mA. If the current is higher than 20 mA, gradually decrease OUT-08 AO2 Gain until it measures 20 mA.
- 4 When 0–20 mA is used as the output, set OUT-08 AO2 Gain to 100% and OUT-09 AO2 Bias to 0.0%.
- 5 The functions for each code are the same as the item of 0–10 V output. And, the output range is 0–20 mA.

9.3.3 Voltage Output (-10→+10V) Using an I/O Expansion Module

If the optional I/O expansion module is installed, the operating status can be monitored using the bipolar voltage output of the I/O expansion module.

Group	Code	LCD Display	Parameter Setting		Unit
OUT	14	AO3 Mode	0	Frequency	-
	15	AO3 Gain	-	100.0	%
	16	AO3 Bias	-	0.0	%
	17	AO3 Filter	-	5	Msec
	18	AO3 Const %	-	0.0	%
	19	AO3 Monitor	-	0.0	%

Voltage Output (-10→+10 V) Details

Code	Description															
OUT-14 AO3 Mode	The output mode can be set identically to when the AO1 voltage output is used. However, because bipolar voltage output is possible for AO3, unipolar (0→+10V) or bipolar (-10→+10V) voltage can be produced according to the type of the output variable. Examples of bipolar output voltages are as follows.															
	<table border="1"> <thead> <tr> <th>Output Direction</th> <th colspan="3">Related Functions</th> </tr> </thead> <tbody> <tr> <td rowspan="2">Forward(+) /Reverse(-)</td> <td>0: Frequency</td> <td>9: Ramp Freq</td> <td>10: Speed Fdb</td> </tr> <tr> <td>12: PID Ref Value</td> <td>13: PID Fdb Value</td> <td>14: PID Output</td> </tr> <tr> <td>Reverse(-) /Regenerative(-)</td> <td>4: Torque</td> <td>7: Iqss</td> <td>-</td> </tr> </tbody> </table>	Output Direction	Related Functions			Forward(+) /Reverse(-)	0: Frequency	9: Ramp Freq	10: Speed Fdb	12: PID Ref Value	13: PID Fdb Value	14: PID Output	Reverse(-) /Regenerative(-)	4: Torque	7: Iqss	-
	Output Direction	Related Functions														
	Forward(+) /Reverse(-)	0: Frequency	9: Ramp Freq	10: Speed Fdb												
12: PID Ref Value		13: PID Fdb Value	14: PID Output													
Reverse(-) /Regenerative(-)	4: Torque	7: Iqss	-													
OUT-15 AO3 Gain, OUT-16 AO3 Bias	The graph below illustrates how the analog voltage output (AO3) changes depending on the OUT-15 (AO3 Gain) and OUT-16 (AO3 Bias) values. The Y-axis is analog output voltage (-10→+10V), and the X-axis is a percentage of the output. For example, if the maximum frequency set at DRV-20 (Max Freq) is 60 Hz and the present output frequency is 30 Hz, then the x-axis value on the next graph is 50%.															
	<table border="1"> <thead> <tr> <th colspan="2">OUT-08 AO3 Gain</th> </tr> </thead> <tbody> <tr> <td>100.0% (Factory Default)</td> <td>80.0%</td> </tr> </tbody> </table>	OUT-08 AO3 Gain		100.0% (Factory Default)	80.0%											
OUT-08 AO3 Gain																
100.0% (Factory Default)	80.0%															

Code	Description			
	OUT-16 AO3 Bias	0.0% (factory Default)		
		20.0%		

9.3.4 Current Output (4–20 mA/0–20 mA) Using an I/O Expansion Module







If the optional I/O expansion module is installed, the current output (0–20 mA or 4–20 mA) can be produced via terminal AO4. The setting details are identical to those of AO1 analog output terminal.

Group	Code	LCD Display	Parameter Setting		Unit
OUT	20	AO4 Mode	0	Frequency	-
	21	AO4 Gain	-	100.0	%
	22	AO4 Bias	-	0.0	%
	23	AO4 Filter	-	5	ms
	24	AO4 Const %	-	0.0	%
	25	AO4 Monitor	-	0.0	%

9.4 Relay Output and Multi-function Output Terminal Settings

Group	Code	LCD Display	Parameter Setting		Unit
OUT	30	Trip Out Mode	-	010	bit
	31	Relay 1	28	Trip	-
	32	Relay 2	14	Run	-
	33	Q1 Define	1	FDT-1	
	34–36	Relay 3–5	-	-	-
	41	DO Status	-	-	bit

Relay Output and Multi-function Output Terminal Setting Details

Code	Description																				
OUT-30 Trip Out Mode	Set OUT-30 (Trip Out Mode) to enable or disable the fault relay. <table border="1" style="margin-left: 20px;"> <thead> <tr> <th>Bit on</th> <th>Bit off</th> </tr> </thead> <tbody> <tr> <td></td> <td></td> </tr> </tbody> </table>	Bit on	Bit off																		
	Bit on	Bit off																			
																					
	<table border="1" style="margin-left: 20px;"> <thead> <tr> <th colspan="3">Setting option</th> <th>Function</th> </tr> </thead> <tbody> <tr> <td>Bit3</td> <td>Bit2</td> <td>Bit1</td> <td>The top-right corner of the display is 'Bit 1'.</td> </tr> <tr> <td></td> <td></td> <td>✓</td> <td>Operates when a low voltage fault trip occurs.</td> </tr> <tr> <td></td> <td>✓</td> <td></td> <td>Operates when a fault trip other than low voltage occurs.</td> </tr> <tr> <td>✓</td> <td></td> <td></td> <td>Operates when auto restart fails (PRT-08–09).</td> </tr> </tbody> </table>	Setting option			Function	Bit3	Bit2	Bit1	The top-right corner of the display is 'Bit 1'.			✓	Operates when a low voltage fault trip occurs.		✓		Operates when a fault trip other than low voltage occurs.	✓			Operates when auto restart fails (PRT-08–09).
	Setting option			Function																	
Bit3	Bit2	Bit1	The top-right corner of the display is 'Bit 1'.																		
		✓	Operates when a low voltage fault trip occurs.																		
	✓		Operates when a fault trip other than low voltage occurs.																		
✓			Operates when auto restart fails (PRT-08–09).																		
Set output options for the relays and multi-function output terminal Q1.																					
<table border="1" style="margin-left: 20px;"> <thead> <tr> <th>Setting</th> <th>Function</th> </tr> </thead> <tbody> <tr> <td>0 None</td> <td>No output signal</td> </tr> <tr> <td>1 FDT-1</td> <td> <p>Inspects whether the output frequency for the inverter reaches the frequency set by the user. The inverter begins to operate when the condition is met: Absolute value (set frequency - output frequency) < detected frequency width/2. When the detected frequency width is 10 Hz, the FDT-1 output is as shown in the graph below.</p> <table border="1" style="margin-left: 20px;"> <thead> <tr> <th>Group</th> <th>Code</th> <th>LCD Display</th> <th>Parameter setting</th> <th>Unit</th> </tr> </thead> <tbody> <tr> <td>OUT</td> <td>58</td> <td>FDT Band (Hz)</td> <td>- 10.00</td> <td>Hz</td> </tr> </tbody> </table> </td> </tr> </tbody> </table>	Setting	Function	0 None	No output signal	1 FDT-1	<p>Inspects whether the output frequency for the inverter reaches the frequency set by the user. The inverter begins to operate when the condition is met: Absolute value (set frequency - output frequency) < detected frequency width/2. When the detected frequency width is 10 Hz, the FDT-1 output is as shown in the graph below.</p> <table border="1" style="margin-left: 20px;"> <thead> <tr> <th>Group</th> <th>Code</th> <th>LCD Display</th> <th>Parameter setting</th> <th>Unit</th> </tr> </thead> <tbody> <tr> <td>OUT</td> <td>58</td> <td>FDT Band (Hz)</td> <td>- 10.00</td> <td>Hz</td> </tr> </tbody> </table>	Group	Code	LCD Display	Parameter setting	Unit	OUT	58	FDT Band (Hz)	- 10.00	Hz					
Setting	Function																				
0 None	No output signal																				
1 FDT-1	<p>Inspects whether the output frequency for the inverter reaches the frequency set by the user. The inverter begins to operate when the condition is met: Absolute value (set frequency - output frequency) < detected frequency width/2. When the detected frequency width is 10 Hz, the FDT-1 output is as shown in the graph below.</p> <table border="1" style="margin-left: 20px;"> <thead> <tr> <th>Group</th> <th>Code</th> <th>LCD Display</th> <th>Parameter setting</th> <th>Unit</th> </tr> </thead> <tbody> <tr> <td>OUT</td> <td>58</td> <td>FDT Band (Hz)</td> <td>- 10.00</td> <td>Hz</td> </tr> </tbody> </table>	Group	Code	LCD Display	Parameter setting	Unit	OUT	58	FDT Band (Hz)	- 10.00	Hz										
Group	Code	LCD Display	Parameter setting	Unit																	
OUT	58	FDT Band (Hz)	- 10.00	Hz																	
OUT-31 Relay1, OUT-32, Relay2, OUT-33 Q1 Define, OUT-34–36 Relay 3–5																					

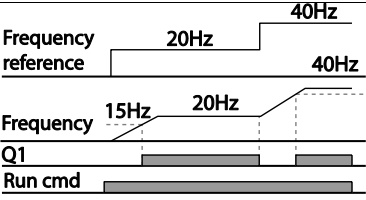
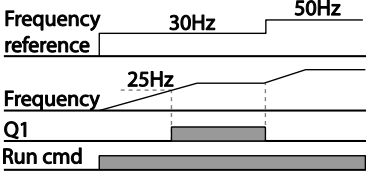
Code	Description																		
																			
2	FDT-2	<p>Outputs a signal when the set frequency and detected frequency (FDT frequency) are equal, and fulfills the FDT-1 condition at the same time: [Absolute value (set frequency – detected frequency) < detected frequency width / 2] & [FDT-1] condition is met</p> <p>The detected frequency width is 10 Hz. When the detected frequency is set to 30 Hz, the FDT-2 output is as shown in the graph below.</p> <table border="1" data-bbox="468 695 947 810"> <thead> <tr> <th>Group</th> <th>Code</th> <th>LCD Display</th> <th colspan="2">Parameter setting</th> <th>Unit</th> </tr> </thead> <tbody> <tr> <td rowspan="2">OUT</td> <td>57</td> <td>FDT Frequency</td> <td>-</td> <td>30.00</td> <td>Hz</td> </tr> <tr> <td>58</td> <td>FDT Band (Hz)</td> <td>-</td> <td>10.00</td> <td>Hz</td> </tr> </tbody> </table> 	Group	Code	LCD Display	Parameter setting		Unit	OUT	57	FDT Frequency	-	30.00	Hz	58	FDT Band (Hz)	-	10.00	Hz
Group	Code	LCD Display	Parameter setting		Unit														
OUT	57	FDT Frequency	-	30.00	Hz														
	58	FDT Band (Hz)	-	10.00	Hz														
3	FDT-3	<p>Outputs a signal when the operating frequency meets the following condition: Absolute value (detected frequency – output frequency) < detected frequency width / 2</p> <table border="1" data-bbox="468 1118 947 1187"> <thead> <tr> <th>Group</th> <th>Code</th> <th>LCD Display</th> <th colspan="2">Initial Setting</th> <th>Unit</th> </tr> </thead> <tbody> <tr> <td rowspan="2">OUT</td> <td>57</td> <td>FDT Frequency</td> <td>-</td> <td>30.00</td> <td>Hz</td> </tr> <tr> <td>58</td> <td>FDT Band (Hz)</td> <td>-</td> <td>10.00</td> <td>Hz</td> </tr> </tbody> </table>	Group	Code	LCD Display	Initial Setting		Unit	OUT	57	FDT Frequency	-	30.00	Hz	58	FDT Band (Hz)	-	10.00	Hz
Group	Code	LCD Display	Initial Setting		Unit														
OUT	57	FDT Frequency	-	30.00	Hz														
	58	FDT Band (Hz)	-	10.00	Hz														

Using Monitor Functions

Code	Description															
		<p>Frequency</p> <p>Q1</p> <p>Run cmd</p>														
4	FDT-4	<p>The output signal can be separately set for acceleration and deceleration conditions.</p> <ul style="list-style-type: none"> In acceleration: Operation frequency \geq Detected frequency In deceleration: Operation frequency $>$ (Detected frequency - Detected frequency width/2) <p>Detected frequency width is 10 Hz. When the detected frequency is set to 30 Hz, FDT-4 output is as shown in the graph below.</p> <table border="1"> <thead> <tr> <th>Group</th> <th>Code</th> <th>LCD Display</th> <th>Parameter setting</th> <th>Unit</th> </tr> </thead> <tbody> <tr> <td rowspan="2">OUT</td> <td>57</td> <td>FDT Frequency</td> <td>- 30.00</td> <td>Hz</td> </tr> <tr> <td>58</td> <td>FDT Band (Hz)</td> <td>- 10.00</td> <td>Hz</td> </tr> </tbody> </table> <p>Frequency</p> <p>Q1</p> <p>Run cmd</p>	Group	Code	LCD Display	Parameter setting	Unit	OUT	57	FDT Frequency	- 30.00	Hz	58	FDT Band (Hz)	- 10.00	Hz
Group	Code	LCD Display	Parameter setting	Unit												
OUT	57	FDT Frequency	- 30.00	Hz												
	58	FDT Band (Hz)	- 10.00	Hz												
5	Over Load	Outputs a signal at motor overload.														
6	IOL	Outputs a signal when the inverter input current exceeds the rated current and a protective function is activated to prevent damage to the inverter, based on inverse proportional characteristics.														
7	Under Load	Outputs a signal at load fault warning.														
8	Fan Warning	Outputs a signal at fan fault warning.														
9	Stall	Outputs a signal when a motor is overloaded and stalled.														
10	Over Voltage	Outputs a signal when the inverter DC link voltage rises above the protective operation voltage.														
11	Low Voltage	Outputs a signal when the inverter DC link voltage drops below the low voltage protective level.														
12	Over Heat	Outputs signal when the inverter overheats.														
13	Lost Command	Outputs a signal when there is a loss of analog input terminal and RS-485 communication command at the terminal block. Outputs a signal when communication power is present and an I/O expansion module is installed. It also outputs a signal														

Code	Description																								
		when losing analog input and communication power commands.																							
14	RUN	<p>Outputs a signal when an operation command is entered and the inverter outputs voltage. No signal output during DC braking.</p> <p>Frequency</p> <p>Q1</p> <p>Run cmd</p>																							
15	Stop	Outputs a signal at operation command off, and when there is no inverter output voltage.																							
16	Steady	Outputs a signal in steady operation.																							
17	Inverter Line	Outputs a signal while the motor is driven by the inverter line.																							
18	Comm Line	<p>Outputs a signal when multi-function input terminal (switching) is entered.</p> <table border="1"> <thead> <tr> <th>Group</th> <th>Code</th> <th>LCD Display</th> <th colspan="2">Initial Setting</th> <th>Unit</th> </tr> </thead> <tbody> <tr> <td>IN</td> <td>65-72</td> <td>Px Define</td> <td>16</td> <td>Exchange</td> <td>-</td> </tr> <tr> <td rowspan="2">OUT</td> <td>32</td> <td>Relay 2</td> <td>15</td> <td>Inverter Line</td> <td>-</td> </tr> <tr> <td>33</td> <td>Q1 Define</td> <td>16</td> <td>Comm Line</td> <td>-</td> </tr> </tbody> </table> <p>For details, refer to 8.23 Supply Power Transition on page 253.</p>	Group	Code	LCD Display	Initial Setting		Unit	IN	65-72	Px Define	16	Exchange	-	OUT	32	Relay 2	15	Inverter Line	-	33	Q1 Define	16	Comm Line	-
Group	Code	LCD Display	Initial Setting		Unit																				
IN	65-72	Px Define	16	Exchange	-																				
OUT	32	Relay 2	15	Inverter Line	-																				
	33	Q1 Define	16	Comm Line	-																				
19	Speed Search	Outputs a signal during inverter speed search operation. For details, refer to 8.19 Speed Search Operation on page 244.																							
20	Step Pulse	Outputs a signal when a step is completed in an auto sequence operation.																							
21	Seq Pulse	Outputs a signal when a sequence is completed in an auto sequence operation.																							
22	Ready	Outputs a signal when the inverter is in standby mode and ready to receive external operation commands.																							
23	Trv ACC	<p>Outputs a signal when the inverter reaches the accelerating frequency during a traverse operation.</p> <table border="1"> <thead> <tr> <th>Group</th> <th>Code</th> <th>LCD Display</th> <th colspan="2">Parameter setting</th> <th>Unit</th> </tr> </thead> <tbody> <tr> <td>APP</td> <td>01</td> <td>App Mode</td> <td>1</td> <td>Traverse</td> <td>-</td> </tr> </tbody> </table>	Group	Code	LCD Display	Parameter setting		Unit	APP	01	App Mode	1	Traverse	-											
Group	Code	LCD Display	Parameter setting		Unit																				
APP	01	App Mode	1	Traverse	-																				
24	Trv DEC	<p>Outputs a signal when the inverter reaches the decelerating frequency during a traverse operation.</p> <table border="1"> <thead> <tr> <th>Group</th> <th>Code</th> <th>LCD Display</th> <th colspan="2">Parameter setting</th> <th>Unit</th> </tr> </thead> <tbody> <tr> <td>APP</td> <td>01</td> <td>App Mode</td> <td>1</td> <td>Traverse</td> <td>-</td> </tr> </tbody> </table>	Group	Code	LCD Display	Parameter setting		Unit	APP	01	App Mode	1	Traverse	-											
Group	Code	LCD Display	Parameter setting		Unit																				
APP	01	App Mode	1	Traverse	-																				

Using Monitor Functions

Code	Description																					
25	MMC	<p>Used as a multi-motor control function. By configuring the relay output and the multi-function output to MMC and configuring the APP-01 (APP Mode) to "3 (MMC)", it can conduct the necessary operations for multi-motor control function.</p> <table border="1"> <thead> <tr> <th>Group</th> <th>Code</th> <th>LCD Display</th> <th>Parameter setting</th> <th>Unit</th> </tr> </thead> <tbody> <tr> <td>APP</td> <td>01</td> <td>App Mode</td> <td>3 MMC</td> <td>-</td> </tr> </tbody> </table>	Group	Code	LCD Display	Parameter setting	Unit	APP	01	App Mode	3 MMC	-										
Group	Code	LCD Display	Parameter setting	Unit																		
APP	01	App Mode	3 MMC	-																		
26	Zspd Dect	<p>Detects if the motor's rotation speed is 0 rpm during operation and if the control mode is set as a vector.</p> <table border="1"> <thead> <tr> <th>Group</th> <th>Code</th> <th>LCD Display</th> <th>Parameter setting</th> <th>Unit</th> </tr> </thead> <tbody> <tr> <td>DRV</td> <td>09</td> <td>Control Mode</td> <td>4 Vector</td> <td>-</td> </tr> <tr> <td>CON</td> <td>82</td> <td>ZSD Frequency</td> <td>- 2.00</td> <td>Hz</td> </tr> <tr> <td></td> <td>83</td> <td>ZSD Band (Hz)</td> <td>- 1.00</td> <td>Hz</td> </tr> </tbody> </table> <p>As the relay operation is dependent on the motor number (encoder signal), a fault may occur when turning the inverter on or off due to the encoder signal noise or filter time constant.</p>	Group	Code	LCD Display	Parameter setting	Unit	DRV	09	Control Mode	4 Vector	-	CON	82	ZSD Frequency	- 2.00	Hz		83	ZSD Band (Hz)	- 1.00	Hz
Group	Code	LCD Display	Parameter setting	Unit																		
DRV	09	Control Mode	4 Vector	-																		
CON	82	ZSD Frequency	- 2.00	Hz																		
	83	ZSD Band (Hz)	- 1.00	Hz																		
27	Torque Dect	<p>Outputs a signal if the torque, with the control mode set as sensorless or vector, is below the following levels.</p> <table border="1"> <thead> <tr> <th>Group</th> <th>Code</th> <th>LCD Display</th> <th>Parameter setting</th> <th>Unit</th> </tr> </thead> <tbody> <tr> <td>DRV</td> <td>09</td> <td>Control Mode</td> <td>3–4 Sensorless-1, Sensorless-2, Vector</td> <td>-</td> </tr> <tr> <td>OUT</td> <td>59</td> <td>TD Level</td> <td>- 100.0</td> <td>%</td> </tr> <tr> <td></td> <td>60</td> <td>TD Band</td> <td>- 5.0</td> <td>%</td> </tr> </tbody> </table>	Group	Code	LCD Display	Parameter setting	Unit	DRV	09	Control Mode	3–4 Sensorless-1, Sensorless-2, Vector	-	OUT	59	TD Level	- 100.0	%		60	TD Band	- 5.0	%
Group	Code	LCD Display	Parameter setting	Unit																		
DRV	09	Control Mode	3–4 Sensorless-1, Sensorless-2, Vector	-																		
OUT	59	TD Level	- 100.0	%																		
	60	TD Band	- 5.0	%																		
28	Timer Out	<p>A timer function to operate terminal output after a certain time by using multi-function terminal block input.</p> <table border="1"> <thead> <tr> <th>Group</th> <th>Code</th> <th>LCD Display</th> <th>Parameter setting</th> <th>Unit</th> </tr> </thead> <tbody> <tr> <td>IN</td> <td>65–72</td> <td>Px Define</td> <td>38 Timer In</td> <td>-</td> </tr> <tr> <td>OUT</td> <td>55</td> <td>Timer On Delay</td> <td>- 0.00</td> <td>Sec</td> </tr> <tr> <td></td> <td>56</td> <td>Timer Off Delay</td> <td>- 0.00</td> <td>Sec</td> </tr> </tbody> </table>	Group	Code	LCD Display	Parameter setting	Unit	IN	65–72	Px Define	38 Timer In	-	OUT	55	Timer On Delay	- 0.00	Sec		56	Timer Off Delay	- 0.00	Sec
Group	Code	LCD Display	Parameter setting	Unit																		
IN	65–72	Px Define	38 Timer In	-																		
OUT	55	Timer On Delay	- 0.00	Sec																		
	56	Timer Off Delay	- 0.00	Sec																		
32	ENC Tune	Outputs a warning signal by releasing the contact point output																				







Code	Description	
		if autotuning is performed, if there is no encoder board, or if APO-01 Enc Opt mode is not set to "Feedback".
	33	ENC Dir Outputs a warning signal when the motor rotation direction by the encoder is not set properly. The warning signal is generated when then encoder wiring is not made properly even if the encoder module has been installed and APO-01 Enc Opt Mode is set to "Feedback".
	36	KEB Operating Outputs a signal when the energy buffering operation is performed (when an input power outage occurs and the DC power supply voltage of the inverter is low).
	37	Fire Mode Outputs a signal when Fire mode is in operation only if ADV-80 is set to Fire mode.
	38	Run2 It operates when the operation command is input or the inverter is outputting voltage. Unlike "14: Run", it operates even during DC braking
OUT-41 DO State	Used to check On/Off state of the DO (digital output) by each bit.	

9.5 Fault trip output using multi-function output terminals and relays

The inverter can output a fault trip state using the multi-function output terminal (Q1) and relay (Relay1).

Group	Code	LCD Display	Parameter Setting		Unit
OUT	30	Trip Out Mode	-	010	
	31	Relay 1	29	Trip	-
	32	Relay 2	14	Run	-
	33	Q1 Define	1	FDT-1	-
	53	Trip Out On Dly	-	0.00	Sec
	54	Trip Out Off Dly	-	0.00	Sec

* The inverter can output a fault trip status using expansion digital output terminals (OUT 34–36) if the optional I/O expansion module is installed.

Code	Description																			
OUT-30 Trip Out Mode	Set OUT-30 (Trip Out Mode) to enable or disable the fault relay.																			
	<table border="1"> <thead> <tr> <th>Bit on</th> <th>Bit off</th> </tr> </thead> <tbody> <tr> <td></td> <td></td> </tr> </tbody> </table>	Bit on	Bit off																	
	Bit on	Bit off																		
																				
	Depending on the fault trip type, the terminal and relay operation can be configured as shown in the table below.																			
<table border="1"> <thead> <tr> <th colspan="3">Setting option</th> <th>Function</th> </tr> </thead> <tbody> <tr> <td>Bit3</td> <td>Bit2</td> <td>Bit1</td> <td>The top-right corner of the display is 'Bit 1'.</td> </tr> <tr> <td></td> <td></td> <td>✓</td> <td>Operates when a low voltage fault trip occurs.</td> </tr> <tr> <td></td> <td>✓</td> <td></td> <td>Operates when a fault trip other than low voltage occurs.</td> </tr> <tr> <td>✓</td> <td></td> <td></td> <td>Operates when auto restart fails (PRT-08–09).</td> </tr> </tbody> </table>	Setting option			Function	Bit3	Bit2	Bit1	The top-right corner of the display is 'Bit 1'.			✓	Operates when a low voltage fault trip occurs.		✓		Operates when a fault trip other than low voltage occurs.	✓			Operates when auto restart fails (PRT-08–09).
Setting option			Function																	
Bit3	Bit2	Bit1	The top-right corner of the display is 'Bit 1'.																	
		✓	Operates when a low voltage fault trip occurs.																	
	✓		Operates when a fault trip other than low voltage occurs.																	
✓			Operates when auto restart fails (PRT-08–09).																	
OUT-31–33	Select the terminal and relay to use for failure output and set OUT-31–33 to "28 (Trip mode)". When a fault trip occurs in the inverter, the relevant terminal and relay will operate.																			
OUT-53 Trip Out On Dly, OUT-54 Trip Out Off Dly,	If a fault trip occurs, trip relay or multi-function output operates after the time delay set in OUT-53. The terminal turns off with the input initialized after the time delay set in OUT-54.																			

9.6 Output Terminal Delay Time and Terminal Types

You can adjust the operating time of the output terminals and relays. The ON and OFF delay time can be set separately. You can choose between “form A” terminal (Normally Open) and “form B” terminal (Normally Closed).

9.6.1 Output Terminal Delay Time

Group	Code	LCD Display	Parameter Setting		Unit
OUT	50	DO On Delay	-	0.00	Sec
	51	DO Off Delay	-	0.00	Sec

Output Terminal Delay Time Setting Details

Code	Description
OUT-50 DO On Delay	Set the delay time before the output signal is turned on.
OUT-51 DO Off Delay	Set the delay time before the output signal is turned off.

The delay time set at codes OUT-50 and OUT-51 apply to the multi-function output terminal (Q1) and relays (Relay 1 and 2), except when the multi-function output function is in fault trip mode.

9.6.2 Setting the Output Terminal Type

Group	Code	LCD Display	Parameter Setting		Unit
OUT	52	DO NC/NO Sel	-	000	bit

Output Terminal Type Setting Details

Code	Description
OUT-52 DO NC/NO Sel	<p>Select the type for the relay and multi-function output terminal. An additional three terminal type selection bits at the terminal block will be added when an optional I/O expansion module is installed.</p> <p>Set the relevant bit to "0" to operate it as a "form A" terminal (Normally Open), "1" to operated it as a "form B" terminal (Normally Closed). Relay 1 and Q1 settings start from the right bit (The top-right corner of the display is 'Bit 1').</p>

9.7 Operation Time Monitor

Group	Code	LCD Display	Parameter Setting		Unit
CNF	70	On-time	-	0000DAY 00hr:00mm	-
	71	Run-time	-	0000DAY 00hr:00mm	-
	72	Time Reset	0	No	-
	74	Fan Time	-	0000DAY 00hr:00mm	-
	75	Fan Time Reset	0	No	-

Output Terminal Type Setting Details

Code	Description
CNF-70 On-time	Displays the accumulated power supply time. Information is displayed in [0000DAY 00hr:00mm] format.
CNF-71 Run-time	Displays the accumulated time of voltage output by operation command input. Information is displayed in [0000DAY 00hr:00mm] format.
CNF-72 Time Reset	Setting "1 (Yes)" will delete the accumulated power supply time (On-time) and operation accumulated time (Run-time), and is displayed in 0000DAY 00hr:00mm format.
CNF-74 Fan time	Displays the accumulated inverter cooling fan operation time. Information will be displayed in [0000DAY 00hr:00mm] format.
CNF-75 Fan Time Reset	Setting "1 (Yes)" will delete the accumulated cooling fan operation time (on-time) and accumulated operation time (run-time), and will display it in 0/00/00 00:00 format.

9.8 Setting the Keypad Language

Select the language to be displayed on the LCD keypad. Keypads using SW Ver 1.04 and later provide a language selection. The Korean language setting supports Korean and English.

Group	Code	LCD Display	Initial Setting		Unit
CNF	01	Language Sel	0	English	-
			1	Russian	
			2	Spanish	
			3	Italian	
			4	Turkish	

10 Using Protection Features

Protection features provided by the SV-iS7 series inverter are categorized into two types: Protection from damage due to an overheating motor and Protection against inverter malfunction.

10.1 Motor Protection

10.1.1 Electrothermal Motor Overheating Prevention (ETH)

ETH is a protective function that uses the output current of an inverter without a separate temperature sensor to predict increases in motor temperature and protect the motor, based on its heat characteristics.

Group	Code	LCD Display	Parameter Setting		Setting Range	Unit
PRT	40	ETH Trip Sel	0	None	None/Free-Run/Dec	-
	41	Motor Cooling	0	Self-cool	-	-
	42	ETH 1min	-	150	120-200	%
	43	ETH Cont	-	120	50-180	%

Electronic Thermal (ETH) Prevention Function Setting Details

Code	Description									
PRT-40 ETH Trip Sel	ETH can be selected to provide motor thermal protection. The LCD screen displays "E-Thermal."									
	<table border="1"> <thead> <tr> <th>Setting</th> <th>Function</th> </tr> </thead> <tbody> <tr> <td>0</td> <td>None</td> </tr> <tr> <td>1</td> <td>Free-Run</td> </tr> <tr> <td>2</td> <td>Dec</td> </tr> </tbody> </table>		Setting	Function	0	None	1	Free-Run	2	Dec
	Setting	Function								
	0	None								
1	Free-Run									
2	Dec									
0	None	The ETH function is not activated.								
1	Free-Run	The inverter output is blocked. The motor coasts to a halt (free-run).								
2	Dec	The inverter decelerates the motor to a stop.								
PRT-41 Motor Cooling	Select the drive mode of the cooling fan, attached to the motor.									
	<table border="1"> <thead> <tr> <th>Setting</th> <th>Function</th> </tr> </thead> <tbody> <tr> <td>0</td> <td>Self-cool</td> </tr> <tr> <td>1</td> <td>Forced-cool</td> </tr> </tbody> </table>		Setting	Function	0	Self-cool	1	Forced-cool		
	Setting	Function								
	0	Self-cool								
1	Forced-cool									
0	Self-cool	As the cooling fan is connected to the motor axis, the cooling effect varies based on motor speed. Most universal induction motors have this design.								
1	Forced-cool	Additional power is supplied to operate the cooling fan. This provides expansion operation at low speeds. Motors designed for inverters typically have this design.								

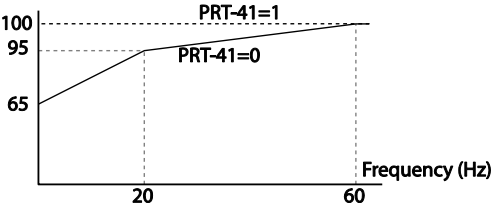
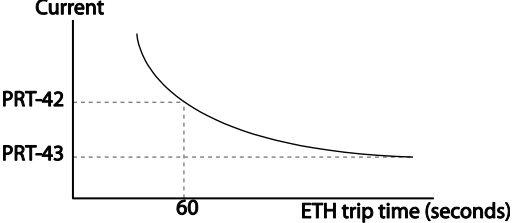
Code	Description
	<p>Continuous rated current (%)</p> 
PRT-42 ETH 1 min	The amount of input current that can be continuously supplied to the motor for 1 minute, based on the motor-rated current (BAS-13).
PRT-43 ETH Cont	<p>Sets the amount of current with the ETH function activated. The range below details the set values that can be used during continuous operation without the protection function.</p> 

10.1.2 Overload Early Warning and Trip

A warning or fault trip (cutoff) occurs when the motor reaches an overload state, based on the motor-rated current. The amount of current for warnings and trips can be set separately.

Group	Code	LCD Display	Parameter Setting		Setting Range	Unit
PRT	04	Load Duty	1	Heavy Duty	-	-
	17	OL Warn Select	1	Yes	0–1	-
	18	OL Warn Level	-	150	30–180	%
	19	OL Warn Time	-	10.0	0–30	sec
	20	OL Trip Select	1	Free-Run	-	-
	21	OL Trip Level	-	180	30–200	%
	22	OL Trip Time	-	60.0	0–60.0	sec
OUT	31	Relay 1	5	Over Load	-	-
	32	Relay 2			-	
	33	Q1 Define			-	

Overload Early Warning and Trip Setting Details

Code	Description						
PRT-04 Load Duty	Select the load level.						
	<table border="1"> <thead> <tr> <th>Setting</th> <th>Function</th> </tr> </thead> <tbody> <tr> <td>0 Normal Duty</td> <td>Use this setting for light loads, such as, fans and pumps (overload tolerance: 110% of rated underload current for 1 minute).</td> </tr> <tr> <td>1 Heavy Duty</td> <td>Use this setting for heavy loads, such as, cranes and parking elevators (overload tolerance: 150% of rated heavy load current for 1 minute).</td> </tr> </tbody> </table>	Setting	Function	0 Normal Duty	Use this setting for light loads, such as, fans and pumps (overload tolerance: 110% of rated underload current for 1 minute).	1 Heavy Duty	Use this setting for heavy loads, such as, cranes and parking elevators (overload tolerance: 150% of rated heavy load current for 1 minute).
	Setting	Function					
0 Normal Duty	Use this setting for light loads, such as, fans and pumps (overload tolerance: 110% of rated underload current for 1 minute).						
1 Heavy Duty	Use this setting for heavy loads, such as, cranes and parking elevators (overload tolerance: 150% of rated heavy load current for 1 minute).						
PRT-17 OL Warn Select	If the overload reaches the warning level, the terminal block multi-function output terminal and relay are used to output a warning signal. If “1 (Yes)” is selected, it will operate. If “0 (No)” is selected, it will not operate.						
PRT-18 OL Warn Level, PRT-19 OL Warn Time	When the input current to the motor is greater than the overload warning level (OL Warn Level) and continues at that level during the overload warning time (OL Warn Time), the multi-function output (Relay 1, Q1) sends a warning signal. When Over Load is selected at OUT-31 and OUT-33, the multi-function output terminal or relay outputs a signal. The signal output does not block the inverter output.						
PRT-20 OL Trip Select	Select the inverter protective action in the event of an overload fault trip.						
	<table border="1"> <thead> <tr> <th>Setting</th> <th>Function</th> </tr> </thead> <tbody> <tr> <td>0 None</td> <td>No protective action is taken.</td> </tr> </tbody> </table>	Setting	Function	0 None	No protective action is taken.		
	Setting	Function					
0 None	No protective action is taken.						

Code	Description		
PRT-21 OL Trip Level, PRT-22 OL Trip Time	1	Free-Run	In the event of an overload fault, inverter output is blocked and the motor will free-run due to inertia.
	3	Dec	If a fault trip occurs, the motor decelerates and stops.
			When the current supplied to the motor is greater than the preset value of the overload trip level (OL Trip Level) and continues to be supplied during the overload trip time (OL Trip Time), the inverter output is either blocked according to the preset mode from PRT-17 or slows to a stop after deceleration.

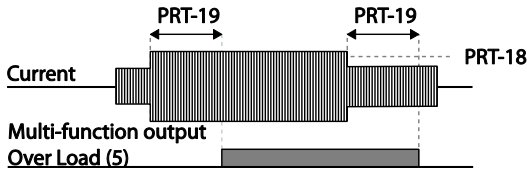

Note

Overload warnings warn of an overload before an overload fault trip occurs. The overload warning signal may not work in an overload fault trip situation, if the overload warning level (OL Warn Level) and the overload warning time (OL Warn Time) are set higher than the overload trip level (OL Trip Level) and the overload trip time (OL Trip Time).

10.13 Stall Prevention and Flux Braking

The stall prevention function is a protective function that prevents motors from stalling due to overloads. If a motor stall occurs due to an overload, the inverter operation frequency is adjusted automatically. When a stall is caused by overload, high currents induced in the motor may cause motor overheating or damage the motor and interrupt operation of the motor-driven devices.

In this case, the motor decelerates with optimum deceleration without a braking resistor by using flux braking. If the deceleration time is too short, an over voltage fault trip may occur because of regenerative energy from the motor. The flux braking makes the motor use regenerate energy, therefore optimum deceleration is available without over voltage fault trip.

Using Protection Features

To protect the motor from overload faults, the inverter output frequency is adjusted automatically, based on the size of load.

Group	Code	LCD Display	Parameter Setting		Setting Range	Unit
PRT	50	Stall Prevent & Flux Braking	-	0 0000	-	Bit
	51	Stall Freq 1	-	60.00	Starting Freq–Stall Freq 1	Hz
	52	Stall Level 1	-	180	30–250	%
	53	Stall Freq 2	-	60.00	Stall Freq 1–Stall Freq 3	Hz
	54	Stall Level 2	-	180	30–250	%
	55	Stall Freq 3	-	60.00	Stall Freq 2–Stall Freq 4	Hz
	56	Stall Level 3	-	180	30–250	%
	57	Stall Freq 4	-	60.00	Stall Freq 3–Max. Freq	Hz
58	Stall Level 4	-	180	30–250	%	
OUT	31–33	Relay1,2, Q1	9	Stall	-	-

Stall Prevention Function and Flux Braking Setting Details

Code	Description					
PRT-50 Stall Prevent	Stall prevention can be configured for acceleration, deceleration, or while operating a motor at constant speed. When the LCD segment is on, the corresponding bit is off.					
	Item	Bit Status (On)			Bit Status (Off)	
	Keypad display					
	Setting			Function		
	Bit5	Bit 4	Bit 3	Bit 2	Bit 1	
				✓	Stall protection during acceleration	
			✓		Stall protection while operating at a constant speed	
	✓				Stall protection during deceleration	
		✓			Flux braking during deceleration	
✓					Stall protection during acceleration & constant speed	
Setting			Function			
0 0001	Stall protection during acceleration		If the inverter output current exceeds the preset stall level (PRT-52, 54, 56, 58) during acceleration, the motor stops accelerating and starts decelerating. If current level stays above the stall level, the motor decelerates to the start frequency (DRV-19). If the current level causes			

Code	Description	
		deceleration below the preset level while operating the stall protection function, the motor resumes acceleration.
1 0001	Stall prevention during acceleration (Mode2)	If the inverter's output current exceeds the preset stall level (PRT-52, 54...) during acceleration, the inverter adjusts the output frequency to prevent stalling. The inverter performs a PI control on the current level to adjust the output frequency to be above the stall level. While the stall prevention feature is activated, the inverter starts accelerating again when the the current drops below the the set level.
0 0010	Stall protection while operating at constant speed	Similar to stall protection function during acceleration, the output frequency automatically decelerates when the current level exceeds the preset stall level while operating at constant speed. When the load current decelerates below the preset level, it resumes acceleration.
1 0010	Stall prevention while operating at a constant speed (Mode2)	Similar to the stall protection function during acceleration (Mode 2), if the inverter output current exceeds the preset stall level while operating at a constant speed, the inverter adjusts the output frequency according to the load current. When the load current drops below the preset level, the inverter resumes acceleration.
1 or 0 0100	Stall protection during deceleration	The inverter decelerates and keeps the DC link voltage below a certain level to prevent an over voltage fault trip during deceleration. As a result, deceleration times can be longer than the set time depending on the load.
1 or 0 1000	Flux braking during deceleration	When using flux braking, deceleration time may be reduced because regenerative energy is expended at the motor.
1 or 0 1100	Stall protection and flux braking during deceleration	Stall protection and flux braking operate together during deceleration to achieve the shortest and most stable deceleration performance.

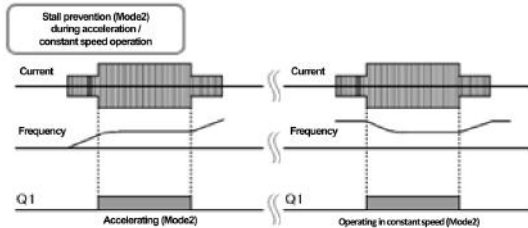

Mode2: The frequency is adjusted according to the stall level setting and load current.

Using Protection Features

Code	Description
	<div data-bbox="269 268 796 507"> <p>Stall prevention (Mode1) during acceleration / constant speed operation</p> <p>Model1: Decelerates to the start frequency according to the stall level setting.</p> </div> <div data-bbox="269 523 628 762"> <p>Stall Prevention during deceleration</p> <p>Decelerating</p> </div>
<p>PRT-51 Stall Freq 1– PRT-58 Stall Level 4</p>	<p>Additional stall protection levels can be configured for different frequencies, based on the load type. As shown in the graph below, the stall level can be set above the base frequency. The lower and upper limits are set using numbers that correspond in ascending order. For example, the range for Stall Frequency 2 (Stall Freq 2) becomes the lower limit for Stall Frequency 1 (Stall Freq 1) and the upper limit for Stall Frequency 3 (Stall Freq 3).</p> <div data-bbox="269 906 916 1193"> <p>Stall level</p> <p>Stall level 1 Stall level 2 Stall level 3 Stall level 4</p> <p>Stall Frq1 Stall Frq2 Stall Frq3 Stall Frq4</p> <p>Output Frequency</p> </div>

Note

Stall protection and flux braking operate together only during deceleration. Turn on the third and fourth bits of PRT-50 (Stall Prevention) to achieve the shortest and most stable deceleration performance without triggering an over voltage fault trip for loads with high inertia and short deceleration times. Do not use this function when frequent deceleration of the load is required, as the motor can overheat and be easily damaged.

ⓘ Caution

- Use caution when decelerating while using stall protection since the deceleration time can take longer than the time set, depending on the load. Acceleration stops when stall protection operates during acceleration. This may make the actual acceleration time longer than the preset acceleration time.
- When the motor is operating, Stall Level 1 applies and determines the operation of stall protection.

10.14 Motor Overheat Sensor Input

To use the motor overheat protection, connect the overheat protection temperature sensor (PT 100, PTC) installed in the motor to the inverter's analog input terminal.

Group	Code	LCD Display	Parameter Setting		Setting Range	Unit
PRT	34	Thermal-T Sel	1	Free-Run	-	-
	35	Thermal In Src	1	V1	-	-
	36	Thermal-T Lev	-	50.0	0–100	%
	37	Thermal-T Area	0	Low	Low/High	-
OUT	07	AO2 Mode	14	Constant	-	-
	08	AO2 Const	11	100%	0–100	%
IN	65–75	Px Define	39	Thermal In	-	-
	87	DI NC/NO Sel	-	-	-	-

Motor Overheat Sensor Input Details

Code	Description
PRT-34 Thermal-T Sel	The inverter operating status is set when the motor overheats. If Free-Run (1) is set, the inverter output will be blocked. If decelerating stop (2) is set and the overheat sensor detects overheating, the inverter will decelerate and stop.
PRT-35 Thermal In Src	The terminal type is selected when the motor overheat sensor is connected to the voltage (V1) or current (I1) input terminals of the inverter terminal block in the inverter. The voltage (V2) or current (I2) terminals in the I/O expansion module are also available. If you use the current input terminal I1 by supplying constant current to the temperature sensor with the analog current output (AO2) terminal, the switch in the I/O expansion module should be where the PTC is. Before use, check if the switch is at the PTC.

Using Protection Features

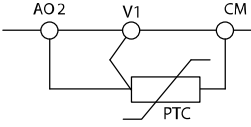
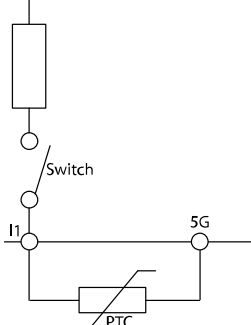
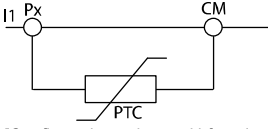
Code	Description
	<div style="display: flex; justify-content: space-around;"> <div style="text-align: center;">  <p>[With voltage (V1) input]</p> </div> <div style="text-align: center;">  <p>[With current (I1) input terminal]</p> </div> </div> <p>Temperature is measured by letting a certain amount of current flow through the AO2 terminal and converting it into voltage depending on the resistance value change.</p>
<p>IN-65-72 Px Define, IN-82 DI NC/NO Sel</p>	<p>You can set the overheat trip function input using the multi-function terminal block input when using a bimetal-type sensor relay. Connect PTC between the terminal block to use and CM and select "39 (Thermal)" In among the function items. Select the type of contact point of the terminal used in IN-87 as "1 (NC)".</p> <div style="text-align: center;">  </div> <p>[Configuration using multi-function input terminals]</p>
<p>PRT-36 Thermal-T Lev</p>	<p>Sets the operation level for the motor overheat sensor. For the voltage input terminal (V1), the maximum input voltage is 10 V and for the current (I1), the maximum input voltage is 5 V. For example, if you use the current input terminal and set the failure level to 50%, the protection function is performed when the voltage supplied to the I1 terminal is below 2.5 V. To perform the protection function when the voltage supplied to the I1 terminal is above 2.5 V, refer to the PRT-37 Thermal-T Area.</p>
<p>PRT-37 Thermal-T Area</p>	<p>If Low (0) is set and the motor overheat sensor input is smaller than PRT-36, the protection function is performed. If High (1) is set and the motor overheat sensor input is bigger than PRT-36, the protection function is performed.</p>













10.2 Inverter and Sequence Protection

10.2.1 Open-phase Protection

Open-phase protection is used to prevent overcurrent levels induced at the inverter inputs due to an open-phase within the input power supply. Open-phase output protection is also available. An open phase at the connection between the motor and the inverter may cause the motor to stall, due to a lack of torque.

Group	Code	LCD Display	Parameter Setting		Setting Range	Unit
PRT	05	Phase Loss Chk	-	10	-	Bit
	06	IPO V Band	-	40	1–100	V

Input and Output Open-phase Protection Setting Details

Code	Description																	
PRT-05 Phase Loss Chk	When open-phase protection is operating, input and output configurations are displayed differently. When the LCD segment is On, the corresponding bit is set to 'Off'.																	
	<table border="1"> <thead> <tr> <th>Item</th> <th>Bit status (On)</th> <th>Bit status (Off)</th> </tr> </thead> <tbody> <tr> <td>Keypad display</td> <td></td> <td></td> </tr> </tbody> </table>	Item	Bit status (On)	Bit status (Off)	Keypad display													
	Item	Bit status (On)	Bit status (Off)															
	Keypad display																	
	<table border="1"> <thead> <tr> <th colspan="2">Setting</th> <th rowspan="2">Keypad display</th> <th rowspan="2">Function</th> </tr> <tr> <th>Bit 2</th> <th>Bit 1</th> </tr> </thead> <tbody> <tr> <td></td> <td>✓</td> <td></td> <td>Output open-phase protection. If one or more than one phase from U, V, and W is open, the inverter output will be blocked and "Out Phase Open" will be displayed on the keypad.</td> </tr> <tr> <td>✓</td> <td></td> <td></td> <td>Input open-phase protection. If one or more phases from R, S, and T are open, the inverter output will be blocked and "In Phase Open" will be displayed on the keypad. Protection against input phase open starts only when a certain amount of current (70–80% of the inverter-rated output current) flows through the motor.</td> </tr> <tr> <td>✓</td> <td>✓</td> <td></td> <td>Input and output open-phase protection</td> </tr> </tbody> </table>	Setting		Keypad display	Function	Bit 2	Bit 1		✓		Output open-phase protection. If one or more than one phase from U, V, and W is open, the inverter output will be blocked and "Out Phase Open" will be displayed on the keypad.	✓			Input open-phase protection. If one or more phases from R, S, and T are open, the inverter output will be blocked and "In Phase Open" will be displayed on the keypad. Protection against input phase open starts only when a certain amount of current (70–80% of the inverter-rated output current) flows through the motor.	✓	✓	
Setting		Keypad display	Function															
Bit 2	Bit 1																	
	✓		Output open-phase protection. If one or more than one phase from U, V, and W is open, the inverter output will be blocked and "Out Phase Open" will be displayed on the keypad.															
✓			Input open-phase protection. If one or more phases from R, S, and T are open, the inverter output will be blocked and "In Phase Open" will be displayed on the keypad. Protection against input phase open starts only when a certain amount of current (70–80% of the inverter-rated output current) flows through the motor.															
✓	✓		Input and output open-phase protection															
PRT-06 IPO V Band	Sets the band of the allowed ripple voltage. If one or more phases from the inverter output are open, the ripple of the DC link voltage increases. If ripple voltage exceeds the set ripple voltage band, an input phase open trip occurs. The IPO V Band may be adjusted depending on the operating environment.																	
	Sets the IPO V Band 1–10 volts higher if the output load is too large for the input capacity, and an open phase fault trip occurs during a normal operation. Sets the IPO V Band 1–10 volts lower if the output load is too smaller for the input capacity.																	

Note

Ensure that the motor-rated current (BAS-13 Rated Curr) is correctly set. Phase open protection may not be operated properly if the motor's rated current is not correctly set at BAS-13.

10.2.2 External Trip Signal

Set one of the multi-function input terminals to "4 (External Trip)" to allow the inverter to stop operation when abnormal operating conditions arise.

Group	Code	LCD Display	Parameter Setting	Unit
IN	65-72	Px Define	4 External Trip	-
	87	DI NC/NO Sel	-  (000 000000)	-

External Trip Signal Setting Details

Code	Description																							
IN-87 DI NC/NO Sel	Select the type of input contact. If the mark of the switch is at the bottom (0), it operates as a form A terminal (Normally Open). If the mark is at the top (1), it operates as a form B terminal (Normally Closed).																							
	The corresponding terminals for each bit are as follows:																							
	<table border="1"> <thead> <tr> <th>Bit</th> <th>11</th> <th>10</th> <th>9</th> <th>8</th> <th>7</th> <th>6</th> <th>5</th> <th>4</th> <th>3</th> <th>2</th> <th>1</th> </tr> </thead> <tbody> <tr> <td>Terminal</td> <td>-</td> <td>-</td> <td>-</td> <td>P8</td> <td>P7</td> <td>P6</td> <td>P5</td> <td>P4</td> <td>P3</td> <td>P2</td> <td>P1</td> </tr> </tbody> </table>	Bit	11	10	9	8	7	6	5	4	3	2	1	Terminal	-	-	-	P8	P7	P6	P5	P4	P3	P2
Bit	11	10	9	8	7	6	5	4	3	2	1													
Terminal	-	-	-	P8	P7	P6	P5	P4	P3	P2	P1													

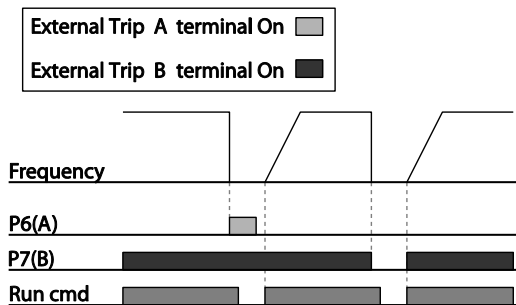

10.2.3 Inverter Overload Protection (IOLT)

If more current than the inverter-rated current flows, the protective function starts to protect the inverter depending on the inverse time characteristic.

Group	Code	LCD Display	Parameter Setting		Unit
OUT	31–33	Relay 1,2, Q1	6	IOL	-

Note

A warning signal output can be provided in advance by the multi-function output terminal before the inverter overload protection function (IOLT) operates. When the overcurrent time reaches 60% of the allowed overcurrent (150%, 1 min), a warning signal output is provided (signal output at 150% for 36 sec).

10.2.4 Keypad Command Loss

When setting operation speed using the keypad, speed command loss setting can be used to select the inverter operation for situations when the speed command from the keypad is lost due to the disconnection of signal cable.

Group	Code	LCD Display	Parameter Setting		Unit
PRT	11	Lost KPD Mode	2	Free-Run	-
OUT	31–33	Relay1,2, Q1	30	Lost Keypad	-
DRV	06	Cmd Source	0	Keypad	-
CNF	22	Multi Key Sel	0	JOG Key	-

Speed Command Loss Setting Details

Code	Description										
PRT-11 Lost KPD Mode	Set the DRV-06 (command source) to "0 (keypad)", and select the inverter's operation for when there is a keypad connection problem.										
	<table border="1"> <thead> <tr> <th>Setting</th> <th>Function</th> </tr> </thead> <tbody> <tr> <td>0 None</td> <td>The speed command immediately becomes the operation frequency without any protection function.</td> </tr> <tr> <td>1 Warning</td> <td>Set one of the output terminals to "29 (Lost keypad)" to output a relevant warning signal when abnormal operating conditions arise.</td> </tr> <tr> <td>2 Free-Run</td> <td>The inverter blocks output when the keypad connection is lost. The motor performs in free-run condition.</td> </tr> <tr> <td>3 Dec</td> <td>The motor decelerates and then stops at the time set at PRT-07 (Trip Dec Time) when the keypad connection is lost.</td> </tr> </tbody> </table>	Setting	Function	0 None	The speed command immediately becomes the operation frequency without any protection function.	1 Warning	Set one of the output terminals to "29 (Lost keypad)" to output a relevant warning signal when abnormal operating conditions arise.	2 Free-Run	The inverter blocks output when the keypad connection is lost. The motor performs in free-run condition.	3 Dec	The motor decelerates and then stops at the time set at PRT-07 (Trip Dec Time) when the keypad connection is lost.
	Setting	Function									
	0 None	The speed command immediately becomes the operation frequency without any protection function.									
	1 Warning	Set one of the output terminals to "29 (Lost keypad)" to output a relevant warning signal when abnormal operating conditions arise.									
2 Free-Run	The inverter blocks output when the keypad connection is lost. The motor performs in free-run condition.										
3 Dec	The motor decelerates and then stops at the time set at PRT-07 (Trip Dec Time) when the keypad connection is lost.										
The protection function is also available for the keypad command loss during jog key operation when CNF-22 is set to "JOG Key."											

10.2.5 Speed Command Loss

When setting the operation speed using an analog input at the terminal block, communication options, or the keypad, the speed command loss setting can be used to select the inverter operation for situations when the speed command is lost due to the disconnection of signal cables. The function activates the command loss detection even for the operation command loss through communication.

Group	Code	LCD Display	Parameter Setting		Setting Range	Unit
PRT	12	Lost Cmd Mode	1	Free-Run	-	-
	13	Lost Cmd Time	-	1.0	0.0–120	Sec
	14	Lost Preset F	-	0.00	Starting Freq–Max. Freq	Hz
	15	AI Lost Level	1	Half of X1	-	-
OUT	31–33	Relay1,2, Q1	13	Lost Command	-	-

Speed Command Loss Setting Details

Code	Description	
PRT-12 Lost Cmd Mode	In situations when speed commands are lost, the inverter can be configured to operate in a specific mode:	
	Setting	Function
	0	None
	1	Free-Run
	2	Dec
	3	Hold Input
	4	Hold Output
5	Lost Preset	
PRT-15 AI Lost Level, PRT-13 Lost Cmd Time	Configure the voltage and decision time for speed command loss when using analog input.	
	Setting	Function
	0	Half of x1

Code	Description
	<p>the initial value of the analog input set using the speed command (DRV-01) and it continues for the time (speed loss decision time) set at PRT-13 (Lost Cmd Time). For example, set the speed command to "2 (V1)" at DRV-07, and set IN-06 (V1 Polarity) to "0 (Unipolar)". When the voltage input drops to less than half of the value set at IN-08 (V1 Volt x 1), the protective function is activated.</p>
1	<p>Below of x1</p> <p>The protective operation starts when the signal becomes smaller than the initial value of the analog input set by the speed command and it continues for the speed loss decision time set at PRT-13 (Lost Cmd Time). Codes IN-08 and IN-12 are used to set the standard values.</p>
PRT-14 Lost Preset F	<p>In situations where speed commands are lost, set the operation mode (PRT-12 Lost Cmd Mode) to "5 (Lost Preset)". This operates the protection function and sets the frequency so that the operation can continue.</p>

Set IN-06 (V1 Polarity) to "Unipolar" and IN-08 to "5 (V)". Set PRT-15 (AI Lost Level) to "1 (Below x1)" and PRT-12 (Lost Cmd Mode) to "2 (Dec)" and then set PRT-13 (Lost Cmd Time) to 5 seconds. Then the inverter operates as follows:

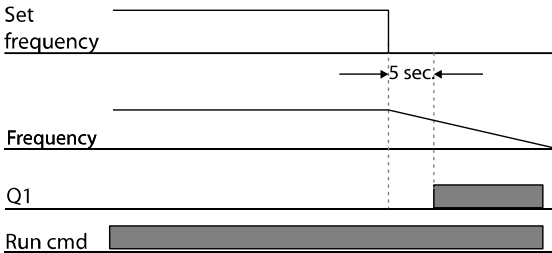

Note

If speed command is lost while using communication options or the integrated RS-485 communication, the protection function operates after the command loss decision time set at PRT-13 (Lost Cmd Time) is elapsed.

10.2.6 Dynamic Braking (DB) Resistor Configuration

The iS7 series is divided into a model which features a built-in braking circuit and the other in which a separate external braking unit should be installed. 0.75–22 kW model types belong to the former (braking resistor unit is excluded) and for those model types above 30 kW, you should install a

braking unit on the exterior of the inverter. Therefore the function of limiting the braking resistance use rate (%ED) is necessary for only models below 22 kW.

Group	Code	LCD Display	Parameter Setting	Setting Range	Unit
PRT	66	DB Warn %ED	- 10	0-30%	-
OUT	31-33	Relay1,2, Q1	31 DB Warn%ED	-	-

Dynamic Braking Resistor Setting Details

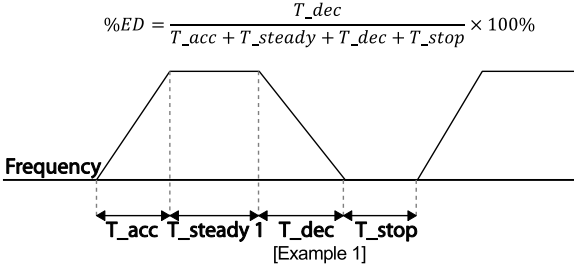
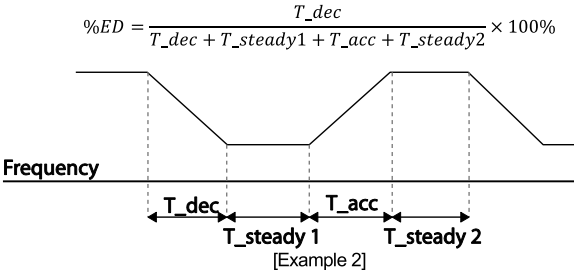
Code	Description
PRT-66 DB Warn %ED	<p>Sets braking resistor configuration (%ED: Duty cycle). Braking resistor configuration sets the rate at which the braking resistor operates for one operation cycle. The maximum time for continuous braking is 15 sec and the braking resistor signal is not output from the inverter after the 15 sec period has expired. An example of braking resistor set up is as follows:</p> $\%ED = \frac{T_{dec}}{T_{acc} + T_{steady} + T_{dec} + T_{stop}} \times 100\%$  <p>The graph shows a frequency profile with four phases: T_{acc} (ramp up), $T_{steady} 1$ (constant speed), T_{dec} (ramp down), and T_{stop} (zero speed). The duty cycle is defined as the ratio of deceleration time to the total cycle time.</p> $\%ED = \frac{T_{dec}}{T_{dec} + T_{steady}1 + T_{acc} + T_{steady}2} \times 100\%$  <p>The graph shows a frequency profile with four phases: T_{dec} (ramp down), $T_{steady} 1$ (constant speed), T_{acc} (ramp up), and $T_{steady} 2$ (constant speed). The duty cycle is defined as the ratio of deceleration time to the total cycle time.</p> <ul style="list-style-type: none"> • T_{acc}: Acceleration time to set frequency • T_{steady}: Constant speed operation time at set frequency • T_{dec}: Deceleration time to a frequency lower than constant speed

Code	Description
	operation or the stop time from constant speed operation frequency <ul style="list-style-type: none"> T_stop: Stop time until operation resumes

⚠ Caution

Do not set the braking resistor to exceed the resistor's power rating. If overloaded, it can overheat and cause a fire. When using a resistor with a heat sensor, the sensor output can be used as an external trip signal for the inverter's multi-function input.

10.2.7 Underload Warning and Failure

The following table lists the under load fault trip and warning features of the iS7 series inverter.

Group	Code	LCD Display	Parameter Setting		Setting Range	Unit
PRT	04	Load Duty	0	Normal Duty	-	-
	25	UL Warn Sel	1	Yes	0–1	
	26	UL Warn Time	-	10.0	0–600.0	sec
	27	UL Trip Sel	1	Free-Run	-	-
	28	UL Trip Time	-	30.0	0–600.0	sec
	29	UL LF Level	-	30	10–30	%
	30	UL BF Level	-	30	10–100	%

Under Load Trip and Warning Setting Details

Code	Description
PRT-27 UL Trip Sel	Sets the inverter operation mode for situations when an under load trip occurs. If "1 (Free-Run)" is set, the output is blocked in an under load fault trip situation. If "2 (Dec)" is set, the motor decelerates and stops when an under load trip occurs.
PRT-25 UL Warn Sel	Select the under load warning options. Set the multi-function output terminals (at OJT-30–32) to "6 (Underload)." The warning signals are output when an under load condition arises.
PRT-29 UL LF Level, PRT-30 UL BF Level	Sets the range necessary for underload detection based on the underload type. Set the underload rate at an operating frequency for the motor-rated slip speed (2x operation), (BAS-12 Rated Slip) at PRT-29. At PRT-30, the under load rate is decided based on the base frequency set at

Code	Description
	<p>DRV-18 (Base Freq). When variable torque is required (for example, for fans or pumps), set PRT-04 (Load Duty) to "0 (Normal Duty)." For loads operated at constant torques, like elevators and conveyors, set PRT-04 to "1 (Heavy Duty)."</p> <p>Output current</p> <p>Rated slipX2 Base frequency</p> <p>Set to normal load (Normal duty: VT)</p> <p>Output current</p> <p>Rated slipX2 Output frequency</p> <p>Set to heavy load (Heavy duty: CT)</p>
PRT-26 UL Warn Time, PRT-28 UL Trip Time	The protection function operates when the under load level condition explained above is maintained for the set warning time or fault trip time. This function does not operate if the energy-saving operation is activated at ADV-50 (E-SaveMode)

10.2.8 Overspeed Fault

This function is performed when the control mode (DRV-09 Control Mode) is set to "Sensorless-2", "Vector". If the motor rotates faster than the overspeed level (Over SPD Level) during the overspeed detection time (Over SPD Time), the inverter blocks output.

Group	Code	LCD Display	Parameter Setting		Unit
PRT	70	Over SPD Level	-	120.0	Hz
	72	Over SPD Time	-	0.01	Sec

10.2.9 Speed Deviation Fault

This function is performed when the control mode (DRV-09 Control Mode) is set to "Vector". If the motor rotates faster than the speed deviation limit (Speed Dev Band) for the set detection time (Speed Dev Time), the inverter will block output.

Group	Code	LCD Display	Parameter Setting		Unit
PRT	73	Speed Dev Trip	1	Yes	-
	74	Speed Dev Band	-	20.00	Hz
	75	Speed Dev Time	-	1.0	Sec

10.2.10 Speed Sensor (Encoder) Fault Detection

This function can detect whether the encoder expansion module is installed to the inverter. When the encoder is installed, if the encoder signal cable (line drive type) connection is lost, encoder-related faults are detected. If a fault occurs, a message reading "Encoder Trip" is displayed.

Group	Code	LCD Display	Parameter Setting		Unit
PRT	77	Enc Wire Check	1	Yes	-
	78	Enc Check Time	-	1.0	sec

10.2.11 Fan Fault Detection

Group	Code	LCD Display	Parameter Setting		Unit
PRT	79	FAN Trip Mode	0	Trip	-
OUT	31–32	Relay 1,2	8	FAN Warning	-
	33	Q1 Define			

Fan Fault Detection Setting Details

Code	Description						
PRT-79 Fan Trip Mode	Set the cooling fan fault mode.						
	<table border="1"> <thead> <tr> <th>Setting</th> <th>Function</th> </tr> </thead> <tbody> <tr> <td>0</td> <td>Trip</td> </tr> <tr> <td>1</td> <td>Warning</td> </tr> </tbody> </table>	Setting	Function	0	Trip	1	Warning
	Setting	Function					
0	Trip						
1	Warning						
The inverter output is blocked and the fan trip is displayed when a cooling fan error is detected.							
OUT-33 Q1 Define, OUT-31–32 Relay1, 2	When the code value is set to "8 (FAN Warning)", the fan error signal is output and operation continues. However, when the inverter's internal temperature rises above a certain level, output is blocked due to activation of overheat protection.						

10.2.12 Low Voltage Fault Trip

Group	Code	LCD Display	Parameter Setting		Unit
PRT	81	LVT Delay	-	0.0	sec
OUT	31–32	Relay 1,2	11	Low Voltage	-
	33	Q1 Define			

Low Voltage Fault Trip Setting Details

Code	Description
PRT-81 LVT Delay	When inverter input power is lost and the internal DC link voltage drops below a certain voltage level, the inverter will block the output and a low voltage trip will occur. If the PRT-81 LVT Delay time is set, the inverter blocks output first when a low voltage trip condition arises, then a fault trip will occur after the low voltage trip decision time has passed. The warning signal for a low voltage fault trip can be provided using the multi-function output or a relay. However, the low voltage trip delay time (LVT Delay time) does not apply to warning signals.

Code	Description
OUT-33 Q1 Define, OUT-31–32 Relay1, 2	Set to "11 (Low Voltage)". The inverter stops the output first when a low voltage trip condition occurs, then a fault trip occurs after the low voltage trip decision time elapses.

10.2.13 Output Block via the Multi-Function Terminal

Group	Code	LCD Display	Parameter Setting		Setting Range	Unit
IN	65–72	Px Define	5	BX	-	-
PRT	45	BX Mode	-	0.0	0.0–600.0	

Output Block by Multi-function Terminal Setting Details

Code	Description
IN-65–71 Px Define	When the operation of the multi-function input terminal is set to "5 (BX)" and is turned on during operation, the inverter blocks the output and "BX" is displayed on the keypad display. While "BX" is displayed on the keypad, the inverter's operation information including the operation frequency and current at the time of the BX signal can be monitored. The inverter resumes operation when the BX terminal turns off and operation command is input.
PRT-45	<p>The default setting value of BX mode (PRT-45) is 0.0 [sec], and it allows the inverter to operate in free-run mode. If the BX terminal receives input, the inverter will block output immediately.</p> <p>If BX mode (PRT-45) is set to 0.1 [sec], the motor will decelerate by value set at PRT-45.</p> <p>If PRT-45 set value is too small, the inverter cannot decelerate at that value and OVT may occur. Set the PRT45 time according to the inverter capacity and load.</p>

10.2.14 Trip Status Reset

Group	Code	LCD Display	Parameter Setting		Unit
IN	65-72	Px Define	3	RST	-

Trip Status Reset Setting Details

Code	Description
IN-65–72 Px Define	Press the [Stop/Reset] key on the keypad or use the multi-function input terminal to restart the inverter. Set the multi-function input terminal to “3 (RST)” and turn on the terminal to reset the trip status.

10.2.15 Operation Mode On Optional Expansion Module Fault Trip

Optional extension module trips may occur when an optional extension module is used with the inverter. Set the operation mode for the inverter when a communication error occurs between the optional extension module and the inverter body, or when the optional extension module is detached during operation.

Group	Code	LCD Display	Parameter Setting		Unit
PRT	80	Opt Trip Mode	0	None	1:Free-Run
			1	Free-Run	
			2	Dec	

Optional Expansion Module Fault Trip Setting Details

Code	Description		
PRT-80 Opt Trip Mode	Setting		Function
	0	None	No operation
	1	Free-Run	The inverter output is blocked and fault trip information is shown on the keypad.
	2	Dec	The motor decelerates to the value set at PRT-07 (Trip Dec Time).

10.2.16 No Motor Trip

Group	Code No.	LCD Display	Parameter Setting		Setting Range	Unit
PRT	31	No Motor Trip	0	None	-	-
	32	No Motor Level		5	1–100	%
	33	No Motor Time		3.0	0.1–10.0	sec

No Motor Trip Setting Details

Code	Description
PRT-32 No Motor Level, PRT-33 No Motor Time	If the output current value [based on the rated current (BAS-13)] is lower than the value set at PRT-32 (No Motor Level), and if this continues for the time set at PRT-33 (No Motor Time), a "no motor trip" occurs.

⚠ Caution

If BAS-07 (V/F Pattern) is set to "1 (Square)", set PRT-32 (No Motor Level) to a value lower than the factory default. Otherwise, "No Motor Trip" due to a lack of output current will result when the 'No Motor Trip' operation is set.

10.2.17 Low Voltage Fault Trip 2 During Operation

Group	Code	LCD Display	Parameter Setting range		Unit
PRT	82	Low Voltage2	00~11	00 : default	Bit













If input power is disconnected during inverter operation and internal DC voltage decreases lower than a certain voltage, the inverter disconnects the output and displays low voltage "2" on the keypad.

Even if the voltage increases and goes back to the normal state, unlike a low voltage fault, it remains in a fault state until the user unlocks the fault state.

If PRT-82 (LV2 Enable) is set to "01," and if the input power is disconnected during inverter operation and the internal DC voltage drops to lower than a certain voltage, the inverter stops output and displays "Low Voltage2." Unlike the low voltage trip (Low Voltage), the low voltage 2 (Low Voltage2) trip will not be reset even after the internal DC voltage of the inverter has recovered to above the trip level. Therefore, you must reset the inverter to reset the trip. The trip history will not be stored after the reset.

Set PRT-82 (LV2 Enable) to "11" to store the trip history.

Low Voltage 2 Trip Details

Code	Description										
PRT-82	Set options for Low Voltage2 trip operation.										
	<table border="1" style="width: 100%;"> <thead> <tr> <th data-bbox="321 357 480 378">Bit setting</th> <th data-bbox="480 357 966 378">Function</th> </tr> </thead> <tbody> <tr> <td data-bbox="321 378 480 437" style="text-align: center;"></td> <td data-bbox="480 378 966 437">Disable Low Voltage2 trip (Low Voltage trip is used).</td> </tr> <tr> <td data-bbox="321 437 480 507" style="text-align: center;"></td> <td data-bbox="480 437 966 507">Enable Low Voltage2 trip. but do not store the trip history.</td> </tr> <tr> <td data-bbox="321 507 480 568" style="text-align: center;"></td> <td data-bbox="480 507 966 568">Disable Low Voltage2 trip (Low Voltage trip is used).</td> </tr> <tr> <td data-bbox="321 568 480 628" style="text-align: center;"></td> <td data-bbox="480 568 966 628">Enable Low Voltage2 trip and store the trip history.</td> </tr> </tbody> </table>	Bit setting	Function		Disable Low Voltage2 trip (Low Voltage trip is used).		Enable Low Voltage2 trip. but do not store the trip history.		Disable Low Voltage2 trip (Low Voltage trip is used).		Enable Low Voltage2 trip and store the trip history.
	Bit setting	Function									
		Disable Low Voltage2 trip (Low Voltage trip is used).									
		Enable Low Voltage2 trip. but do not store the trip history.									
	Disable Low Voltage2 trip (Low Voltage trip is used).										
	Enable Low Voltage2 trip and store the trip history.										

10.3 List of Faults and Warnings

The following list shows the types of faults and warnings that can occur while using the iS7 inverter.

Category		LCD Display	Details
Major fault	Latch type	Over Current1	Over current trip
		Over Voltage	Over voltage trip
		External Trip	Trip due to an external signal
		NTC Open	Temperature sensor fault trip
		Over Current2	ARM short current fault trip
		Fuse Open	Fuse open trip
		Option Trip-x	Option fault trip
		Over Heat	Over heat fault trip
		Out Phase Open	Output open-phase fault trip
		In Phase Open	Input open-phase fault trip
		Inverter OLT	Inverter overload fault trip
		Over Speed	Over speed fault trip
		Ground Trip	Ground fault trip
		Encoder Trip	Speed sensor fault trip
Fan Trip	Fan fault trip		

Using Protection Features

Category		LCD Display	Details
Minor fault	Level type	ParaWrite Trip	Write parameter fault trip
		E-Thermal	Motor overheat fault trip
		Thermal Trip	Temperature fault trip
		Pre-PID Fail	Pre-PID operation fault trip
		IO Board Trip	IO Board connection fault trip
		Speed Dev Trip	Trip from speed deviation
		Ext-Brake	External brake fault trip
		No Motor Trip	No motor fault trip
		Low Voltage	Low voltage fault trip
		BX	Emergency stop fault trip
		Lost Command	Command loss trip
		Lost Keypad	Lost-keypad fault trip
	Hardware damage	EEP Err	External memory error
		ADC Off Set	Analog input error
		Watch Dog-1	CPU Watch Dog fault trip
		Watch Dog-2	
		Gate Pwr Loss	DRV operation power error
		Over Load	Motor overload trip
		Under Load	Motor under load trip
		Lost Command	Lost command fault trip
Lost Keypad	Lost keypad fault trip		
Warning	Lost Command	Command loss fault trip warning	
	Over Load	Overload warning	
	Under Load	Under load warning	
	Inverter OLT	Inverter overload warning	
	Fan Warning	Fan operation warning	
	DB Warn %ED	Braking resistor braking rate warning	
	Enc Conn Check	Enc connection error warning	
	Enc Dir Check	Rotating direction error warning	
	Lost Keypad	Lost keypad warning	
	Retry Tr Tune	Rotor time constant tuning error	

Category	LCD Display	Details
	Fire Mode	Fire mode warning
	PID Sleep	PID Sleep mode warning
	AUX Power On	AUX Power On warning

11 Communication Function

11.1 Introduction

This chapter explains the standards, installation process, and programs for the SV-iS7 inverter serial communication method when using personal computers or factory automation (FA) computers. The communication function for the SV-iS7 inverter series is designed to remotely operate or monitor the SV-iS7 inverter series using personal computers or FA computers.

Advantages of Operating the Inverter with Network Communication

As the inverter can be operated or monitored by the user programs, it is easy to apply the inverter to factory automation.

Features	Examples of application
Monitor or modify parameters via computers	<ul style="list-style-type: none"> • T_acc • T_dec • Frequency • Lost command
Interface configuration for RS-485 standard	<ul style="list-style-type: none"> • Performs communication between the inverter and computers produced by numerous companies. • Controls up to 16 inverters at a time with one computer using the multi-drop link system. • Provides an interface for noise immunity environments.

Inverters can communicate with computers embedded with the RS-232 module via RS-232/485 converters. The standards and performance of converters may vary depending on the manufacturer, but the basic functions are the same. For more details about standards and guidelines, users are advised to consult the manual provided by the specific manufacturer.

Caution

Read this manual carefully before installation and operation. All instructions in this manual must be followed to avoid injury or prevent damage to other components.

11.2 Specifications

Category	Specifications
Communication method	RS-485
Transfer form	Bus type, Multi-drop link system
Inverter type name	SV-IS7 series
Converter	Embedded with RS-232
Number of connected inverters	Maximum of 16
Transfer distance	Maximum 1,200 m (recommended distance: within 700 m)
Recommended cable size	0.75 mm ² , (18AWG), Shielded twisted-pair (STP) wire
Installation type	Dedicated terminals (S+/S-/SG) on the control terminal block
Communication Power	Supplied by the inverter - insulated power source from the inverter's internal circuit communication power (supplied from the inverter)
Communication Speed	1,200/2,400/9,600/19,200/38,400 bps
Control procedure	Asynchronous communications system
Communication system	Half duplex system
Letter system	Modbus-RTU: BINARY/LS Bus: ASCII
Stop bit length	1-bit/2-bit
Sum check	2 byte
Parity check	None/Even/Odd

11.3 Communication System Configuration

In an RS-485 communication system, the PLC or computer is the master device and the inverter is the slave device. When using a computer as the master, the RS-232 converter must be integrated with the computer, so that it can communicate with the inverter through the RS-232/RS-485 converter. Specifications and performance of converters may vary depending on the manufacturer, but the basic functions are identical. Please refer to the converter manufacturer's user manual for details about features and specifications.

Connect the wires and configure the communication parameters on the inverter by referring to the following illustration of the communication system configuration.

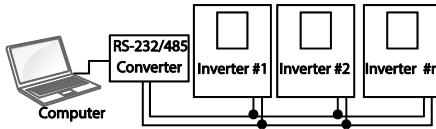

- RS-485 terminal connection: Connect the RS-485 communication line to the S+/S-/SG terminals.
- Number of connectable inverters: Up to 16 inverters
- Number of extendable addresses (St ID): 1–250 addresses
- Length of effective communication lines: 1,200 m max. Keep it below 700 m for stable communication.

⚠ Caution

When wiring the communication line, make sure that the SG terminals on the PLC and inverter are connected. SG terminals prevent communication errors due to electronic noise interference.

Use a communication repeater to enhance the communication speed if you have to use a communication cable above 1,200 m, or to connect an additional inverter. A repeater is effective when smooth communication is not available due to noise interference.

11.4 Basic Settings

Before proceeding with setting communication configurations, make sure that the communication lines are connected properly. Turn on the inverter and set the communication parameters.

Group	Code	LCD Display	Parameter Setting		Setting Range	Unit
COM	01	Int485 St ID	-	1	1-250	-
	02	Int485 Proto	0	ModBus RTU	0-3	-
	03	Int485 BaudR	3	9600	0-5	bps
	04	Int485 Mode	0	D8 / PN / S1	0-3	-
	05	Resp Delay	-	5	0-1000	ms

Communication Parameters Setting Details

Code	Description										
COM-01 Int485 St ID	Sets the inverter station ID between 1 and 250.										
COM-02 Int485 Proto	Select one of the two built-in protocols: Modbus-RTU and LS INV 485										
	<table border="1"> <thead> <tr> <th>Setting</th> <th>Function</th> </tr> </thead> <tbody> <tr> <td>0</td> <td>Modbus-RTU</td> </tr> <tr> <td>1</td> <td>Reserved</td> </tr> <tr> <td>2</td> <td>LS INV 485</td> </tr> </tbody> </table>	Setting	Function	0	Modbus-RTU	1	Reserved	2	LS INV 485		
	Setting	Function									
	0	Modbus-RTU									
1	Reserved										
2	LS INV 485										
0	Modbus-RTU compatible protocol										
1	Not used										
2	Dedicated protocol for the LS inverter										
COM-03 Int485 BaudR	Sets a communication setting speed of up to 38,400 bps.										
COM-04 Int485 Mode	Set a communication configuration. Set the data length, parity check method, and the number of stop bits.										
	<table border="1"> <thead> <tr> <th>Setting</th> <th>Function</th> </tr> </thead> <tbody> <tr> <td>0</td> <td>D8/PN/S1</td> </tr> <tr> <td>1</td> <td>D8/PN/S2</td> </tr> <tr> <td>2</td> <td>D8/PE/S1</td> </tr> <tr> <td>3</td> <td>D8/PO/S1</td> </tr> </tbody> </table>	Setting	Function	0	D8/PN/S1	1	D8/PN/S2	2	D8/PE/S1	3	D8/PO/S1
	Setting	Function									
	0	D8/PN/S1									
	1	D8/PN/S2									
2	D8/PE/S1										
3	D8/PO/S1										
0	8-bit data / no parity check / 1 stop bit										
1	8-bit data / no parity check / 2 stop bits										
2	8-bit data / even parity / 1 stop bit										
3	8-bit data / odd parity / 1 stop bit										
COM-05 Resp Delay	The built-in 485 communication (Modbus-RTU or LS INV 485) device performs as a slave. The slave iS7 responds to the master after the period of time set in this function code.										

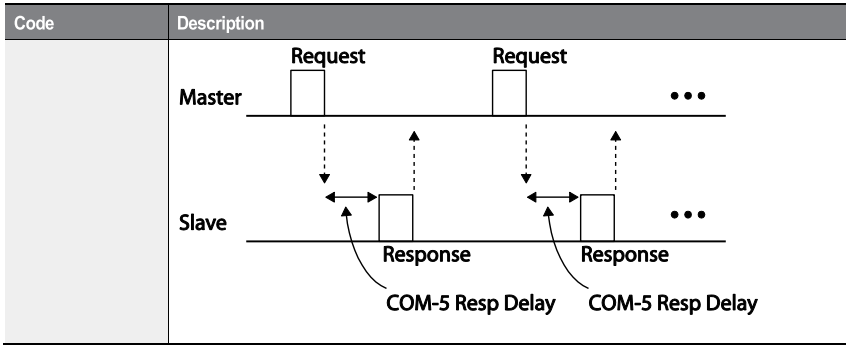

11.5 Setting Operation Command and Frequency

After setting the DRV-06 (Cmd Source) to “3 (Int 485)” and DRV-07 (Freq Ref Src) to “7 (Int 485),” you can set common area parameters for the operation command and frequency via communication.

Group	Code	LCD Display	Parameter Setting		Unit
DRV	06	Cmd Source	3	Int 485	-
	07	Freq Ref Src	7	Int 485	-

11.6 Command Loss Protection

Configure the command loss decision standards and protective operations run when a communication problem lasts for a specified period of time.

Group	Code	LCD Display	Parameter Setting		Unit
PRT	12	Lost Cmd Mode	1	Free-Run	-
	13	Lost Cmd Time	-	1.0	Sec
	14	Lost Preset F	-	0.00	Hz
OUT	31–33	Relay1,2, Q1	12	Lost Command	-

Command Loss Protective Operation Setting Details

Code	Description																				
PRT-12 Lost Cmd Mode, PRT-13 Lost Cmd Time	Select the operation to run when a communication error has occurred and lasted exceeding the time set at PRT-13.																				
	<table border="1"> <thead> <tr> <th>Setting</th> <th>Function</th> </tr> </thead> <tbody> <tr> <td>0</td> <td>None</td> <td>The speed command immediately becomes the operation frequency without any protection function.</td> </tr> <tr> <td>1</td> <td>Free-Run</td> <td>The inverter blocks output. The motor performs in free-run condition.</td> </tr> <tr> <td>2</td> <td>Dec</td> <td>The motor decelerates and then stops.</td> </tr> <tr> <td>3</td> <td>Hold Input</td> <td>Operates continuously with the speed of the inputted speed command until the loss of the speed command. The inverter calculates the average input value for 10 seconds before the loss of the speed command and uses it as the speed reference.</td> </tr> <tr> <td>4</td> <td>Hold Output</td> <td>Operates continuously with the operate frequency before the speed loss. The inverter calculates the average output value for 10 seconds before the loss of the speed command and uses it as the speed reference.</td> </tr> <tr> <td>5</td> <td>Lost Preset</td> <td>The inverter operates at the frequency set at PRT-14 (Lost Preset F).</td> </tr> </tbody> </table>	Setting	Function	0	None	The speed command immediately becomes the operation frequency without any protection function.	1	Free-Run	The inverter blocks output. The motor performs in free-run condition.	2	Dec	The motor decelerates and then stops.	3	Hold Input	Operates continuously with the speed of the inputted speed command until the loss of the speed command. The inverter calculates the average input value for 10 seconds before the loss of the speed command and uses it as the speed reference.	4	Hold Output	Operates continuously with the operate frequency before the speed loss. The inverter calculates the average output value for 10 seconds before the loss of the speed command and uses it as the speed reference.	5	Lost Preset	The inverter operates at the frequency set at PRT-14 (Lost Preset F).
	Setting	Function																			
	0	None	The speed command immediately becomes the operation frequency without any protection function.																		
	1	Free-Run	The inverter blocks output. The motor performs in free-run condition.																		
	2	Dec	The motor decelerates and then stops.																		
3	Hold Input	Operates continuously with the speed of the inputted speed command until the loss of the speed command. The inverter calculates the average input value for 10 seconds before the loss of the speed command and uses it as the speed reference.																			
4	Hold Output	Operates continuously with the operate frequency before the speed loss. The inverter calculates the average output value for 10 seconds before the loss of the speed command and uses it as the speed reference.																			
5	Lost Preset	The inverter operates at the frequency set at PRT-14 (Lost Preset F).																			
PRT-14 Lost Preset F	Set the Lost Preset frequency that will be applied if PRT-12 (Lost Cmd Mode) is set to "5 (Lost Preset)."																				

Caution) If PRT-13 (Lost Cmd Time) is set to "0.0" (sec), protection features may be activated even during a normal operation, depending on the type of command source. To prevent this, appropriately set the lost command decision time.

11.7 Setting Virtual Multi-Function inputs

Multi-function input can be controlled using a communication address (0h0385). Set codes COM-70–85 to the functions to operate, and then set the BIT relevant to the function to 1 at 0h0385 to operate it.

Group	Code	LCD Display	Parameter Setting		Unit
COM	70-85	Virtual DI x	0	None	-
	86	Virt DI Status	-	-	-

For example, if you want to send an Fx command by controlling a virtual multi-function input command addresses with Int485, the Fx function is performed if 0h0001 is input in 0h0385 after COM-70 (Virtual DI 1) is set to "FX". Before you configure the virtual multi-function inputs, set the DRV-06 (CMD source) depending on the command source.

Virtual multi-function operates independently from the analog multi-function inputs and cannot be set redundantly. Virtual multi-function input can be monitored using COM-86 (Virt DI Status).

11.8 Saving Parameters Defined by Communication

If you turn off the inverter after setting the common area parameters or keypad parameters via communication and operate the inverter, the changes are lost and the values changed via communication revert to the previous setting values when you turn on the inverter.

Set CNF-48 to “1 (Yes)” to allow all the changes over communication to be saved, so that the inverter retains all the existing values even after the power has been turned off.

Setting address 0h03E0 to “0” and then setting it again to “1” via communication allows the existing parameter settings to be saved. However, setting address 0h03E0 to “1” and then setting it to “0” does not carry out the same function.

Before reading the parameters utilizing CNF-46 (Parameter Read), make sure to save the parameter changes (Parameter Save) to read the parameter values reflecting the changes in the communication module parameters.

Group	Code	LCD Display	Setting Display		Unit
CNF	48	Parameter Save	0	-No-	-
			1	-Yes-	-

11.9 Communication Frame Monitoring

You can easily monitor the status (normal, CRC/Checksum error, other errors, etc.) of the communication frame being received from the master by using the keypad.

Group	Code	LCD Display	Setting Display		Unit
COM	90	Comm Mon Sel	0	Int 485	-
	91	Rcv Frame Num	-	-	-
	92	Err Frame Num	-	-	-
	93	NAK Frame Num	-	-	-
	94	Comm Update	0	-No-	-
		1	-Yes-		

Communication Frame Monitoring Details

Code	Description
COM-90 Comm Mon Sel	Selects the communication channel to monitor.
COM-91 Rcv Frame Num	Counts the number of communication frames received normally from the master device.
COM-92 Err Frame Num	Counts the number of CRC errors when the Modbus-RTU is set and counts Checksum errors when the LS Inv 485 is set.
COM-93 NAK Frame Num	Counts the number of errors (communication address errors, data range errors, writing prohibition errors) that occur in the communication frames received from the master device.
COM-94 Comm Update	Reconnects the communication after the initial status parameter is changed to communication speed (baud rate), etc.

11.10 Special communication Area Settings

The following table lists the memory map of the entire memory addresses used for network communication in the iS7 series inverters.

Communication Area	Memory Map	Description
Common iS5 compatible communication area	0h0000 - 0h00FF	Area compatible with iS5
Parameter registration type area	0h0100 - 0h01FF	Area registered in COM31~46, COM51~66

Communication Area	Memory Map	Description
	0h0200 - 0h023F	Area registered in User Group
	0h0240 - 0h027F	Area registered in Macro Group
	0h0280 - 0h02FF	Reserved
Common iS7 communication area	0h0300 - 0h037F	Inverter monitoring area
	0h0380 - 0h03DF	Inverter control area
	0h03E0 - 0h03FF	Inverter memory control area
	0h0400 - 0h0FFF	Reserved
	0h1100	DRV Grp
	0h1200	BAS Grp
	0h1300	ADV Grp
	0h1400	CON Grp
	0h1500	IN Grp
	0h1600	OUT Grp
	0h1700	COM Grp
	0h1800	APP Grp
	0h1A00	APO Grp
	0h1B00	PRT Grp
	0h1C00	M2 Grp

11.11 Parameter Group for Periodical Data Transmission

By defining a parameter group for data transmission, the communication addresses registered in the communication function group (CM) can be used in communication. Parameter groups for data transmission may be defined to simultaneously transmit multiple parameters into the communication frame.

Group	Code No.	Function Display	Setting Display		Unit
COM	31-46	Para Status-h	-	-	Hex
	51-66	Para Control-h	-	-	Hex

Parameter Group for Periodical Data Transmission Details

Addresses	Description		
0h0100~0h010F	Reads the parameter registered in COM-31~46 Status Para-h (read only).		
	Address	Parameter	Allotment for Bits
	0h0100	Status Parameter #1	Parameter value registered at COM-31
	0h0101	Status Parameter #2	Parameter value registered at COM-32
	0h0102	Status Parameter #3	Parameter value registered at COM-33
	0h0103	Status Parameter #4	Parameter value registered at COM-34
	0h0104	Status Parameter #5	Parameter value registered at COM-35
	0h0105	Status Parameter #6	Parameter value registered at COM-36
	0h0106	Status Parameter #7	Parameter value registered at COM-37
	0h0107	Status Parameter #8	Parameter value registered at COM-38
	0h0108	Status Parameter #9	Parameter value registered at COM-39
	0h0109	Status Parameter #10	Parameter value registered at COM-40
	0h010A	Status Parameter #11	Parameter value registered at COM-41
	0h010B	Status Parameter #12	Parameter value registered at COM-42
	0h010C	Status Parameter #13	Parameter value registered at COM-43
	0h010D	Status Parameter #14	Parameter value registered at COM-44
	0h010E	Status Parameter #15	Parameter value registered at COM-45
0h010F	Status Parameter #16	Parameter value registered at COM-46	
0h0110~0h011F	Reads and writes the parameter registered in COM-51~66 Control Para-h (both read and write).		
	Address	Parameter	Allotment for Bits
	0h0110	Control Parameter #1	Parameter value registered at COM-51
	0h0111	Control Parameter #2	Parameter value registered at COM-52
	0h0112	Control Parameter #3	Parameter value registered at COM-53
	0h0113	Control Parameter #4	Parameter value registered at COM-54
	0h0114	Control Parameter #5	Parameter value registered at COM-55
	0h0115	Control Parameter #6	Parameter value registered at COM-56
	0h0116	Control Parameter #7	Parameter value registered at COM-57
	0h0117	Control Parameter #8	Parameter value registered at COM-58
	0h0118	Control Parameter #9	Parameter value registered at COM-59
	0h0119	Control Parameter #10	Parameter value registered at COM-60
	0h011A	Control Parameter #11	Parameter value registered at COM-61
	0h011B	Control Parameter #12	Parameter value registered at COM-62
	0h011C	Control Parameter #13	Parameter value registered at COM-63
	0h011D	Control Parameter #14	Parameter value registered at COM-64
	0h011E	Control Parameter #15	Parameter value registered at COM-65
0h011F	Control Parameter #16	Parameter value registered at COM-66	

⚠ Caution

When registering control parameters, register the operation speed (0h0005, 0h0380, 0h0381) and operation command (0h0006, 0h0382) parameters at the end of a parameter control frame. For example, when the parameter control frame has 5 parameter control items (Para Control - x), register the operation speed at Para Control-4 and the operation command to Para Control-5.

11.12 Parameter Group for Transmission of Macro Group and User Group at U&M Mode

By defining the user and macro parameter groups, communication can be carried out using the user defined user group (USR) and macro group (MAC) addresses that are registered in U&M mode.

Addresses	Description		
U&M>USR-1~64 User Grp. Para h	Writes and reads the USR parameters set by the keypad via the addresses 0h0200~0h023F.		
	Address	Parameter	Allotment for Bits
	0h0200	User Grp. Code 1	Parameter value registered at U&M>USR->1
	0h0201	User Grp. Code 2	Parameter value registered at U&M>USR->2

	0h023E	User Grp. Code 63	Parameter value registered at U&M>USR->63
0h023F	User Grp. Code 64	Parameter value registered at U&M>USR->64	
U&M>MAC-1~64 Macro Grp. Para h	Writes and reads the Macro parameters set by the keypad via the addresses 0h2400~0h2A3.		
	Address	Parameter	Allotment for Bits
	0h0240	Macro Grp. Code 1	Parameter value registered at U&M>MAC-1
	0h0241	Macro Grp. Code 2	Parameter value registered at U&M>MAC-2

	0h02A2	Macro Grp. Code 63	Parameter value registered at U&M>MAC-63
0h02A3	Macro Grp. Code 64	Parameter value registered at U&M>MAC-64	

11.13 Communication Protocol

11.13.1 LS INV 485 Protocol

The slave device (inverter) responds to read and write requests from the master device (PLC or PC).

Request

ENQ	Station ID	CMD	Data	SUM	EOT
1 byte	2 bytes	1 byte	n bytes	2 bytes	1 byte

Normal Response

ACK	Station ID	CMD	Data	SUM	EOT
1 byte	2 bytes	1 byte	n x 4 bytes	2 bytes	1 byte

Error Response

NAK	Station ID	CMD	Error code	SUM	EOT
1 byte	2 bytes	1 byte	2 bytes	2 bytes	1 byte

- A request starts with ENQ and ends with EOT.
- A normal response starts with ACK and ends with EOT.
- An error response starts with NAK and ends with EOT.
- A station ID indicates the inverter number and is displayed as a two-byte ASCII-HEX string that uses characters 0-9 and A-F.
- CMD: Uses uppercase characters (returns an IF error if lowercase characters are encountered).

Character	ASCII-HEX	Command
'R'	52h	Read
'W'	57h	Write
'X'	58h	Request monitor registration
'Y'	59h	Perform monitor registration

- Data: ASCII-HEX (for example, when the data value is 3000: 3000 → '0"B"B"8'h → 30h 42h 42h 38h)
- Error code: ASCII-HEX (20h–7Fh)
- Transmission/reception buffer size: Transmission=39 bytes, Reception=44 bytes
- Monitor registration buffer: 8 Words
- SUM: Checks communication errors via sum.
- SUM=a total of the lower 8 bits values for station ID, command and data (Station ID+CMD+Data) in ASCII-HEX.
- For example, a command to read 1 address from address 3000:
SUM='0'+1+'R'+3+'0'+0+'0'+0+'1' = 30h+31h+52h+33h+30h+30h+30h+31h = 1A7h (the control value is not included: ENQ, ACK, NAK, etc.

ENQ	Station ID	CMD	Address	Number of Addresses	SUM	EOT
05h	'01'	'R'	'3000'	'1'	'A7'	04h
1 byte	2 bytes	1 byte	4 bytes	1 byte	2 bytes	1 byte

Note

Broadcasting

Broadcasting sends commands to all inverters connected to the network simultaneously. When commands are sent from station ID 255, each inverter acts on the command regardless of the station ID. However no response is issued for commands transmitted by broadcasting.

Error operation

For two or more data communications, when an error occurs as a result of the previous data communication, the current data communication can be made normally regardless of the error occurred as a result of the previous data communication.

11.13.1.1 Detailed Read Protocol

Read Request

Reads successive n words from address XXXX.

ENQ	Station ID	CMD	Address	Number of Addresses	SUM	EOT
05h	'01'-'1F'	'R'	'XXXX'	'1'-'8' = n	'XX'	04h
1 byte	2 bytes	1 byte	4 bytes	1 byte	2 bytes	1 byte

Total bytes=12. Characters are displayed inside single quotation marks(').

Read Normal Response

ACK	Station ID	CMD	Data	SUM	EOT
06h	'01'-'1F'	'R'	'XXXX'	'XX'	04h
1 byte	2 bytes	1 byte	n x 4 bytes	2 bytes	1 byte

Total bytes= (7 x n x 4): a maximum of 39

Read Error Response

NAK	Station ID	CMD	Error code	SUM	EOT
15h	'01'-'1F'	'R'	***	'XX'	04h

NAK	Station ID	CMD	Error code	SUM	EOT
1 byte	2 bytes	1 byte	2 bytes	2 bytes	1 byte

Total bytes=9

11.13.12 Detailed Write Protocol

Write Request

ENQ	Station ID	CMD	Address	Number of Addresses	Data	SUM	EOT
05h	'01'-'1F'	'W'	'XXXX'	'1'-'8' = n	'XXXX...'	'XX'	04h
1 byte	2 bytes	1 byte	4 bytes	1 byte	n x 4 bytes	2 bytes	1 byte

Total bytes= (12 + n x 4): a maximum of 44

Write Normal Response

ACK	Station ID	CMD	Data	SUM	EOT
06h	'01'-'1F'	'W'	'XXXX...'	'XX'	04h
1 byte	2 bytes	1 byte	n x 4 bytes	2 bytes	1 byte

Total bytes= (7 + n x 4): a maximum of 39

Write Error Response

NAK	Station ID	CMD	Error Code	SUM	EOT
15h	'01'-'1F'	'W'	***	'XX'	04h
1 byte	2 bytes	1 byte	2 bytes	2 bytes	1 byte

Total bytes=9

11.13.1.3 Monitor Registration Detailed Protocol

Monitor registration request is made to designate the type of data that requires continuous monitoring and periodic updating.

Monitor Registration Request

Registration requests for n addresses (where n refers to the number of addresses. The addresses do not have to be contiguous.)

ENQ	Station ID	CMD	Number of Addresses	Address	SUM	EOT
05h	'01'-'1F'	'X'	'1'-'8'=n	'XXX...'	'XX'	04h
1 byte	2 bytes	1 byte	1 byte	n x 4 bytes	2 bytes	1 byte

Total bytes= (8 + n x 4): a maximum of 40

Monitor Registration Normal Response

ACK	Station ID	CMD	SUM	EOT
06h	'01'-'1F'	'X'	'XX'	04h
1 byte	2 bytes	1 byte	2 bytes	1 byte

Total bytes=7

Monitor Registration Error Response

NAK	Station ID	CMD	Error Code	SUM	EOT
15h	'01'-'1F'	'X'	'**'	'XX'	04h
1 byte	2 bytes	1 byte	2 bytes	2 bytes	1 byte

Total bytes=9

11.13.1.4 Monitor Execution Detailed Protocol

Monitor Registration Execution Request

A data read request for a registered address, received from a monitor registration request

ENQ	Station ID	CMD	SUM	EOT
05h	'01'-'1F'	'Y'	'XX'	04h

ENQ	Station ID	CMD	SUM	EOT
1 byte	2 bytes	1 byte	2 bytes	1 byte

Total bytes=7

Monitor Registration Execution Normal Response

ACK	Station ID	CMD	Data	SUM	EOT
06h	'01'-'1F'	'Y'	'XXXX...'	'XX'	04h
1 byte	2 bytes	1 byte	n x 4 bytes	2 bytes	1 byte

Total bytes= (7 + n x 4): a maximum of 39

Monitor Registration Execution Error Response

NAK	Station ID	CMD	Error Code	SUM	EOT
15h	'01'-'1F'	'Y'	***	'XX'	04h
1 byte	2 bytes	1 byte	2 bytes	2 bytes	1 byte

Total bytes=9

11.13.1.5 Error Code

Code	Abbreviation	Description
01: ILLEGAL FUNCTION	IF	The requested function cannot be performed by a slave because the corresponding function does not exist.
02: ILLEGAL DATA ADDRESS	IA	The received parameter address is invalid at the slave.
03: ILLEGAL DATA VALUE	ID	The received parameter data is invalid at the slave.
21: WRITE MODE ERROR	WM	Tried writing (W) to a parameter that does not allow writing (read-only parameters, or when writing is prohibited during operation)
22: FRAME ERROR	FE	The frame size does not match.

11.13.2 Modbus-RTU protocol

11.13.2.1 Function Code and Protocol (unit: byte)

Function Code #03 (Read Holding Register)

<Query>	<Response>
Field Name	Field Name
Slave Address	Slave Address
Function	Function
Starting Address Hi	Byte Count
Starting Address Lo	Data Hi (Register 40108)
# of Points Hi	Data Lo (Register 40108)
# of Points Lo	Data Hi (Register 40109)
CRC Lo	Data Lo (Register 40109)
CRC Hi	Data Hi (Register 40110)
	Data Lo (Register 40110)
	CRC Lo
	CRC Hi

Function Code #04 (Read Input Register)

<Query>	<Response>
Field Name	Field Name
Slave Address	Slave Address
Function	Function
Starting Address Hi	Byte Count
Starting Address Lo	Data Hi (Register 30009)
# of Points Hi	Data Lo (Register 30009)
# of Points Lo	CRC Lo
CRC Lo	CRC Hi
CRC Hi	

Communication Function

Field Name

Function*

Exception Code

CRC Lo

CRC Hi

* Function value is the set value of the highest bit of the query function value.

11.13.3 iS7/iS5/iG5/iG5A Compatible Common Area Parameter

Address	Parameter	Scale	Unit	R/W	Assigned content by bit
0h0000	Inverter model	-	-	R	B: iS7
0h0001	Inverter capacity	-	-	R	0: 0.75 kW 1: 1.5 kW 2: 2.2 kW 3: 3.7 kW 4: 5.5 kW 5: 7.5 kW 6: 11 kW 7: 15 kW 8: 18.5 kW 9: 22 kW 10: 30 kW 11: 37 kW 12: 45 kW 13: 55 kW 14: 75 kW 15: 90 kW 16: 110 kW 17: 132 kW 18: 160 kW 19: 200 kW 20: 220 kW 21: 280 kW 22: 375 kW 65535: 0.4 kW
0h0002	Inverter input voltage	-	-	R	0: 220 V class 1: 400 V class
0h0003	Version	-	-	R	Ex.) 0x0100: Version 1.00 0x0101: Version 1.01
0h0004	Reserved	-	-	RW	-
0h0005	Command frequency	0.01	Hz	RW	-
0h0006	Operating command (option) * Refer to additional description	-	-	R	B15: Reserved B14: 0: Keypad Freq 1: Keypad Torq B13: 2-16: Terminal block Multi-step speed 17: Up 18: Down 19: STEADY B12: 20: AUTO-A 21: AUTO-B 22: V1 B11: 23: I1 24: V2 25: I2 B10: 26: Reserved 27: Built-in485 28: Communication option B9: 29: PLC option 30: JOG 31: PID B8: 0: Keypad 1: FX/RX-1 2: FX/RX-2 B7: 3: Built-in 485 4: Communication option B6: 5: PLC option

Address	Parameter	Scale	nit	R/W	Assigned content by bit																																
				R/W	<table border="1"> <tr><td>B5</td><td>Reserved</td></tr> <tr><td>B4</td><td>Emergency stop</td></tr> <tr><td>B3</td><td>W: Trip reset (0 ->1) R: Trip status</td></tr> <tr><td>B2</td><td>Reverse operation (R)</td></tr> <tr><td>B1</td><td>Forward operation (F)</td></tr> <tr><td>B0</td><td>Stop (S)</td></tr> </table>	B5	Reserved	B4	Emergency stop	B3	W: Trip reset (0 ->1) R: Trip status	B2	Reverse operation (R)	B1	Forward operation (F)	B0	Stop (S)																				
B5	Reserved																																				
B4	Emergency stop																																				
B3	W: Trip reset (0 ->1) R: Trip status																																				
B2	Reverse operation (R)																																				
B1	Forward operation (F)																																				
B0	Stop (S)																																				
0h0007	Acceleration time	0.1	sec	R/W	-																																
0h0008	Deceleration time	0.1	sec	R/W	-																																
0h0009	Output current	0.1	A	R	-																																
0h000A	Output frequency	0.01	Hz	R	-																																
0h000B	Output voltage	1	V	R	-																																
0h000C	DC Link voltage	1	V	R	-																																
0h000D	Output power	0.1	kW	R	-																																
0h000E	Operation status	-	-	-	<table border="1"> <tr><td>B15</td><td>0: Remote, 1: Keypad Local</td></tr> <tr><td>B14</td><td>1: Frequency command by comm. (Built-in type, Option)</td></tr> <tr><td>B13</td><td>1: Run command by comm. (Built-in type, Option)</td></tr> <tr><td>B12</td><td>Reverse direction run command</td></tr> <tr><td>B11</td><td>Forward direction run command</td></tr> <tr><td>B10</td><td>Brake open signal</td></tr> <tr><td>B9</td><td>Jog mode</td></tr> <tr><td>B8</td><td>Stopping</td></tr> <tr><td>B7</td><td>DC Braking</td></tr> <tr><td>B6</td><td>Speed reached</td></tr> <tr><td>B5</td><td>Decelerating</td></tr> <tr><td>B4</td><td>Accelerating</td></tr> <tr><td>B3</td><td>Operates depending on the set value of Fault (Trip) *OUT-30 Trip Out Mode</td></tr> <tr><td>B2</td><td>Reverse operation</td></tr> <tr><td>B1</td><td>Forward operation</td></tr> <tr><td>B0</td><td>Stopped</td></tr> </table>	B15	0: Remote, 1: Keypad Local	B14	1: Frequency command by comm. (Built-in type, Option)	B13	1: Run command by comm. (Built-in type, Option)	B12	Reverse direction run command	B11	Forward direction run command	B10	Brake open signal	B9	Jog mode	B8	Stopping	B7	DC Braking	B6	Speed reached	B5	Decelerating	B4	Accelerating	B3	Operates depending on the set value of Fault (Trip) *OUT-30 Trip Out Mode	B2	Reverse operation	B1	Forward operation	B0	Stopped
B15	0: Remote, 1: Keypad Local																																				
B14	1: Frequency command by comm. (Built-in type, Option)																																				
B13	1: Run command by comm. (Built-in type, Option)																																				
B12	Reverse direction run command																																				
B11	Forward direction run command																																				
B10	Brake open signal																																				
B9	Jog mode																																				
B8	Stopping																																				
B7	DC Braking																																				
B6	Speed reached																																				
B5	Decelerating																																				
B4	Accelerating																																				
B3	Operates depending on the set value of Fault (Trip) *OUT-30 Trip Out Mode																																				
B2	Reverse operation																																				
B1	Forward operation																																				
B0	Stopped																																				
0h000F	Fault trip information	-	-	R	<table border="1"> <tr><td>B15</td><td>Reserved</td></tr> <tr><td>B14</td><td>Reserved</td></tr> <tr><td>B13</td><td>Reserved</td></tr> <tr><td>B12</td><td>Reserved</td></tr> <tr><td>B11</td><td>Reserved</td></tr> </table>	B15	Reserved	B14	Reserved	B13	Reserved	B12	Reserved	B11	Reserved																						
B15	Reserved																																				
B14	Reserved																																				
B13	Reserved																																				
B12	Reserved																																				
B11	Reserved																																				

Communication Function

Address	Parameter	Scale	nit	R/W	Assigned content by bit	
					B10	H/W-Diag
					B9	Reserved
					B8	Reserved
					B7	Reserved
					B6	Reserved
					B5	Reserved
					B4	Reserved
					B3	Level Type Trip
					B2	Reserved
					B1	Reserved
					B0	Latch Type Trip
0h0010	Input terminal information	-	-	R	B15	Reserved
					B14	Reserved
					B13	Reserved
					B12	Reserved
					B11	Reserved
					B10	P11 (I/O expansion)
					B9	P10 (I/O expansion)
					B8	P9 (I/O expansion)
					B7	P8
					B6	P7
					B5	P6
					B4	P5
					B3	P4
					B2	P3
					B1	P2
B0	P1					
0h0011	Output terminal information	-	-	R	B15	Reserved
					B14	Reserved
					B13	Reserved
					B12	Reserved
					B11	Reserved
					B10	Reserved
					B9	Reserved
					B8	Reserved
B7	Reserved					

Address	Parameter	Scale	nit	R/W	Assigned content by bit	
					Bit	Content
					B6	Reserved
					B5	Relay 5 (I/O expansion)
					B4	Relay 4 (I/O expansion)
					B3	Relay 3(I/O expansion)
					B2	Q1
					B1	Relay 2
					B0	Relay 1
0h0012	V1	0.01	%	R	V1 voltage input	
0h0013	V2	0.01	%	R	V2 voltage input (expansion I/O)	
0h0014	I1	0.01	%	R	I1 current input	
0h0015	Motor rotation speed	1	rpm	R	Current motor rotation speed displayed	
0h0016-0h0019	Reserved	-	-	-	-	
0h001A	Hz/rpm selection	-	-	R	0: Hz unit 1: rpm unit	
0h001B	Motor poles displayed	-	-	R	Motor poles displayed	

11.13.4 Expansion Common Area Parameter

11.13.4.1 Inverter Monitoring Area Parameter (Read only)

Address	Parameter	Scale	unit	Assigned content by bit
0h0300	Inverter model	-	-	iS7: 000Bh
0h0301	Inverter capacity	-	-	0.75 kW: 3200h 1.5 kW: 4015h, 2.2 kW: 4022h, 3.7kW: 4037h, 5.5 kW: 4055h, 7.5 kW: 4075h, 11 kW: 40B0h 15 kW: 40F0h, 18.5 kW: 4125h, 22 kW: 4160h, 30 kW: 41E0h, 37 kW: 4250h, 45 kW: 42D0h 55 kW: 4370h, 75 kW: 44B0h, 90 kW: 45A0h 110 kW: 46E0h, 132 kW: 4840h, 160 kW: 4A00h 185 kW: 4B90h
0h0302	Inverter input voltage / power supply type (single phase, 3 phase) / cooling method	-	-	200 V single phase open air cooling: 0220h 200 V 3 phase open air cooling: 0230h 200 V single phase forced cooling: 0221h 200 V 3 phase forced cooling: 0231h 400 V single open air cooling: 0420h 400 V 3 phase open air cooling: 0430h 400 V single phase forced cooling: 0421h 400 V 3 phase forced cooling: 0431h
0h0303	Inverter S/W version	-	-	Ex.) 0x0100: Version 1.00 0x0101: Version 1.01
0h0304	Reserved	-	-	-
0h0305	Inverter operating status	-	-	B15 B14 B13 B12 B11 B10 B9 B8 0000(0) : Normal status 0100(4): Warning status 1000(8): Fault status (operates according to set value of OUT-30 Trip Out Mode)

Address	Parameter	Scale	unit	Assigned content by bit					
				B7	0001(1): Speed search 0010(2): Accelerating				
				B6	0011(3): Steady speed 0100(4): Decelerating				
				B5	0101(5): Decelerating stop 0110(6): HW OCS				
				B4	0111(7): S/W OCS 1000(8): Dwell operating				
				B3					
				B2	0000(0): Stop 0001(1): Forward operating				
				B1	0010(2): Reverse operating 0011(3): DC operating (0 speed control)				
				B0					
				0h0306	Inverter run frequency command source	-	-	B15	
								B14	Run command source
								B13	00000000(0):Keypad 00000001(1):Communication option
								B12	00000010(2):App/PLC 00000011(3):Built-in 485
								B11	00000100(4):Terminal Block 00000101(5):reserved
								B10	00000110(6):Auto 1 00000111(7):Auto 2
								B9	
B8									
B7	Frequency command source								
B6	00000000(0):Keypad speed 00000001(1):Keypad torque								
B5	00000010~00000100(2~4):Up/Down run speed								
B4	00000101(5): V1 00000110(6): I1 00000111(7): V2 00001000(8): I2								
B3	00001001(9): Pulse 00001010(10):Built-in 485								
B2	00001011(11):Comm option 00001100(12): App(PLC)								
B1	00001101(13): Jog 00001110(14): PID 00001111~00001011(15~22) : Auto Step 00011001~00100111(25~39) : Multi-step speed frequency								
B0									
0h0307	Keypad S/W version	-	-	Ex.) 0x0100: Version 1.00					
0h0308	Keypad Title version	-	-	0x0101: Version 1.01					
0h0309 - 0h30F	Reserved	-	-	-					

Communication Function

Address	Parameter	Scale	unit	Assigned content by bit	
0h0310	Output current	0.1	A	-	
0h0311	Output frequency	0.01	Hz	-	
0h0312	Output RPM	0	RPM	-	
0h0313	Motor feedback speed	0	RPM	-32768rpm - 32767rpm (Having a polarity.)	
0h0314	Output voltage	1	V	-	
0h0315	DC Link voltage	1	V	-	
0h0316	Output power	0.1	kW	-	
0h0317	Output torque	0.1	%	Exception: It is not calculated during V/F control.	
0h0318	PID reference	0.1	%	-	
0h0319	PID feedback	0.1	%	-	
0h031A	Number of No.1 motor display	-	-	Number of No.1 motor display	
0h031B	Number of No.2 motor display	-	-	Number of No.2 motor display	
0h031C	Number of selected motor display	-	-	Number of selected motor display	
0h031D	Selection among Hz/rpm	-	-	0: Hz unit 1: rpm unit	
0h031E -0h031F	Reserved	-	-	-	
0h0320	Digital input information	-	-	B15	Reserved
				B14	Reserved
				B13	Reserved
				B12	Reserved
				B11	Reserved
				B10	P11 (I/O expansion)
				B9	P10 (I/O expansion)
				B8	P9 (I/O expansion)
				B7	P8 (Basic I/O)
				B6	P7 (Basic I/O)
				B5	P6 (Basic I/O)
B4	P5 (Basic I/O)				
B3	P4 (Basic I/O)				

Address	Parameter	Scale	unit	Assigned content by bit	
				B2	P3 (Basic I/O)
				B1	P2 (Basic I/O)
				B0	P1 (Basic I/O)
0h0321	Digital output information	-	-	B15	Reserved
				B14	Reserved
				B13	Reserved
				B12	Reserved
				B11	Reserved
				B10	Reserved
				B9	Reserved
				B8	Reserved
				B7	Reserved
				B6	Reserved
				B5	Relay 5 (I/O expansion)
				B4	Relay 4 (I/O expansion)
				B3	Relay 3 (I/O expansion)
				B2	Q1 (Basic I/O)
				B1	Relay 2 (Basic I/O)
				B0	Relay 1 (Basic I/O)
0h0322	Virtual digital input information	-	-	B15	Virtual DI 16 (COM85)
				B14	Virtual DI 15 (COM84)
				B13	Virtual DI 14 (COM83)
				B12	Virtual DI 13 (COM82)
				B11	Virtual DI 12 (COM81)
				B10	Virtual DI 11 (COM80)
				B9	Virtual DI 10 (COM79)
				B8	Virtual DI 9 (COM78)
				B7	Virtual DI 8 (COM77)
				B6	Virtual DI 7 (COM76)

Communication Function

Address	Parameter	Scale	unit	Assigned content by bit	
				B5	Virtual DI 6 (COM75)
				B4	Virtual DI 5 (COM74)
				B3	Virtual DI 4 (COM73)
				B2	Virtual DI 3 (COM72)
				B1	Virtual DI 2 (COM71)
				B0	Virtual DI 1 (COM70)
0h0323	Selected motor display	-	-	0: No.1 motor / 1: No.2 motor	
0h0324	AI1	0.01	%	Analog input1 (Basic I/O)	
0h0325	AI2	0.01	%	Analog input2 (Basic I/O)	
0h0326	AI3	0.01	%	Analog input3 (I/O expansion)	
0h0327	AI4	0.01	%	Analog input4 (I/O expansion)	
0h0328	AO1	0.01	%	Analog output1 (Basic I/O)	
0h0329	AO2	0.01	%	Analog output2 (Basic I/O)	
0h032A	AO3	0.01	%	Analog output3 (I/O expansion)	
0h032B	AO4	0.01	%	Analog output4 (I/O expansion)	
0h032C	Reserved	-	-	-	
0h032D	Temperature	1	°C	-	
0h032E	Power consumption of inverter(kW/hour)	0.1	kWh	-	
0h032F	Power consumption of inverter(MW/hour)	1	MWh	-	
0h0330	Latch type trip information-1			B15	Fuse Open Trip
				B14	Overheat Trip
				B13	Arm Short
				B12	External Trip
				B11	Overvoltage Trip
				B10	Overcurrent Trip
				B9	NTC Trip
				B8	Overspeed Deviation
				B7	Overspeed
B6	Input open-phase trip				

Address	Parameter	Scale	unit	Assigned content by bit	
				B5	Output open-phase trip
				B4	Ground Fault Trip
				B3	E-Thermal Trip
				B2	Inverter Overload Trip
				B1	Underload Trip
				B0	Overload Trip
0h0331	Latch type trip information-2	-	-	B15	Low Voltage2
				B14	Reserved
				B13	Inverter output cutoff by terminal block input on Safety Option (applied to above 90 kW)
				B12	Slot3 option board contact defectiveness
				B11	Slot2 option board contact defectiveness
				B10	Slot1 option board contact defectiveness
				B9	No MotorTrip
				B8	External Brake Trip
				B7	Basic IO board contact defectiveness
				B6	Pre PID Fail
				B5	Error on Parameter Write
				B4	Reserved
				B3	FAN Trip
				B2	PTC (Thermal sensor) Trip
B1	Encoder Error Trip				
B0	MC Fail Trip				
0h0332	Level type trip information	-	-	B15	Reserved
				B14	Reserved
				B13	Reserved
				B12	Reserved
				B11	Reserved
				B10	Reserved
				B9	Reserved

Communication Function

Address	Parameter	Scale	unit	Assigned content by bit	
				B8	Reserved
				B7	Reserved
				B6	Reserved
				B5	Reserved
				B4	Reserved
				B3	Keypad Lost Command
				B2	Lost Command
				B1	LV
				B0	BX
0h0333	H/W Diagnosis Trip information	-	-	B15	Reserved
				B14	Reserved
				B13	Reserved
				B12	Reserved
				B11	Reserved
				B10	Reserved
				B9	Reserved
				B8	Reserved
				B7	Reserved
				B6	Reserved
				B5	Reserved
				B4	Gate Drive Power Loss
				B3	Watchdog-2 error
B2	Watchdog-1 error				
B1	EEPROM error				
B0	ADC error				
0h0334	Warning information	-	-	B15	Reserved
				B14	Reserved
				B13	Reserved
				B12	Reserved

Address	Parameter	Scale	unit	Assigned content by bit	
				Bit	Content
				B11	Reserved
				B10	Fire function operation
				B9	Auto Tuning fail
				B8	Keypad Lost
				B7	Encoder mis-wiring
				B6	Encoder mis-installation
				B5	DB
				B4	FAN operation
				B3	Lost command
				B2	Inverter Overload
				B1	Underload
				B0	Overload
0h0335–0h033F	Reserved	-	-	-	
0h0340	On Time date	0	Day	Date of inverter power On	
0h0341	On Time minute	0	Min	Total minute, except for total date, of inverter On Time	
0h0342	Run Time date	0	Day	Total number of days of inverter run	
0h0343	Run Time minute	0	Min	Total minute, except for total day, of Run Time	
0h0344	Fan Time date	0	Day	Total days of cooling fan run	
0h0345	Fan Time minute	0	Min	Total minute except for total day of Fan time	
0h0346	Reserved	-	-	-	
0h0347	Reserved	-	-	-	
0h0348	Reserved	-	-	-	
0h0349	Reserved	-	-	-	
0h034A	Option 1	-	-	0: None 2: Reserved 4: Reserved 6: Reserved 8: Reserved 10: PLC 23: Encoder	1: Reserved 3: Profibus, 5: Reserved 7: RNet, 9: Reserved 20: External IO-1
0h034B	Option 2	-	-		
0h034C	Option 3				

11.13.4.2 Inverter Control Area Parameter (Reading and Writing Available)

Address	Parameter	Scale	unit	Bit allotment	
0h0380 <small>note1)</small>	Frequency command	0.01	Hz	Command frequency setting	
0h0381	RPM command	1	rpm	command RPM setting	
0h0382	Operating command	-	-	B7	Reserved
				B6	Reserved
				B5	Reserved
				B4	Reserved
				B3	0→1: Free run stop
				B2	0→1: Trip reset
				B1	0:Reverse command 1:Forward command
				B0	0:Stop command 1:Run command
Ex) Forward operating command: 0003h, Reverse operating command: 0001h					
0h0383	Accelerating time	0.1	sec	Accelerating time setting	
0h0384	Decelerating time	0.1	sec	Decelerating time setting	
0h0385	Virtual digital input control (0:Off, 1:On)	-	-	B15	Virtual DI 16 (COM85)
				B14	Virtual DI 15 (COM84)
				B13	Virtual DI 14 (COM83)
				B12	Virtual DI 13 (COM82)
				B11	Virtual DI 12 (COM81)
				B10	Virtual DI 11 (COM80)
				B9	Virtual DI 10 (COM79)
				B8	Virtual DI 9 (COM78)
				B7	Virtual DI 8 (COM77)
				B6	Virtual DI 7 (COM76)
				B5	Virtual DI 6 (COM75)
				B4	Virtual DI 5 (COM74)
				B3	Virtual DI 4 (COM73)
				B2	Virtual DI 3 (COM72)
B1	Virtual DI 2 (COM71)				

Address	Parameter	Scale	unit	Bit allotment	
0h0386	Digital output control (0:Off, 1:On)	-	-	B0	Virtual DI 1 (COM70)
				B15	Reserved
				B14	Reserved
				B13	Reserved
				B12	Reserved
				B11	Reserved
				B10	Reserved
				B9	Reserved
				B8	Reserved
				B7	Reserved
				B6	Reserved
				B5	Q4 (I/O expansion, OUT36:None)
				B4	Q3 (I/O expansion, OUT35:None)
				B3	Q2 (I/O expansion, OUT34:None)
B2	Q1 (basic I/O, OUT33:None)				
B1	Relay2 (basic I/O, OUT32:None)				
B0	Relay1 (basic I/O, OUT31:None)				
0h0387	Reserved	-	-	Reserved	
0h0388	PID reference	0.1	%	PID reference command released	
0h0389	PID feedback value	0.1	%	PID feedback value	
0h038A -0h038F	Reserved	-	-	-	
0h0390	Torque Ref	0.1	%	Torque command	
0h0391	Fwd Pos Torque Limit	0.1	%	Forward motor ring torque limit	
0h0392	Fwd Neg Torque Limit	0.1	%	Forward regenerative torque limit	
0h0393	Rev Pos Torque Limit	0.1	%	Reverse motor ring torque limit	
0h0394	Rev Neg Torque Limit	0.1	%	Reverse regenerative torque limit	
0h0395	Torque Bias	0.1	%	Torque Bias	
0h0395	Reserved	-	-	-	

Communication Function

Address	Parameter	Scale	unit	Bit allotment
-0h399				
0h039A	Anytime Para	-	-	CNF-20 value setting
0h039B	Monitor Line-1	-	-	CNF-21 value setting
0h039C	Monitor Line-2	-	-	CNF-22 value setting
0h039D	Monitor Line-3	-	-	CNF-23 value setting

- Note1) A frequency set via communication using the iS7 common area frequency address (0h0380, 0h0005) is not saved even when used with the parameter save function. To save a changed frequency to use after a power cycle, follow these steps:
 - Set DRV-07 to Keypad-1 and select a random target frequency.
 - Cmd Frequency (DRV-01, 0h1101): Set the frequency via communication into the parameter area frequency address (0h1101).
 - Parameter Save (0h03E0): Set to "1" before turning off the power.
 - The frequency set via communication will be displayed after turning the power off and on again.

11.13.4.3 Inverter Memory Control Area Parameter (Reading and Writing Available)

When setting parameters in the inverter memory control area, the values are reflected to the inverter operation and saved. Parameters set in other areas via communication are reflected in the inverter operation, but are not saved.

All set values are cleared following an inverter power cycle and revert back to their previous values. When setting parameters via communication, ensure that a parameter is saved prior to turning off the inverter.

Address	Parameter	Scale	unit	Changeable During Operation	Function	Page
0h03E0 ^{note1)}	Parameter saving	-	-	X	0: No 1: Yes	256
0h03E1 ^{note1)}	Monitor mode initialization	-	-	O	0: No 1: Yes	257
0h03E2 ^{note1)}	Parameter initialization	-	-	X	0: No 1: All Grp 2: Drv Grp 3: BAS Grp 4: ADV Grp 5: CON Grp 6: IN Grp 7: OUT Grp 8: COM Grp 9: APP Grp 10: AUT Grp 11: APO Grp 12: PRT Grp 13: M2 Grp *No setting during trip	257
0h03E3	Display changed parameter	-	-	O	0: No 1: Yes	260
0h03E4	Macro function item	-	-	X	0: None 1: Draw App 2: Traverse	262
0h03E5 ^{note1)}	Deleted all fault history	-	-	O	0: No 1: Yes	260
0h03E6 ^{note1)}	User registration code deleted	-	-	O	0: No 1: Yes	260
0h03E7 ^{note 2)}	Hide parameter mode	0	Hex	O	writing: 0 - 9999 reading: 0: Unlock 1: Lock	258
0h03E8 ^{note 2)}	Lock parameter mode	0	Hex	O	writing: 0 - 9999 reading: 0: Unlock 1: Lock	259
0h03E9	Easy start on (easy parameter setup mode)	-	-	O	0: No 1: Yes	263
0h03EA ^{note1)}	Initializing power consumption	-	-	O	0: No 1: Yes	284
0h03EB ^{note1)}	Initialize inverter operation accumulative time	-	-	O	0: No 1: Yes	284
0h03EC ^{note1)}	Initialize cooling	-	-	O	0: No 1: Yes	264

Address	Parameter	Scale	unit	Changeable During Operation	Function	Page
	fan accumulated operation time					

Note 1

- Set parameters very carefully. After setting a parameter to "0 " via communication, set it to another value. If a parameter has been set to a value other than 0 and a non-zero value is entered again, an error message is returned. The previously set value can be identified by reading the parameter when operating the inverter via communication.

Note that the execution time may take longer because the data is saved in the inverter, possibly interrupting communication.

Note 2

- The addresses 0h03E7 and 0h03E8 are parameters for entering the password. When the password is entered, the condition will change from "Lock" to "Unlock", and vice versa.

When the same parameter value is entered repeatedly, the parameter setting is executed just once. To enter the same value, change it to another value first and then re-enter the previous value. For example, if you want to enter 244 twice, enter it in the following order: 244 -> 0 -> 244.

12 Troubleshooting and Maintenance

This chapter explains how to troubleshoot a problem when inverter protective functions, fault trips, warning signals, or faults occur. If the inverter does not work normally after following the suggested troubleshooting steps, please contact the LS ELECTRIC Customer Support.

Danger

Wait at least 10 minutes before opening the covers and exposing the terminal connections. Before working on the inverter, test the connections to ensure the DC voltage has been fully discharged. Personal injury or death by electric shock may result if the DC voltage has not been discharged.

12.1 Protection Functions

12.1.1 Protection from Output Current and Input Voltage

Type	Category	Details	Remarks
Over Load	Latch	Displayed when the motor overload trip is activated and the actual load level exceeds the set level. Operates when PRT-20 is set to any value other than "0".	-
Under Load	Latch	Displayed when the motor underload trip is activated and the actual load level is less than the set level. Operates when PRT-27 is set to any value other than "0".	-
Over Current1	Latch	Displayed when the inverter output current exceeds 200% of the rated current.	-
Over Voltage	Latch	Displayed when the internal DC circuit voltage exceeds the specified value.	-
Low Voltage	Level	Displayed when the internal DC circuit voltage is less than the specified value.	-
Ground Trip	Latch	Displayed when a ground fault trip occurs on the output side of the inverter and causes the current to exceed the specified value. The specified value varies depending on the inverter capacity.	-
E-Thermal	Latch	Displayed based on inverse time limit thermal characteristics to prevent motor overheating. Operates when PRT-40 is set to any value other than "0".	-
Out Phase Open	Latch	Displayed when a 3-phase inverter output has one or more phases in an open circuit condition. Operates when bit 1 of PRT-05 is set to "1".	-

Troubleshooting and Maintenance

Type	Category	Details	Remarks
In Phase Open	Latch	Displayed when a 3-phase inverter input has one or more phases in an open circuit condition. Operates only when bit 2 of PRT-05 is set to "1".	-
Inverter OLT	Latch	Displayed when the inverter has been protected from overload and resultant overheating, based on inverse time limit thermal characteristics. Allowable overload rates for the inverter are 150% for 1 min and 200% for 4 sec. Protection is based on the inverter rated capacity, and may vary depending on the device's capacity.	-
Low Voltage2	Latch	Displayed when the internal DC circuit voltage is less than the specified value during inverter operation.	-
Safety Opt Err	Latch	Displayed when a safety feature is activated to block the inverter output during an emergency.	-

12.1.2 Abnormal Circuit Conditions and External Signals

Type	Category	Details	Remarks
Fuse Open	Latch	Displayed when the inverter DC fuse is exposed to an overcurrent above 30 kW.	-
Over Heat	Latch	Displayed when the temperature of the inverter heat sink exceeds the specified value.	-
Over Current2	Latch	Displayed when the DC circuit in the inverter detects a specified level of excessive, short circuit current.	-
External Trip	Latch	Displayed when an external fault signal is provided by the multi-function terminal. Set one of the multi-function input terminals at IN-65–72 to "3 (External Trip)" to enable external trip.	-
BX	Level	Displayed when the inverter output is blocked by a signal provided from the multi-function terminal. Set one of the multi-function input terminals at IN-65–71 to "4 (BX)" to enable the input block function.	-
HW-Diag	Fatal	Displayed when an error is detected in the memory (EEPROM), analog-digital converter output (ADC Off Set), or CPU watchdog (Watch Dog-1, Watch Dog-2). EEP Err: An error in reading/writing parameters due to a keypad or memory (EEPROM) fault. ADC Off Set: An error in the current sensing circuit (U/V/W terminal, current sensor, etc.). Gate Pwr Loss: An interruption in the supply of power to the IGBT Gate of a product rated 30 kW or higher (when a fault occurs in a 22 kW-rated product, the capacity settings should be	-

Type	Category	Details	Remarks
		checked).	
NTC Open	Latch	Displayed when an error is detected in the temperature sensor of the Insulated Gate Bipolar Transistor (IGBT).	-
Fan Trip	Latch	Displayed when an error is detected in the cooling fan. Set PRT-79 to "0" to activate fan trip (for models with a capacity below 22 kW).	-
IP54 FAN Trip	Latch	Displayed when the IP54 product detects an internal circulation at the cooling fan.	Only applied to IP54 product
Thermal Trip	Latch	Displayed when the resistance value exceeds the prescribed value after the external temperature sensor is connected to the terminal block. Operates when PRT-34 is set to any value other than "0".	-
ParaWrite Trip	Latch	Displayed when communication fails during parameter writing. Occurs when using an LCD keypad due to a control cable fault or a bad connection.	-
Over Speed Trip	Latch	Displayed when the motor speed exceeds the overspeed detection level. Set the detection level at PRT-70.	-
Dev Speed Trip	Latch	Displayed when the speed that received feedback from the encoder exceeds the set variation value. Operates when PRT-73 is set to "1".	-
Encoder Trip	Latch	Displayed when PRT-77 Enc Wire Check is set to "1" and an abnormality is detected for the set period of time.	-
Pre-PID Fail	Latch	Displayed when pre-PID is operating with functions set at APP-34–36. A fault trip occurs when a controlled variable (PID feedback) is measured below the set value and the low feedback continues, as it is treated as a load fault.	-
Ext-Brake	Latch	When Control Mode (DRV-09) is V/F or Sensorless1 or Sensorless2: The trip occurs when OUT-31–32 is set to BR control and the output current is lower than ADV-41 value (% for BAS-13) for about 10 seconds. When Control Mode (DRV-09) is Vector: The trip occurs when OUT-31-32 is set to BR Control and the current is lower than half of the BAS-14 value.	-

12.1.3 Keypad and Optional Expansion Modules

Type	Category	Details	Remarks
Lost Keypad	Level	Displayed when operating commands come from the keypad or there is any problem with the communication between the keypad and inverter's main body in Keypad JOG mode. Operates when PRT-11 is set to any value other than "0" (occurs 2 seconds after the communication is interrupted).	-
Lost Command	Level	Displayed when a frequency or operation command error is detected during inverter operation by controllers other than the keypad (e.g. using a terminal block and a communication mode). Set PRT-12 to any value other than "0".	-
Option Trip-1	Latch	Displayed when the extension module is removed from option slot No. 1 after it was installed while the inverter was turned on, or when communication is not available with the inverter.	-
Option Trip-2	Latch	Displayed when the extension module is removed from option slot No. 2 after it was installed during power supply, or when communication is not available with the inverter.	-
Option Trip-3	Latch	Displayed when the extension module is removed from option slot No. 3 after it was installed during power supply, or when communication is not available with the inverter.	-
I/O Board Trip	Latch	Displayed when the basic and insulated I/O boards are disconnected or have a connection fault.	-

Note

Level: When the fault is corrected, the trip or warning signal disappears and the fault is not saved in the fault history.

Latch: When the fault is corrected and a reset input signal is provided, the trip or warning signal disappears.

Fatal: When the fault is corrected, the fault trip or warning signal disappears only after the user turns off the inverter, waits until the charge indicator light goes off, and turns the inverter on again. If the inverter is still in a fault condition after it is powered on again, please contact the supplier or the LS ELECTRIC Customer Support.

The function for saving the fault history and the fault signal output may not be performed if the functions are not set or the inverter is seriously damaged.

12.2 Warning Messages

Type	Description
Over Load	Displayed when the motor is overloaded. Operates when PRT-17 is set to "1". To operate, select "4 (Over Load)". Set the digital output terminal or relay (OUT31-33) to "4 (Over Load)" to receive overload warning output signals.
Under Load	Displayed when the motor is underloaded. Operates when PRT-25 is set to "1". Set the digital output terminal or relay (OUT31-33) to "6 (Under Load)" to receive underload warning output signals.
Inv Over Load	Displayed when the accumulated overload time is equivalent to 60% of the inverter overheat protection (inverter IOLT) level. Set the digital output terminal or relay (OUT31-33) to "5 (IOL)" to receive inverter overload warning output signals.
Lost Command	The Lost Command warning alarm occurs even when PRT-12 is set to "0". The warning alarm occurs based on the condition set at PRT-13-15. Set the digital output terminal or relay (OUT31-33) to "12 (Lost Command)" to receive lost command warning output signals.
Fan Warning	Displayed when an error is detected from the cooling fan while PRT-79 is set to "1". Set the digital output terminal or relay (OUT31-33) to "8 (Fan Warning)" to receive fan warning output signals.
DB Warn %ED	Displayed when the DB resistor usage rate exceeds the set value. Set the detection level at PRT-66.
Enc Conn Check	Displayed when "3 (Enc Test)" is set at BAS-20 (Auto Tuning) and no signal is input during the encoder test. Set the ENC Tune at OUT31-33 to release a signal.
Enc Dir Check	Displayed when "3 (Enc Test)" is set at BAS-20 (Auto Tuning) and the settings for A and B encoder phases are changed or are the opposite during the encoder test. Set the ENC Dir at OUT31-33 to release a signal.
Lost Keypad	Displayed when operating commands come from the keypad or there is any problem with the communication between the keypad and inverter's main body in Keypad JOG mode after setting PRT-11 (Lost KPD Mode) to "0". Set the Lost Keypad (29) at OUT31-33.
Check Line PLZ	Displayed when there is any problem with communication between the keypad and the iS7 Control CPU (control connection cables).
Fire Mode	Displayed when the fire function is activated. If a contact signal output is required, set the Fire Mode (37) at OUT31-33.
PID Sleep	Displayed in PID Sleep mode. This warning is provided to distinguish the PID sleep mode from a stopped state.
AUX Power On	Displayed when the control power is supplied with the auxiliary power module. If the auxiliary power module has been installed, an AUX Power On warning is provided instead of a Low Voltage trip when the main power is turned off.

12.3 Troubleshooting Fault Trips

Type	Problem	Solution
Over Load	The load is greater than the motor's rated capacity.	Ensure that the motor and inverter have appropriate capacity ratings.
	The set value for the overload trip level (PRT-21) is too low.	Increase the set value for the overload trip level.
Under Load	There is a motor-load connection problem.	Replace the motor and inverter with lower capacity models.
	The set value for the underload level (PRT-29 and PRT-30) is less than the system's minimum load.	Increase the set value for the underload level.
Over Current1	Acc/dec time is too short compared to load inertia (GD2).	Increase acc/dec time.
	The inverter load is greater than the rated capacity.	Replace the inverter with a model that has increased capacity.
	The inverter supplied an output while the motor was idling.	Operate the inverter after the motor has stopped or use the speed search function (CON-60).
	The mechanical brake of the motor is operating too fast.	Check the mechanical brake.
Over Voltage	The deceleration time is too short for the load inertia (GD2).	Increase the deceleration time.
	A generative load occurs at the inverter output.	Use the braking unit.
	The input voltage is too high.	Check if the input voltage is above the specified value.
	The set value for electronic thermal protection is too low.	Set an appropriate electronic thermal level.
	The inverter has been operated at a low speed for an extended period.	Replace the motor with a model that supplies extra power to the cooling fan.
	The input voltage is too low.	Check if the input voltage is below the specified value.
Low Voltage /Low Voltage2	A load greater than the power capacity is connected to the system (e.g. a welder, direct motor connection, etc.)	Increase the power capacity.
	The magnetic contactor connected to the power source has a faulty connection.	Replace the magnetic contactor.
Ground Trip	A ground fault has occurred in the inverter output wiring.	Check the output wiring.

Type	Problem	Solution
E-Thermal	The motor insulation is damaged.	Replace the motor.
	The motor has overheated.	Reduce the load or operation frequency.
	The inverter load is greater than the rated capacity.	Replace the inverter with a model that has increased capacity.
Out Phase Open	The magnetic contactor on the output side has a connection fault.	Check the magnetic contactor on the output side.
	The output wiring is faulty.	Check the output wiring.
In Phase Open	The magnetic contactor on the input side has a connection fault.	Check the magnetic contactor on the input side.
	The input wiring is faulty.	Check the input wiring.
	The DC link capacitor needs to be replaced.	Replace the DC link capacitor. Contact the retailer or the LS ELECTRIC Customer Support.
Inverter OLT	The load is greater than the rated motor capacity.	Replace the motor and inverter with models that have increased capacity.
	The torque boost level is too high.	Reduce the torque boost level.
Over Heat	There is a problem with the cooling system.	Check if a foreign object is obstructing the air inlet, outlet, or vent.
	The inverter cooling fan has been operating for an extended period.	Replace the cooling fan.
	The ambient temperature is too high.	Keep the ambient temperature below 50°C.
Over Current2	The output wiring has short-circuited.	Check the output wiring.
	There is a fault with the electronic semiconductor (IGBT).	Do not operate the inverter. Contact the retailer or the LS ELECTRIC Customer Support.
NTC Open	The ambient temperature is too low.	Keep the ambient temperature above 10°C.
	There is a fault with the internal temperature sensor.	Contact the retailer or the LS ELECTRIC Customer Support.
FAN Trip	There is a foreign object in the inverter vent where the fan is located.	Remove the foreign object from the air inlet or outlet.
	The cooling fan needs to be replaced.	Replace the cooling fan.
IP54 FAN Trip	The fan connector is not connected.	Connect the fan connector.
	The power connector for the internal fan PCB board is not connected.	Connect the power connector for the internal fan PCB board.
	The cooling fan needs to be replaced.	Replace the cooling fan.

Troubleshooting and Maintenance

Type	Problem	Solution
No Motor Trip	The motor is not connected to the inverter output.	Check the wiring connections.
	The current level for trip detection is not set properly.	Check the values of both BAS-13 (Rated current) and PRT-32 (No Motor Level).

12.4 Replacing the Cooling Fan

12.4.1 Products Rated below 7.5 kW

To replace the cooling fan, push the bracket on the bottom in the direction of the arrows in the diagram below and then pull it forward. Then, disconnect the fan connector.

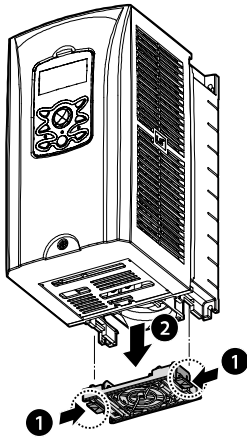

<Below 3.7 kW>

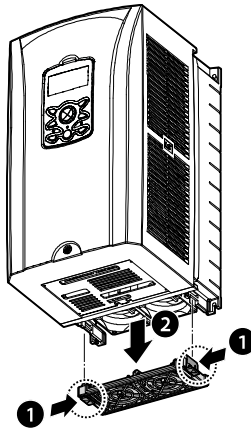

<Below 7.5 kW>

12.4.2 Products Rated at 11-15 kW 200 V/400 V and 18.5-22 kW 400 V

To replace the cooling fan, loosen the screws at the bottom of the input and output terminals and disconnect the fan connector.

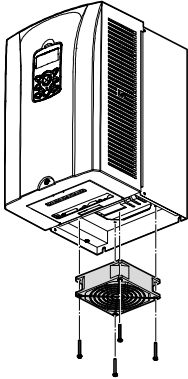

12.4.3 Products Rated at more than 30 kW (200 V) / 90 kW (400 V), and 18.5–22 kW (200 V) / 30–75 kW (200/400 V)

To replace the cooling fan, loosen the screws at the top of the product and disconnect the fan connector.

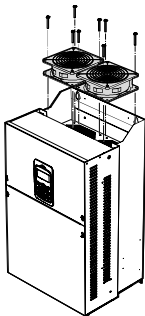

Model types > 30 kW (200 V) ,
Model types > 90 kW (400 V)

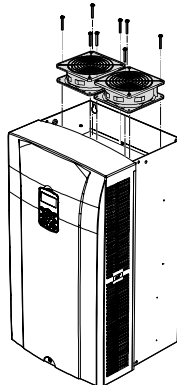

18.5–22 kW (200 V),
30–75 kW (400V)

12.5 Daily and Regular Inspection Lists

Inspection area	Inspection item	Inspection details	Inspection Cycle			Inspection method	Judgment standard	Inspection equipment
			Daily	Regular (Year)				
				1	2			
Total	Ambient environment	Is the ambient temperature and humidity within the designated range, and is there any dust or foreign objects present?	○			Visual inspection	No ice (ambient temperature: -10°C →+40°C) and no condensation (ambient humidity below 50%)	Thermometer, hygrometer, recorder
	Inverter	Are there any abnormal vibrations or noise?	○			Visual inspection	No abnormality	
	Power voltage	Are the input and output voltages normal?	○			Measure voltages between R/S/T phases in the inverter terminal block.		Digital multimeter, tester
Input/Output circuit	Total	1) Megger test (between input/output terminals and earth terminal) 2) Is there anything loose in the device? 3) Is there any evidence of overheating in each part? 4) Cleaning		○	○	1) Disconnect the inverter and short R/S/T/U/V/W terminals, and then measure from each terminal to the ground terminal using Megger test equipment. 2) Tighten up all screws. 3) Visual inspection	1) Over 5MΩ 2), 3) No matter	DC 500 V Megger
	Cable connections	1) Are there any corroded cables? 2) Is there any damage to cable insulation?		○		Visual inspection	No abnormality	
	Terminal block	Is there any damage?		○		Visual inspection	No abnormality	
	Smoothing condenser	1) Is liquid leaking inside? 2) Is the safety apparatus in position? Is there any protuberance?	○			1), 2) Visual inspection	1),2) No abnormality	Capacity meter
				○				

Function Table

Troubleshooting and Maintenance

Inspection area	Inspection item	Inspection details	Inspection Cycle		Inspection method	Judgment standard	Inspection equipment	
			Daily	Regular (Year)				
				1				2
		3) Check the power failure capacity.			3) Measure with a capacity meter.	3) Rated capacity over 85%		
	Relay	1) Is there any chattering noise during operation? 2) Is there any damage to the contacts?		0 0	1), 2) Visual inspection	1),2) No abnormality		
	Braking resistor	1) Is there any damage from resistance? 2) Check for disconnection.		0 0	1) Visual inspection 2) Disconnect one side and measure with a tester.	1) No abnormality 2) Must be within $\pm 10\%$ of the rated value of the resistor.	Digital multimeter / analog tester	

ⓘ Caution

Do not perform a megger test (insulation resistance test) on the control circuit of the inverter.

Inspection area	Inspection item	Inspection details	Inspection Cycle			Inspection method	Judgment standard	Inspection equipment
			Daily	Regular (Year)				
				1	2			
Control circuit Protection circuit	Operation check	1) Check for output voltage imbalance while the inverter is in operation. 2) Is there an error in the display circuit after the sequence protection test?		0		1) Measure voltage between the inverter output terminals U/V/W. 2) Test the inverter output protection in both short and open circuit conditions.	1) Balance the voltage between phases: within 4 V for 200 V series and within 8 V for 400 V series. 2) The circuit must work according to the sequence.	Digital multimeter or DC voltmeter
Cooling system	Cooling fan	1) Is there any abnormal vibration or sound? 2) Are any of the fan parts loose?	0	0		1) Turn it manually while the inverter is turned off. 2) Check all connected parts and tighten all screws.	1) It should turn smoothly. 2) No abnormality	
Display	Meter	Is the display value normal?	0	0		Check the command value on the display device.	Specified and managed values must match.	Voltmeter, ammeter, etc.
Motor	Total	1) Are there any abnormal vibrations or sound? 2) Is there any abnormal smell?	0	0		1) Visual inspection 2) Check the abnormality, such as overheating, damage, etc.	No abnormality	
	Isolation resistance	Megger test (between the input, output and earth terminals).			0	Disconnect the cables for terminals U/V/W and test the wiring.	Must be above 5 MΩ.	DC 500 V Megger

⚠ Caution

If the inverter has not been operated for a long time, capacitors lose their charging capability and are depleted. To prevent depletion, turn on the inverter once a year and allow it to operate for 30-60 minutes. Run the inverter under no-load conditions.

13 Table of Functions

13.1 Parameter Mode – DRV Group (→DRV)

DRV Group (PAR → DRV)

No.	Communication Address	LCD Display	Name	Setting Range	Initial Value	Shift in Operation	Page	Note1) Control Mode																											
								V / F	S L	V C	S L T	V C T																							
00	-	Jump Code	Jump code	1-99	9	O		O	O	O	O	O																							
01	0h1101	Cmd Frequency	Target frequency	Starting frequency -maximum frequency (Hz)	0.0	O	138	O	O	O	X	X																							
02	0h1102	Cmd Torque	Torque command	-180~180 (%)	0.0	O	236	X	X	X	O	O																							
03	0h1103	Acc Timed	Acceleration time	0~600 (sec)	Below 75 kW Above 90 kW	20.0 60.0	O	165	O	O	O	O	O																						
04	0h1104	Dec Time	Deceleration time	0~600 (sec)	Below 75 kW Above 90 kW	30.0 90.0	O	165	O	O	O	O	O																						
06	0h1106	Cmd Source	Command source	0	Keypad	1:Fx/Rx-1	X	157	O	O	O	O	O	O																					
				1	Fx/Rx-1																														
				2	Fx/Rx-2																														
				3	Int 485																														
				4	Field Bus																														
5	PLC																																		
07	0h1107	Freq Ref Src	Frequency reference source	0	Keypad-1	0:Keypad-1	X	138	O	O	O	X	X																						
				1	Keypad-2																														
				2	V1																														
08	0h1108	Trq Ref Src	Torque reference source	3	I1	0:Keypad-1	X	237	X	X	X	O	O	O	O																				
				4	V2																														
				5	I2																														
				6	Int 485																														
				7	Encoder																														
				8	FieldBus																														
				9	PLC																														
				10	Syncho																														
				11	Binary																														
				09 <small>Note1)</small>	0h1109														Control Mode	Control mode	0	V/F	0:V/F	X	267	O	O	O	O	O	O				
																					1	V/F PG													
2	Slip Compen																																		
3	Sensorless-1																																		
4	Sensorless-2																																		
5	Vector																																		
		225																																	
		210																																	
		225																																	
		227																																	
		238																																	

* The grey cells indicate a hidden code which is only visible when setting a code.

Note 1) Effectiveness of each code according to the Control Mode setting.

V/F: V/Fmode (PG included), SL: Sensorless-1, 2 mode, VC: Vector mode, SLT: Sensorless-1, 2 Torque mode,

VCT: Vector Torque mode,

Refer to the Options manual for options.

DRV Group (PAR → DRV)

No.	Communication Address	LCD Display	Name	Setting Range	Initial Value	Shift in Operation	Page	Control Mode				
								V / F	S L	V L C T	V L C T	
10	0h110A	Torque Control	Torque control	0 No 1 Yes	0: No	X	225	X	X	X	O	O
11	0h110B	Jog Frequency	Jog frequency	0.5–maximum frequency (Hz)	10.00	O	199	O	O	O	O	O
12	0h110C	Jog Acc Time	Jog run acceleration time	0–600 (sec)	20.0	O	199	O	O	O	O	O
13	0h110D	Jog Dec Time	Jog run deceleration time	0–600 (sec)	30.0	O	199	O	O	O	X	X
14	0h110E	Motor Capacity	Motor capacity	0:0.2kW, 1:0.4kW 2:0.75kW, 3:1.5kW 4:2.2kW, 5:3.7kW 6:5.5kW, 7:7.5kW 8:11kW, 9:15kW 10:18.5kW, 11:22kW 12:30kW, 13:37kW 14:45kW, 15:55kW 16:75kW, 17:90kW 18:110kW, 9:132kW 20:160kW, 1:185kW 22:220kW,23:280kW 24:315kW,25:375kW 26:450kW	Dependent on inverter capacity	X	211	O	O	O	O	O
15	0h110F	Torque Boost	Torque boost method	0 Manual 1 Auto 2 Advanced Auto	0:Manual	X	179	O	X	X	X	X
16 Note 2)	0h1110	Fwd Boost	Forward torque boost	0–15 (%)	Below 75kW 2.0 Above 90kW 1.0	X	179	O	X	X	X	X
17	0h1111	Rev Boost	Reverse torque boost	0–15(%)	Below 75kW 2.0 Above 90kW 1.0	X	179	O	X	X	X	X
18	0h1112	Base Freq	Base frequency	30–400 (Hz)	60.00	X	174	O	O	O	O	O
19	0h1113	Start Freq	Starting frequency	0.01–10 (Hz)	0.50	X	174	O	X	X	X	X
20	0h1114	Max Freq	Maximum frequency	40–400	60.00	X	186	O	O	O	O	O
21	0h1115	Hz/Rpm Sel	Speed unit selection	0 Hz Display 1 Rpm Display	0:Hz	O	287	O	O	O	O	O
25	0h1119	Output Freq	Output speed monitoring	0–Max Frequency	0.00	O	288	O	O	O	O	O

* The grey cells indicate a hidden code which is only visible when setting a code.

Note 2) DRV-16–17 displayed only when DRV-15 (Torque Boost) is set as “Manual” or “Advanced Auto”.

Function Table

Table of Functions

DRV Group (PAR → DRV)

No.	Communication Address	LCD Display	Name	Setting Range	Initial Value	Shift in Operation	Page	Control Mode							
								V / F	S L	V C	S L	V C			
26 <small>Note 2)</small>	0h111A	Adv ATB Filter	Adv ATB Filter	1~1000[msec]	100	O	179	X	X	X	O	O			
27	0h111B	Adv ATB M Gain	Adv ATB M Gain	0~300.0[%]	50.0	O	179	O	O	O	O	O			
28	0h111C	Adv ATB G Gain	Adv ATB G Gain	0~300.0[%]	50.0	O	179	O	O	O	O	O			
30	0h111E	kW/HP Select	kW/HP Select	<table border="1" style="display: inline-table; vertical-align: middle;"> <tr> <td>0</td> <td>kW</td> </tr> <tr> <td>1</td> <td>HP</td> </tr> </table>	0	kW	1	HP	0: kW	O	282	O	O	X	X
0	kW														
1	HP														
87	0h1157	Code Version	Inverter Code Version	-	-	X	-	O	O	O	O				

* The grey cells indicate a hidden code which is only visible when setting a code.

Note 3) DRV-26~28 code is displayed only when DRV-15 (Torque Boost) code value is "Advanced Auto

13.2 Parameter Mode – Basic Function Group (→BAS)

BAS Group(PAR → BAS)

No.	Communication Address	LCD Display	Name	Setting Range	Initial Value	Shift in Operation	Page	Control Mode					
								V / F	S / L	V / C	S / T	V / C / T	
00	-	Jump Code	Jump code	0-99	20	O		O	O	O	O	O	
01	0h1201	Aux Ref Src	Auxiliary reference source	0	None	0:None	X	194	O	O	O	X	X
				1	V1								
				2	I1								
				3	V2								
				4	I2								
				5	Pulse								
02 <small>Note 3)</small>	0h1202	Aux Calc Type	Auxiliary command calculation type	0	M+(G*A)	0: M+(G*A)	X	194	O	O	O	X	X
				1	M*(G*A)								
				2	M/(G*A)								
				3	M+(M*(G*A))								
				4	M+G*2(A-50%)								
				5	M*(G*2(A-50%))								
				6	M/(G*2(A-50%))								
7	M+M*G*2(A-50%)												
03	0h1203	Aux Ref Gain	Auxiliary command gain	-200.0-200.0 (%)	100.0	O		O	O	O	X	X	
04	0h1204	Cmd 2nd Src	Second command source	0	Keypad	1: Fx/Rx-1	X	190	O	O	O	O	O
				1	Fx/Rx-1								
				2	Fx/Rx-2								
				3	Int 485								
				4	FieldBus								
5	PLC												
05	0h1205	Freq 2nd Src	Second frequency source	0 Keypad-1	0:Keypad-1	O		O	O	O	X	X	

* The grey cells indicate a hidden code which is only visible when setting a code.

Note 3) BAS-02 code is displayed only when BAS-01 (Aux Ref Src) code has a value other than "None".

Function Table

Table of Functions

BAS Group (PAR → BAS)

No.	Communication Address	LCD Display	Name	Setting Range	Initial Value	Shift in Operation	Page	Control Mode				
								V/F	S/L	V/C	S/L	V/T
06	0h1206	Trq 2nd Src	Second torque command source	1 Keypad-2	0:Keypad-1	O	190	X	X	X	O	O
				2 V1								
				3 I1								
				4 V2								
				5 I2								
				6 Int 485								
				7 Encoder								
				8 FieldBus								
				9 PLC								
				10 Synchro								
				11 Binary Type								
				12 Keypad-2								
07	0h1207	V/F Pattern	V/F pattern options	0 Linear	0:Linear	X	175	O	O	X	X	X
				1 Square								
				2 User V/F								
08	0h1208	Ramp T Mode	Acc/Dec standard frequency	0 Max Freq	0:Max Freq	X	165	O	O	O	X	X
				1 Delta Freq								
09	0h1209	Time Scale	Time scale settings	0 0.01 sec	1:0.1 sec	X	165	O	O	O	X	X
				1 0.1 sec								
				2 1 sec								
10	0h120A	60/50 Hz Sel	Input power frequency	0 60 Hz	0:60 Hz	X	84	O	O	O	O	O
				1 50 Hz								
11	0h120B	Pole Number	Number of motor poles	248		X		O	O	O	O	O
12	0h120C	Rated Slip	Rated slip speed	0-3000 (rpm)	Dependent on inverter capacity	X		O	O	O	O	O
13	0h120D	Rated Curr	Motor rated current	1-1000 (A)		X		O	O	O	O	O
14	0h120E	Noload Curr	Motor no-load current	0.5-1000 (A)		X	211	O	O	O	O	O
15	0h120F	Rated Volt	Motor rated voltage	180-480 (V)	0	X		O	O	O	O	O
16	0h1210	Efficiency	Motor efficiency	70-100 (%)	Dependent on inverter capacity	X		O	O	O	O	O
17	0h1211	Inertia Rate	Load inertia rate	0-8		X		O	O	O	O	O
18	0h1212	Trim Power %	Power display adjustment	70-130 (%)		O	286	O	O	O	O	O
19	0h1213	AC Input Volt	Input power voltage	170-230 (V)	220 V	O	263	O	O	O	O	O
				380-480 (V)	44x0 V							
20	-	Auto Tuning	Auto tuning	0 None	0:None	X	220	X	O	O	O	O
				1 All								
				2 ALL(Stdstl)								
				3 Rs+Lsigma								
				4 Enc Test								
				5 Tr								
6 Tr(Stdstl)												

BAS Group (PAR → BAS)

No.	Communication Address	LCD Display	Name	Setting Range	Initial Value	Shift in Operation	Page	Control Mode				
								V/F	S/L	V/L	S/V	
21	-	Rs	Stator resistance	Dependent on motor setting	-	X	220	X	O	O	O	O
22	-	Lsigma	Leakage inductance	Dependent on motor setting	-	X	220	X	O	O	O	O
23	-	Ls	Stator inductance	Dependent on motor setting	-	X	220	X	O	O	O	O
24 <small>Note4)</small>	-	Tr	Rotor time constant	25-5000 (ms)	-	X	220	X	O	O	O	O
41 <small>Note5)</small>	0h1229	User Freq 1	User frequency 1	0-maximum frequency (Hz)	15.00	X	176	O	X	X	X	X
42	0h122A	User Volt 1	User voltage 1	0-100 (%)	25	X	176	O	X	X	X	X
43	0h122B	User Freq 2	User frequency 2	0-maximum frequency (Hz)	30.00	X	176	O	X	X	X	X
44	0h122C	User Volt 2	User voltage 2	0-100 (%)	50	X	176	O	X	X	X	X
45	0h122D	User Freq 3	User frequency 3	0-maximum frequency (Hz)	45.00	X	176	O	X	X	X	X
46	0h122E	User Volt 3	User voltage 3	0-100 (%)	75	X	176	O	X	X	X	X
47	0h122F	User Freq 4	User frequency 4	0-maximum frequency (Hz)	60.00	X	176	O	X	X	X	X
48	0h1230	User Volt 4	User voltage 4	0-100 (%)	100	X	176	O	X	X	X	X
50 <small>Note6)</small>	0h1232	Step Freq-1	Multi-step speed frequency 1	Starting frequency -maximum frequency(Hz)	10.00	O	154	O	O	O	X	X
51	0h1233	Step Freq-2	Multi-step speed frequency 2		20.00	O	154	O	O	O	X	X
52	0h1234	Step Freq-3	Multi-step speed frequency 3		30.00	O	154	O	O	O	X	X
53	0h1235	Step Freq-4	Multi-step speed frequency 4		40.00	O	154	O	O	O	X	X
54	0h1236	Step Freq-5	Multi-step speed frequency 5		50.00	O	154	O	O	O	X	X
55	0h1237	Step Freq-6	Multi-step speed frequency 6		60.00	O	154	O	O	O	X	X
56	0h1238	Step Freq-7	Multi-step speed frequency 7		60.00	O	154	O	O	O	X	X
57	0h1239	Step Freq-8	Multi-step speed frequency 8		55.00	O	154	O	O	O	X	X
58	0h123A	Step Freq-9	Multi-step speed frequency 9		50.00	O	154	O	O	O	X	X
59	0h123B	Step Freq-10	Multi-step speed frequency 10		45.00	O	154	O	O	O	X	X
60	0h123C	Step Freq-11	Multi-step speed frequency 11		40.00	O	154	O	O	O	X	X
61	0h123D	Step Freq-12	Multi-step speed frequency 12		35.00	O	154	O	O	O	X	X
62	0h123E	Step Freq-13	Multi-step speed frequency 13		25.00	O	154	O	O	O	X	X
63	0h123F	Step Freq-14	Multi-step speed frequency 14		15.00	O	154	O	O	O	X	X
64	0h1240	Step Freq-15	Multi-step speed frequency 15		5.00	O	154	O	O	O	X	X
70	0h1246	Acc Time-1	Multi-step acceleration time 1	0-600 (sec)	20.0	O	168	O	O	O	X	X
71	0h1247	Dec Time-1	Multi-step deceleration time 1	0-600 (sec)	20.0	O	168	O	O	O	X	X

Function Table

Table of Functions

No.	Communi- cation Address	LCD Display	Name	Setting Range	Initial Value	Shift in Opera- tion	Page	Control Mode				
								V / F	S L	V C	S L T	V C T
72 <small>Note7)</small>	0h1248	Acc Time-2	Multi-step acceleration time 2	0-600 (sec)	30.0	O	168	O	O	O	X	X
73	0h1249	Dec Time-2	Multi-step deceleration time 2	0-600 (sec)	30.0	O	168	O	O	O	X	X
74	0h124A	Acc Time-3	Multi-step acceleration time 3	0-600 (sec)	40.0	O	168	O	O	O	X	X
75	0h124B	Dec Time-3	Multi-step deceleration time 3	0-600 (sec)	40.0	O	168	O	O	O	X	X
76	0h124C	Acc Time-4	Multi-step deceleration time 4	0-600 (sec)	50.0	O	168	O	O	O	X	X
77	0h124D	Dec Time-4	Multi-step deceleration time 4	0-600 (sec)	50.0	O	168	O	O	O	X	X
78	0h124E	Acc Time-5	Multi-step deceleration time 5	0-600 (sec)	60.0	O	168	O	O	O	X	X
79	0h124F	Dec Time-5	Multi-step deceleration time 5	0-600 (sec)	60.0	O	168	O	O	O	X	X
80	0h1250	Acc Time-6	Multi-step deceleration time 6	0-600 (sec)	70.0	O	168	O	O	O	X	X
81	0h1251	Dec Time-6	Multi-step deceleration time 6	0-600 (sec)	70.0	O	168	O	O	O	X	X
82	0h1252	Acc Time-7	Multi-step deceleration time 7	0-600 (sec)	80.0	O	168	O	O	O	X	X
83	0h1253	Dec Time-7	Multi-step deceleration time 7	0-600 (sec)	80.0	O	168	O	O	O	X	X

*  The grey cells indicate a hidden code which is only visible when setting a code.

*  The grey cells indicate a hidden code which is only visible when setting a code.

Note 4) BAS-24 is shown only when DRV-09 Control Mode is set to "Sensorless-2" or "Vector".

Note 5) BAS-41-48 is displayed only when it is set as "User V/F" even if there is only one BAS-07 or M2-V/F Patt (M2-25).

Note 6) IN-50-64 is displayed only when it is set as "multi-step speed" (Speed -L,M,H,X) even if there is only one among multi-function input IN-65-72.

Note 7) displayed only when it is set as "multi-step Acc/Dec" (Xcel-L,M,H) even if there is only one among multi-function input IN-72-75.

13.3 Parameter Mode – Expansion Function Group (PAR→ADV)

Expansion Function Group (PAR → ADV)

No.	Communication Address	LCD Display	Name	Setting Range	Initial Value	Shift in Operation	Page	Control Mode				
								V / F	S L C	S L T	V C T	
00	-	Jump Code	Jump code	0-99	24	O	-	O	O	O	O	O
01	0h1301	Acc Pattern	Acceleration pattern	0 Linear	0:Linear	X	171	O	O	X	X	X
02	0h1302	Dec Pattern	Deceleration pattern	1 S-curve	0:Linear	X	171	O	O	X	X	X
03	0h1303	Acc S Start	S-curve acceleration start point gradient	1-100 (%)	40	X	171	O	O	X	X	X
04	0h1304	Acc S End	S-curve acceleration end point gradient	1-100 (%)	40	X	171	O	O	X	X	X
05	0h1305	Dec S Start	S-curve deceleration start point gradient	1-100 (%)	40	X	171	O	O	X	X	X
06	0h1306	Dec S End	S-curve deceleration end point gradient	1-100 (%)	40	X	171	O	O	X	X	X
07	0h1307	Start Mode	Start mode	0 Acc 1 Dc-Start	0:Acc	X	182	O	O	X	X	X
08	0h1308	Stop Mode	Stop mode	0 Dec 1 Dc-Brake 2 Free-Run 3 -Reserved- 4 Power Braking	0:Dec	X	184	O	O	X	X	X
09	0h1309	Run Prevent	Selection of prohibited rotation direction	0 None 1 Forward Prev 2 Reverse Prev	0:None	X	162	O	O	X	X	X
10	0h130A	Power-on Run	Start with power on	0 No 1 Yes	0:No	O	163	O	O	X	X	X
12 Note 8)	0h130C	Dc-Start Time	Starting DC braking time	0-60 (sec)	0.00	X	268	O	O	X	X	X
13	0h130D	Dc Inj Level	DC supply	0-200 (%)	50	X	268	O	O	X	X	X
14 Note 9)	0h130E	Dc-Block Time	Output blocking time before DC braking	0-60 (sec)	0.10	X	184	O	O	X	X	X
15	0h130F	Dc-Brake Time	DC braking time	0-60 (sec)	1.00	X	184	O	O	X	X	X
16	0h1310	Dc-Brake Level	DC braking rate	0-200 (%)	50	X	184	O	O	X	X	X
17	0h1311	Dc-Brake Freq	DC braking frequency	Starting frequency-60 (Hz)	5.00	X	184	O	O	X	X	X
20	0h1314	Acc Dwell Freq	Acceleration dwell frequency	Starting frequency -maximum frequency (Hz)	5.00	X	268	O	O	X	X	X
21	0h1315	Acc Dwell Time	Acceleration dwell operation time	0-60.0 (sec)	0.00	X	268	O	O	X	X	X
22	0h1316	Dec Dwell Freq	Deceleration dwell frequency	Starting frequency -maximum frequency (Hz)	5.00	X	268	O	O	X	X	X
23	0h1317	Dec Dwell Time	Deceleration dwell operation time	0-60.0 (sec)	0.00	X	268	O	O	X	X	X

* The grey cells indicate a hidden code which is only visible when setting a code.

Note 8) ADV-12 is displayed only when ADV-07 "Stop Mode" is set as "DC-Start".

Note 9) ADV-14-17 is displayed only when ADV-08 "Stop Mode" is set as "DC-Brake".

Table of Functions

Expansion Function Group (PAR → ADV)

No.	Communication Address	LCD Display	Name	Setting Range	Initial Value	Shift in Operation	Page	Control Mode				
								V / F	S / L	V / C	S / L / T	
24	0h1318	Freq Limit	Frequency limit	0 No 1 Yes	0:No	X	187	O	O	O	X	X
25 Note 10)	0h1319	Freq Limit Lo	Frequency lower limit	0–upper limit (Hz)	0.50	O	187	O	O	O	X	X
26	0h131A	Freq Limit Hi	Frequency upper limit	0.5–maximum frequency (Hz)	60.00	X	187	O	O	O	X	X
27	0h131B	Jump Freq	Frequency jump	0 No 1 Yes	0:No	X	189	O	O	O	X	X
28 Note 11)	0h131C	Jump Lo 1	Jump frequency lower limit 1	0–jump frequency upper limit 1 (Hz)	10.00	O	189	O	O	O	X	X
29	0h131D	Jump Hi 1	Jump frequency upper limit 1	Jump frequency lower limit 1–maximum frequency (Hz)	15.00	O	189	O	O	O	X	X
30	0h131E	Jump Lo 2	Jump frequency lower limit 2	0–jump frequency upper limit 2 (Hz)	20.00	O	189	O	O	O	X	X
31	0h131F	Jump Hi 2	Jump frequency upper limit 2	Jump frequency lower limit 2–maximum frequency (Hz)	25.00	O	189	O	O	O	X	X
32	0h1320	Jump Lo 3	Jump frequency lower limit 3	0–jump frequency upper limit 3 (Hz)	30.00	O	189	O	O	O	X	X
33	0h1321	Jump Hi 3	Jump frequency upper limit 3	Jump frequency lower limit 3–maximum frequency (Hz)	35.00	O	189	O	O	O	X	X
34 Note 10)	0h1322	Jog Freq Limit	Jog frequency limit	0 No 1 Yes	1:Yes	O	187	O	O	O	X	X
41 Note 12)	0h1329	BR Rls Curr	Brake release current	0–180.0 (%)	50.0	O	268	O	O	O	X	X
42	0h132A	BR Rls Dly	Brake release delay time	0–10.00 (sec)	1.00	X	268	O	O	O	X	X
44	0h132C	BR Rls Fwd Fr	Brake release forward frequency	0–400 (Hz)	1.00	X	268	O	O	O	X	X
45	0h132D	BR Rls Rev Fr	Brake release reverse frequency	0–400 (Hz)	1.00	X	268	O	O	O	X	X
46	0h132E	BR Eng Dly	Brake engage delay time	0–10 (sec)	1.00	X	268	O	O	O	X	X
47	0h132F	BR Eng Fr	Brake engage frequency	0–400 (Hz)	2.00	X	268	O	O	O	X	X
50	0h1332	E-Save Mode	Energy saving operation	0 None 1 Manual 2 Auto	0:None	X	242	O	O	X	X	X
51 Note 13)	0h1333	Energy Save	Energy saving amount	0–30 (%)	0	O	242	O	O	O	X	X
60	0h133C	Xcel Change Fr	Acc/dec time transition frequency	0–maximum frequency (Hz)	0.00	X	169	O	O	O	X	X

* The grey cells indicate a hidden code which is only visible when setting a code.

Note 10) ADV-25–26, 34 is displayed only when ADV-24 (Freq Limit) is set as “Freq Limit”.

Note 11) ADV-28–33 is displayed only when ADV-27 (Jump Freq) is set as “Yes”.

Note 12) ADV-41–47 is displayed only when a code of OUT-31–33 is set as “BR Control”.

Note 13) ADV-51 is displayed only when ADV-50 (E-Save Mode) is set as a value other than “None”.

Expansion Function Group (PAR → ADV)

No.	Communication Address	LCD Display	Name	Setting Range	Initial Value	Shift in Operation	Page	Control Mode							
								V / F	S L	V C	S L T	V C T			
61	-	Load Spd Gain	Revolution display gain	0.1-6000.0 (%)	100.0	O	287	O	O	O	X	X			
62	-	Load Spd Scale	Revolution display scale	0	x 1	0:x 1	O	287	O	O	O	X	X		
				1	x 0.1										
				2	x 0.01										
				3	x 0.001										
				4	x 0.0001										
63	0h133F	Load Spd Unit	Revolution display unit	0 Rpm 1 Mpm	0:rpm	O	287	O	O	O	O	O			
64	0h1340	FAN Control	Cooling fan control	0	During Run	0:During Run	O	254	O	O	O	X	X		
				1	Always ON										
				2	Temp Control										
65	0h1341	U/D Save Mode	Up/down operation frequency save	0	No	0:No	O	202	O	O	O	X	X		
				1	Yes										
66	0h1342	On/Off Ctrl Src	Output contact On/Off control options	0	None	0:None	X	269	O	O	O	O	O	O	O
				1	V1										
				2	I1										
				3	V2										
				4	I2										
67	0h1343	On-C Level	Output contact point On level	10-100 (%)	90.00	X	269	O	O	O	O	O			
68	0h1344	Off-C Level	Output contact point Off level	-100.00-output contact point On level (%)	10.00	X	269	O	O	O	O	O			
70	0h1346	Run En Mode	Safe operation selection	0 Always Enable 1 DI Dependent	0:Always Enable	X	207	O	O	O	O	O			
71 <small>Note14)</small>	0h1347	Run Dis Stop	Safe operation stop method	0	Free-Run	0:Free-Run	X	207	O	O	O	O	O	O	
				1	Q-Stop										
				2	Q-Stop Resume										
72	0h1348	Q-Stop Time	Safe operation deceleration time	0-600.0 (sec)	5.0	O	207	O	O	O	O	O			
73	0h1349	RegenAvd Mode	Regeneration evasion mode	Bit	001-111	001	X	278	O	O	O	O	O	O	O
				0	Steady										
				1	Accelerating										
				2	Decelerating										
74	0h134A	RegenAvd Sel	Selection of regeneration evasion function for press	0	No	No	X	278	O	O	O	O	O	O	
				1	Yes										
75	0h134B	RegenAvd Level	Operational voltage level of regeneration evasion motion for press	200 V: 300-400	350 V	350 V	X	278	O	O	O	X	X		
				400 V: 600-800	700 V										
76 <small>Note15)</small>	0h134C	CompFreq Limit	Compensation frequency limit of regeneration for evasion for press	0-10.00 Hz	1.00 (Hz)	X	278	O	O	O	X	X			
77	0h134D	RegenAvd Pgain	Regeneration evasion for press P gain	0-100.0 %	50.0 (%)	O	278	O	O	O	X	X			

Function Table

Table of Functions

No.	Communi- cation Address	LCD Display	Name	Setting Range	Initial Value	Shift in Opera- tion	Page	Control Mode					
								V / F	S / L	V / C	S / L T	V / C T	
78	0h134E	RegenAvd lgain	Regeneration evasion for press I gain	20~30000 (ms)	500 (ms)	O	278	O	O	O	X	X	X
79	0h134F	DB Turn On Lev	DB unit operating voltage	200 V : 350~400 (V) 400 V : 600~800 (V)	390 (V) 780 (V)	X	282	O	O	O	O	O	O
80	0h1350	Fire Mode Sel	Select fire mode	0 None 1 Fire Mode 2 Fire Test	0:None	X	280	O	O	O	X	X	X
81 Note16)	0h1351	Fire Mode Freq	Fire mode frequency	0-maximum frequency (Hz)	60.00	X	280	O	O	O	X	X	X
82	0h1352	Fireq Mode Dir	Fire mode operating direction	0 Forward 1 Reverse	0:Forwar d	X	280	O	O	O	X	X	X
83	-	Fire Mode Cnt	Fire mode counter	0-99	0	X	280	O	O	O	X	X	X
85	0h1355	U/D Mode Sel	U/D Mode	0 U/D Normal 1 U/D Step 2 U/D Step+Norm	0:U/D Normal	X	202	O	O	O	X	X	X
86 Note17)	0h1356	U/D Step Freq	U/D step frequency	0-maximum frequency [Hz]	0.00	O	202	O	O	O	X	X	X
87	0h1357	OVM Mode Sel	Voltage Drop compensation	0 No 1 Yes	0:No	X	298	O	X	O	O	O	O
91	0h135B	Auxiliary OPT Sel	AUX Power Option Sel	0 No 1 Yes	0:No	X	-	O	O	O	O	O	O
92 Note18)	0h135C	SlipGain Mot- H	slip compensation offsetting gain H	0~200[%]	50	O	210	O	X	X	X	X	X
93	0h135D	SlipGain Gen- H	slip compensation regenerative gain H	0~200[%]	50	O	210	O	X	X	X	X	X
94	0h135E	SlipGain Mot- L	slip compensation offsetting gain L	0~200[%]	50	O	210	O	X	X	X	X	X
95	0h135F	SlipGain Gen- L	slip compensation regenerative gain L	0~200[%]	50	O	210	O	X	X	X	X	X
96	0h1360	Slip Filter	slip compensation filter	0~10000[msec]	300	O	210	O	X	X	X	X	X
97	0h1361	Slip Comp Freq	slip compensation frequency	0~60.00[Hz]	5.00	O	210	O	X	X	X	X	X
98	0h1362	Slip Gain Freq	slip compensation gain switchover frequency	0~20.00[Hz]	9.00	O	210	O	X	X	X	X	X

* The grey cells indicate a hidden code which is only visible when setting a code.

Note 14) ADV-71~72 is displayed only when ADV-70 (Run En Mode) is set as "DI Dependent".

ADV-73 is displayed only when ADV-74 (RegenAvd Sel) is set as "Yes".

Note 15) ADV-76~78 is displayed only when ADV-75 (RegenAvd Sel) is set as "Yes".

Note 16) ADV-81~83 displayed only when ADV-80 (Fire Mode Sel) is set as "Fire Mode" or "Fire Test".

Note 17) ADV-86 is displayed when ADV-85 (U/D Mode Sel) is not set to "U/D Normal".

Note 18) ADV-92~98 is displayed only when DRV-09 (Control Mode) is set as "Slip Compen"

13.4 Parameter Mode – Control Function Group (→CON)

Control Function Group (PAR → CON)

No.	Communication Address	LCD Display	Name	Setting Range	Initial Value	Shift in Operation	Page	Control Mode					
								V / F	S / L	V / C	S / L	V / C / T	
00	-	Jump Code	Jump code	0-99	51	O		O	O	O	O	O	
04	0h1404	Carrier Freq	Carrier frequency	Below 22 kW	0.7–15 (kHz)	5.0	O	248	O	O	O	O	
				30–45 kW	0.7–10 (kHz)	5.0							
				55–75 kW	0.7–7 (kHz)	5.0							
				90–110 kW	0.7–6 (kHz)	3.0							
				132–160 kW	0.7–5 (kHz)	3.0							
				185–220 kW	0.7–3 (kHz)	2.0							
280–375 kW	0.7–2 (kHz)	2.0											
05	0h1405	PWM Mode	Switching mode	0 Normal PWM 1 Low leakage PWM	0:Normal PWM	X	248	O	O	O	O	O	
09	0h1409	PreExTime	Initial excitation time	0–60 (sec)	1.00	X	232	X	X	O	O	O	
10	0h140A	Flux Force	Initial excitation power supply	100–500 (%)	100.0	X	232	X	X	O	O	O	
11	0h140B	Hold Time	Continued operation duration	0–60 (sec)	Dependent on control mode	X	232	X	X	O	X	X	
12	0h140C	ASR P Gain 1	Speed controller proportional gain 1	10–500 (%)	50.0	O	232	X	X	O	X	X	
13	0h140D	ASR I Gain 1	Speed controller integral gain 1	10–9999 (msec)	300	O	232	X	X	O	X	X	
15	0h140F	ASR P Gain 2	Speed controller proportional gain 2	10–500 (%)	50.0	O	232	X	X	O	X	X	
16	0h1410	ASR I Gain 2	Speed controller integral gain 2	10–9999 (ms)	300	O	232	X	X	O	X	X	
18	0h1412	Gain SW Freq	Gain exchange frequency	0–120 (Hz)	0.00	X	232	X	X	O	X	X	
19	0h1413	Gain Sw Delay	Gain exchange time	0–100 (sec)	0.10	X	232	X	X	O	X	X	
20	0h1414	SL2 G View Sel	Sensorless 2nd gain display setting	0	No	0:No	O	228	X	X	X	X	X
				1	Yes								
21	0h1415	ASR-SL P Gain1	Sensorless speed controller proportional gain 1	0–5000 (%)	Dependent on motor capacity	O	228	X	O	X	X	X	
22	0h1416	ASR-SL I Gain1	Sensorless speed controller integral gain 1	10–9999 (ms)	Dependent on motor capacity	O	228	X	O	X	X	X	
23 Note17)	0h1417	ASR-SL P Gain2	Senseless speed controller proportional gain 2	1.0–1000.0 (%)	Dependent on motor capacity	O	228	X	X	X	X	X	
24	0h1418	ASR-SL I	Sensorless2	1.0–1000.0 (%)	Dependent	O	228	X	X	X	X	X	

Function Table

Table of Functions

No.	Communi- cation Address	LCD Display	Name	Setting Range	Initial Value	Shift in Opera- tion	Page	Control Mode					
								V / F	S L	V C	S L T	V C T	
		Gain2	speed controller integral gain 2		on motor capacity								
26	0h141A	Observer Gain1	Sensorless2 measurer gain 1	0-30000	10500	O	228	X	X	X	X	X	X
27	0h141B	Observer Gain2	Sensorless2 measurer gain 2	1-1000 (%)	100.0	O	228	X	X	X	X	X	X
28	0h141C	Observer Gain3	Sensorless2 measurer gain 3	0-30000	13000	O	228	X	X	X	X	X	X
29	0h141D	S-Est P Gain1	Sensorless2 speed estimator proportional gain 1	0-30000	Dependent on motor capacity	O	228	X	X	X	X	X	X
30	0h141E	S-Est I Gain1	Sensorless2 speed estimator integral gain 1	0-30000	Dependent on motor capacity	O	228	X	X	X	X	X	X

* The grey cells indicate a hidden code which is only visible when setting a code.

Note 17) CON-23-28, 31-32 are displayed only when DRV-09 (Control Mode) is "Sensorless2" and CON-20 (SL2 G View Sel) is set as "Yes".

Control Function Group (PAR → CON)

No.	Communication Address	LCD Display	Name	Setting Range	Initial Value	Shift in Operation	Page	Control Mode					
								V / F	S L C	S L T	V C T		
31	0h141F	S-Est P Gain2	Sensorless2 speed estimator proportional gain 2	1.0–1000.0 (%)	Dependent on motor capacity	O	228	X	X	X	X	X	
32	0h1420	S-Est I Gain2	Sensorless2 speed estimator integral gain 2	1.0–1000.0 (%)	Dependent on motor capacity	O	228	X	X	X	X	X	
34	0h1422	SL2 OVM Perc	Sensorless2 overvoltage modulation range adjustment	100–180 (%)	120	X	230	X	O	X	X	X	
35	0h1423	SL2 L-ExcitLmt	Magnetic flux current minimum ratio	3~100[%]	10	O	236	X	X	X	O	X	
45 <small>Note 18)</small>	0h142D	PG P Gain	PG operation proportional gain	0–9999	3000	O	225	O	X	X	X	X	
46	0h142E	PG I Gain	PG operation integral gain	0–9999	50	O	225	O	X	X	X	X	
47	0h142F	PG Slip Max%	PG operation maximum slip	0–200	100	X	225	O	X	X	X	X	
48	0h1430	ACR P Gain	Current controller P gain	0–10000	1200	O	228	X	O	O	O	O	
49	0h1431	ACR I Gain	Current controller I gain	0–10000	120	O	228	X	O	O	O	O	
51	0h1433	ASR Ref LPF	Speed controller reference filter	0–20000 (ms)	0	X	232	X	O	O	X	X	
52	0h1434	Torque Out LPF	Torque controller output filter	0–2000 (ms)	0	X	232	X	X	X	O	O	
53	0h1435	Torque Lmt Src	Torque limit setting options	0	Keypad-1	0:Keypad-1	X	232	X	X	X	O	O
				1	Keypad-2								
				2	V1								
				3	I1								
				4	V2								
				5	I2								
				6	Int 485								
				7	Encoder								
				8	FieldBus								
				9	PLC								
				10	Synchro								
11	Binary Type												
54 <small>Note 19)</small>	0h1436	FWD +Trq Lmt	Forward offsetting torque limit	0–200 (%)	180.0	O	232	X	X	X	O	O	
55	0h1437	FWD –Trq Lmt	Forward offsetting torque limit	0–200 (%)	180.0	O	232	X	X	X	O	O	
56	0h1438	REV +Trq Lmt	Reverse regenerative torque limit	0–200 (%)	180.0	O	232	X	X	X	O	O	
57	0h1439	REV –Trq Lmt	Reverse regenerative torque limit	0–200 (%)	180.0	O	232	X	X	X	O	O	

* The grey cells indicate a hidden code which is only visible when setting a code.

Note 18) CON-45–47 are displayed when the Encoder module is installed and Control mode is set as “V/F PG”.

Note 19) CON-54–57 are displayed only when DRV-09 (Control Mode) is set as “Sensorless-1, 2” or “Vector”.

In addition, the initial value of the torque limit is changed to 150% when the ADV-74 RegenAvd Level function is set.

Function Table

Table of Functions

Control Function Group (PAR → CON)

No.	Communi- cation Address	LCD Display	Name	Setting Range	Initial Value	Shift in Opera- tion	Page	1)Control Mode				
								V / F	S L	V C	S L T	V C T
58	0h143A	Trq Bias Src	Torque bias setting options	0 Keypad-1	0:Keypad-1	X	232	X	X	O	X	X
				1 Keypad-2								
				2 V1								
				3 I1								
				4 V2								
				5 I2								
				6 Int 485								
				7 FieldBus								
8 PLC												
59	0h143B	Torque Bias	Torque bias	-120~120 (%)	0.0	O	232	X	X	O	X	X
60	0h143C	Torque Bias FF	Torque bias compensation	0~100 (%)	0.0	O	232	X	X	O	X	X
62	0h143E	Speed Lmt Src	Speed limit setting options	0 Keypad-1	0:Keypad-1	O	236	X	X	X	X	O
				1 Keypad-2								
				2 V1								
				3 I1								
				4 V2								
				5 I2								
				6 Int 485								
				7 FieldBus								
8 PLC												
63	0h143F	FWD Speed Lmt	Forward speed limit	0~maximum frequency (Hz)	60.00	O	236	X	X	X	X	O
64	0h1440	REV Speed Lmt	Reverse speed limit	0~maximum frequency (Hz)	60.00	O	236	X	X	X	X	O
65	0h1441	Speed Lmt Gain	Speed limit operation gain	100~5000 (%)	500	O	236	X	X	X	X	O
66	0h1442	Droop Perc	Droop operation amount	0~100 (%)	0.0	O	238	X	X	X	X	O
67 Note 20)	0h1443	Droop St Trq	Droop start torque	0~100 (%)	100.0	O	238	X	X	X	X	O
68	0h1444	SPD/TRQA c T	Torque mode →speed mode exchange acceleration time	0~600 (sec)	20.0	O	238	X	X	X	X	O
69	0h1445	SPD/TRQA c T	Torque mode →speed mode exchange deceleration time	0~600 (sec)	30.0	O	238	X	X	X	X	O

* The grey cells indicate a hidden code which is only visible when setting a code.

Note 20) CON-67 is displayed only when the Encoder option module is installed.

Control Function Group (PAR → CON)

No.	Communi- cation Address	LCD Display	Name	Setting Range	Initial Value	Shift in Opera- tion	Page	1)Control Mode				
								V / F	S L	V L	S L T	V C T
70	0h1446	SS Mode	Speed search mode selection	0 Flying Start - 1 1 Flying Start - 2	0	X	244	O	O	O	X	X
71	0h1447	Speed Search	Speed search operation selection	Bit 0000-1111	0000	X	244	O	O	O	X	X
				1 Speed search selection on acceleration								
				2 Restart after trips								
				3 Restart after instantaneous interruption								
4 Start immediately after power On												
72 <small>Note21)</small>	0h1448	SS Sup-Current	Speed search standard current	80-200 (%)	Below 75 kW 150 Above 90 kW 100	O	244	O	O	X	X	X
73	0h1449	SS P-Gain	Speed search proportional gain	0-9999	100	O	244	O	O	X	X	X
74	0h144A	SS I-Gain	Speed search integral gain	0-9999	200	O	244	O	O	X	X	X
75	0h144B	SS Block Time	Output block time before speed search	0-60 (sec)	1.0	X	244	O	O	X	X	X
77	0h144D	KEB Select	Energy buffering selection	0 None 1 KEB-1 2 KEB-2	0:None	X	239	O	O	O	X	X
78 <small>Note21)</small>	0h144E	KEB Start Lev	Energy buffering start level	110-200 (%)	130.0	X	239	O	O	O	X	X
79	0h144F	KEB Stop Lev	Energy buffering stop level	130-210 (%)	135.0	X	239	O	O	O	X	X
80	0h1450	KEB Gain	Energy buffering gain	1-2000	1000	O	239	O	O	O	X	X
82 <small>Note22)</small>	0h1452	ZSD Frequency	Permanent detection frequency	0-10 (Hz)	2.00	O	302	X	X	O	X	O
83	0h1453	ZSD Band	Permanent detection frequency band	0-2 (Hz)	1.00	O	302	X	X	O	X	O
86 <small>Note23)</small>	0h1456	KEB P Gain	Energy buffering P gain	0-20000	1500	O	239	O	O	O	X	X
87	0h1457	KEB I Gain	Energy buffering I gain	1-20000	500	O	239	O	O	O	X	X
88	0h1458	KEB Slip Gain	Energy buffering slip gain	0-2000.0 (%)	30.0	O	239	O	O	O	X	X
89	0h1459	KEB Acc Time	Energy buffering acceleration time	0-600 (sec)	10.0	O	239	O	O	O	X	X
90	0h145A	New AHR Sel	Select function for preventing current hunting	0 No	0:No	O	279	O	X	X	X	X
				1 Yes								
91	0h145B	AHR P-Gain	Gain from current	0-32767	1000	X	279	O	X	X	X	X

Function Table

Table of Functions

No.	Communication Address	LCD Display	Name	Setting Range	Initial Value	Shift in Operation	Page	1) Control Mode					
								V / F	S / L	V / C	S / L / T		
			hunting prevention										

* The grey cells indicate a hidden code which is only visible when setting a code.

Note 21) CON-72-75 are displayed only when CON-71,77 is set as a bit or other than "None".

Note 22) CON-82-83 are displayed only when DRV-09 (Control Mode) is set as "Vector".

Note 23) CON-78-79,86-89 are displayed only when CON-77 (KEB Select) is set as "KEB-1" or "KEB-2"

Note 24) CON-91 is displayed only when CON-90 (New AHR Sel) is set as "Yes".

13.5 Parameter Mode – Input Terminal Block Function Group (→IN)

Input Terminal Block Function Group (PAR → IN)

No.	Communication Address	LCD Display	Name	Setting Range	Initial Value	Shift in Operation	Page	Control Mode					
								V / F	S / L	V / L	S / T	V / L	S / T
00	-	Jump Code	Jump code	0-99	65	O	-	O	O	O	O	O	O
01	0h1501	Freq at 100%	Frequency at maximum analog input	Start frequency-maximum frequency (Hz)	60.00	O	139	O	O	O	X	X	X
02	0h1502	Torque at 100%	Torque at maximum analog input	0-200 (%)	100.0	O	139	X	X	O	O	O	O
05	0h1505	V1 Monitor(V)	V1 input voltage display	0-10 (V)	0.00	O	139	O	O	O	O	O	O
06	0h1506	V1 Polarity	V1 input polarity selection	0 Unipolar 1 Bipolar	0: Unipolar Unipolar	O	139	O	O	O	O	O	O
07	0h1507	V1 Filter	V1 input filter time constant	0-10000 (ms)	10	O	139	O	O	O	O	O	O
08	0h1508	V1 Volt x1	V1 minimum input voltage	0-10 (V)	0.00	O	139	O	O	O	O	O	O
09	0h1509	V1 Perc y1	V1 minimum output voltage (%)	0-100 (%)	0.00	O	139	O	O	O	O	O	O
10	0h150A	V1 Volt x2	V1 maximum input voltage	0-10 (V)	10.00	O	139	O	O	O	O	O	O
11	0h150B	V1 Perc y2	V1 maximum output voltage (%)	0-100 (%)	100.00	O	139	O	O	O	O	O	O
12 Note 24)	0h150C	V1 (-)Volt x1'	V1 (-) minimum input voltage	-10-0 (V)	0.00	O	143	O	O	O	O	O	O
13	0h150D	V1 (-)Perc y1'	V1 (-) minimum output voltage (%)	-100-0 (%)	0.00	O	143	O	O	O	O	O	O
14	0h150E	V1 (-)Volt x2'	V1 (-) maximum input voltage	-10-0 (V)	-10.00	O	143	O	O	O	O	O	O
15	0h150F	V1 (-)Perc y2'	V1 (-) maximum output voltage (%)	-100-0 (%)	-100.00	O	143	O	O	O	O	O	O
16	0h1510	V1 Inverting	Rotation direction change	0 No 1 Yes	0: No	O	139	O	O	O	O	O	O
17	0h1511	V1 Quantizing	V1 quantization change	0.04-10 (%)	0.04	O	139	O	O	O	O	O	O
20	0h1514	I1 Monitor(mA)	I1 input display	0-20 (mA)	0.00	O	146	O	O	O	O	O	O
22	0h1516	I1 Filter	I1 input filter time constant	0-10000 (ms)	10	O	146	O	O	O	O	O	O
23	0h1517	I1 Curr x1	I1 minimum input current	0-20 (mA)	4.00	O	146	O	O	O	O	O	O
24	0h1518	I1 Perc y1	Output at I1 minimum current (%)	0-100 (%)	0.00	O	146	O	O	O	O	O	O
25	0h1519	I1 Curr x2	I1 maximum input current	4-20 (mA)	20.00	O	146	O	O	O	O	O	O
26	0h151A	I1 Perc y2	Output at I1 maximum current	0-100 (%)	100.00	O	146	O	O	O	O	O	O
31	0h151F	I1 Inverting	Rotation direction change	0 No 1 Yes	0: No	O	146	O	O	O	O	O	O
32	0h1520	I1 Quantizing	I1 quantization level	0.04-10 (%)	0.04	O	146	O	O	O	O	O	O

Note 24) IN-12-15 codes are displayed only when IN-06 (V1 Polarity) is set as "Bipolar".

Table of Functions

Input Terminal Block Function Group (PAR → IN)

No.	Communi- cation Address	LCD Display	Name	Setting Range	Initial Value	Shift in Opera- tion	Page	Control Mode				
								V / F	S L	V C	S L T	V C T
35 <small>Note 25)</small>	0h1523	V2 Monitor(V)	V2 input display	0-10 (V)	0.00	O	148	O	O	O	O	O
36	0h1524	V2 Polarity	V1 input polarity selection	0 Unipolar 1 Bipolar	1: Bipolar	O	148	O	O	O	O	O
37	0h1525	V2 Filter	V2 input filter time constant	0-10000 (ms)	10	O	148	O	O	O	O	O
38	0h1526	V2 Volt x1	V2 minimum input voltage	0-10 (V)	0.00	O	148	O	O	O	O	O
39	0h1527	V2 Perc y1	Output at V2 minimum voltage (%)	0-100 (%)	0.00	O	148	O	O	O	O	O
40	0h1528	V2 Volt x2	V2 maximum input voltage	0-10 (V)	10.00	O	148	O	O	O	O	O
41	0h1529	V2 Perc y2	Output at V2 maximum voltage (%)	0-100 (%)	100.00	O	148	O	O	O	O	O
42	0h152A	V2 -Volt x1'	V2 -minimum input voltage	-10-0 (V)	0.00	O	148	O	O	O	O	O
43	0h152B	V2 -Perc y1'	Output at V2 -minimum voltage (%)	-100-0 (%)	0.00	O	148	O	O	O	O	O
44	0h152C	V2 -Volt x2'	V2 -maximum input voltage	-10-0 (V)	-10.00	O	148	O	O	O	O	O
45	0h152D	V2 -Perc y2'	Output at V2 -maximum voltage (%)	-100-0 (%)	-100.00	O	148	O	O	O	O	O
46	0h152E	V2 Inverting	Rotation direction change	0 No 1 Yes	0:No	O	148	O	O	O	O	O
47	0h152F	V2 Quantizing	V2 quantization level	0.04-10 (%)	0.04	O	148	O	O	O	O	O
50	0h1532	I2 Monitor(mA)	I2 input display	0-20 (mA)	0.00	O	149	O	O	O	O	O
52	0h1534	I2 Filter	I2 input filter time constant	0-10000 (ms)	15	O	149	O	O	O	O	O
53	0h1535	I2 Curr x1	I2 minimum input current	0-20 (mA)	4.00	O	149	O	O	O	O	O
54	0h1536	I2 Perc y1	Output at I2 minimum current (%)	0-100 (%)	0.00	O	149	O	O	O	O	O
55	0h1537	I2 Curr x2	I2 maximum input current	0-20 (mA)	20.00	O	149	O	O	O	O	O
56	0h1538	I2 Perc y2	Output at I2 maximum current (%)	0-100 (%)	100.00	O	149	O	O	O	O	O
61	0h153D	I2 Inverting	Rotation direction change	0 No 1 Yes	0:No	O	149	O	O	O	O	O
62	0h153F	I2 Quantizing	I2 quantization level	0.04-10 (%)	0.04	O	149	O	O	O	O	O

* The grey cells indicate a hidden code which is only visible when setting a code.

Note 25) IN-35-62 codes are displayed only when the expansion IO module is installed.

Input Terminal Block Function Group (PAR → IN)

No.	Communication Address	LCD Display	Name	Setting Range	Initial Value	Shift in Operation	Page	Control Mode					
								V / F	S L	V C	S L T	V C T	
65	0h1541	P1 Define	P1 terminal function setting	0	NONE	1:FX	X	158	O	O	O	O	O
				1	FX								
66	0h1542	P2 Define	P2 terminal function setting	2	RX	2:RX	X	158	X	X	O	O	O
				3	RST	5:BX	X	329	O	O	O	O	
68	0h1544	P4 Define	P4 terminal function setting	4	External Trip	3:RST	X	318	O	O	O	O	
69	0h1545	P5 Define	P5 terminal function setting	5	BX	7:Sp-L	X	328	O	O	O	O	
70	0h1546	P6 Define	P6 terminal function setting	6	JOG	8:Sp-M	X	199	O	O	O	O	
71	0h1547	P7 Define	P7 terminal function setting	7	Speed-L	9:Sp-H	X	154	O	O	O	O	
72	0h1548	P8 Define	P8 terminal function setting	8	Speed-M	6:JOG	X	154	O	O	O	O	
73 <small>Note26)</small>	0h1549	P9 Define	P9 terminal function setting	9	Speed-H	0:NONE	X	154	O	O	O	O	
74	0h154A	P10 Define	P10 terminal function setting	10	Speed-X	0:NONE	X	154	O	O	O	O	
75	0h154B	P11 Define	P11 terminal function setting	11	XCEL-L	0:NONE	X	168					
				12	XCEL-M			168					
				13	RUN Enable			207					
				14	3-Wire			206					
				15	2nd Source			190					
				16	Exchange			253					
				17	Up			202					
				18	Down			202					
				19	U/D Save			202					
				20	U/D Clear			202					
				21	Analog Hold			153					
				22	I-Term Clear			210					
				23	PID Openloop			210					
				24	P Gain2			210					
				25	XCEL Stop			173					
26	2nd Motor			251									
27	Trv Offset Lo			266									
28	Trv Offset Hi			266									
29	Interlock 1			275									
30	Interlock 2			275									
31	Interlock 3			275									
32	Interlock 4			275									

Function Table

*  The grey cells indicate a hidden code which is only visible when setting a code.

Note 26) IN73-75 codes are displayed only when the expansion IO module is installed.

Table of Functions

Input Terminal Block Function Group (PAR → IN)

No.	Communication Address	LCD Display	Name	Setting Range	Initial Value	Shift in Operation	Page	Control Mode					
								V / F	S / L	V / C	S / T		
				33 -Reserved-			-						
				34 Pre Excite			-						
				35 Speed/Torque			236						
				36 ASR Gain 2			233						
				37 ASR P/PI			233						
				38 Timer In			265						
				39 Thermal In			315						
				40 Dis Aux Ref			194						
				41 -Reserved-			-						
				42 -Reserved-			-						
				43 -Reserved-			-						
				44 -Reserved-			-						
				45 -Reserved-			-						
				46 FWD JOG			200						
				47 REV JOG			200						
				48 Trq Bias			235						
				49 XCEL-H			168						
				50 KEB Select			239						
				51 Fire Mode			280						
85	0h1555	DI On Delay	Multi-function input terminal On filter	0-10000 (ms)	10	O	192	O	O	O	O	O	O
86	0h1556	DI Off Delay	Multi-function input terminal Off filter	0-10000 (ms)	3	O	192	O	O	O	O	O	O
87	0h1557	DINC/NO Sel	Multi-function input contact point selection	P8 - P1 0 A contact point (NO) 1 B contact point (NC)	0000 0000	X	192	O	O	O	O	O	O
88	0h1558	RunOn Delay	Operating command delay time	0-100 (sec)	0.00	X	192	O	O	O	O	O	O
89	0h1559	InCheck Time	Sequential command delay time	1-5000 (ms)	1	X	192	O	O	O	O	O	O
90	0h155A	DI Status	Multi-function input terminal status	P8 - P1 0 Open (Off) 1 Connection (On)	0000 0000	O	192	O	O	O	O	O	O

13.6 Parameter Mode – Output Terminal Block Function Group (→OUT)

Output Terminal Block Function Group (PAR → OUT)

No.	Communi- cation Address	LCD Display	Name	Setting Range	Initial Value	Shift in Opera- tion	Page	Control Mode				
								V / F	S L C	V L C	S L T	
00	-	JumpCode	Jump code	0-99	30	O	-	O	O	O	O	O
01	0h1601	AO1 Mode	Analog output 1	0	Frequency	0: Frequency	O	291	O	O	O	O
				1	Current							
				2	Voltage							
				3	DC Link Volt							
				4	Torque							
				5	Watt							
				6	Idss							
				7	Iqss							
				8	Target Freq							
				9	Ramp Freq							
				10	Speed Fdb							
				11	Speed Dev							
				12	PIDRef Value							
				13	PIDFdb Value							
				14	PID Output							
15	Constant											
02	0h1602	AO1 Gain	Analog output1 gain	-1000~1000(%)	100.0	O	291	O	O	O	O	O
03	0h1603	AO1 Bias	Analog output 1 bias	-100~100(%)	0.0	O	291	O	O	O	O	O
04	0h1604	AO1 Filter	Analog output1 filter	0~10000 (ms)	5	O	291	O	O	O	O	O
05	0h1605	AO1 Const %	Analog constant output 1	0~1000(%)	0.0	O	291	O	O	O	O	O
06	0h1606	AO1 Monitor	Analog output 1 monitor	0~1000(%)	0.0	-	291	O	O	O	O	O
07	0h1607	AO2 Mode	Analog output 2 item	0	Frequency	0: Frequency	O	293	O	O	O	O
				1	Current							
				2	Voltage							
				3	DC Link Volt							
				4	Torque							
				5	Watt							
				6	Idss							
				7	Iqss							
				8	Target Freq							
				9	Ramp Freq							
				10	Speed Fdb							
				11	Speed Dev							
				12	PIDRef Value							
				13	PIDFbk Value							
				14	PID Output							
15	Constant											

Function
Table

Table of Functions

Output Terminal Block Function Group (PAR → OUT)

No.	Communication Address	LCD Display	Name	Setting Range	Initial Value	Shift in Operation	Page	Control Mode					
								V / F	S / L	V / C	S / T		
08	0h1608	AO2 Gain	Analog output 2 gain	-1000~1000 (%)	80.0	O	293	O	O	O	O	O	
09	0h1609	AO2 Bias	Analog output 2 bias	-100~100 (%)	20.0	O	293	O	O	O	O	O	
10	0h160A	AO2 Filter	Analog output 2 filter	0~10000 (ms)	5	O	293	O	O	O	O	O	
11	0h160B	AO2 Const %	Analog constant output 2	0~100 (%)	0.0	O	293	O	O	O	O	O	
12	0h160C	AO2 Monitor	Analog output 2 monitor	0~1000 (%)	0.0	O	293	O	O	O	O	O	
14 Note27)	0h160E	AO3 Mode	Analog output 3 item	0	Frequency	0: Frequency	O	296	O	O	O	O	O
				1	Current								
				2	Voltage								
				3	DC Link Volt								
				4	Torque								
				5	Watt								
				6	Idss								
				7	Iqss								
				8	Target Freq								
				9	Ramp Freq								
				10	Speed Fdb								
				11	Speed Dev								
				12	PID Ref Value								
				13	PID Fbk Value								
				14	PID Output								
				15	Constant								
15	0h160F	AO3 Gain	Analog output 3 gain	-1000~1000 (%)	100.0	O	296	O	O	O	O	O	
16	0h1610	AO3 Bias	Analog output 3 bias	-100~100 (%)	0.0	O	296	O	O	O	O	O	
17	0h1611	AO3 Filter	Analog output 3 filter	0~10000 (ms)	5	O	296	O	O	O	O	O	
18	-	AO3 Const %	Analog constant output 3	0~100 (%)	0.0	O	296	O	O	O	O	O	
19	0h1613	AO3 Monitor	Analog output 3 monitor	-1000~1000 (%)	0.0	O	296	O	O	O	O	O	
20	0h1614	AO4 Mode	Analog output 4 item	0	Frequency	0: Frequency		297	O	O	O	O	O
				1	Current								
				2	Voltage								
				3	DC Link Volt								
				4	Torque								
				5	Watt								
				6	Idss								
				7	Iqss								
				8	Target Freq								
				9	Ramp Freq								
				10	Speed Fdb								
				11	Speed Dev								
				12	PID Ref Value								
				13	PID Fbk Value								
				14	PID Output								
				15	Constant								

Output Terminal Block Function Group (PAR → OUT)

No.	Communication Address	LCD Display	Name	Setting Range	Initial Value	Shift in Operation	Page	Control Mode				
								V / F	S / L	V / C	S / T	V / C
21	0h1615	AO4 Gain	Analog output 4 gain	-1000~1000 (%)	80.0	-	297	O	O	O	O	O
22	0h1616	AO4 Bias	Analog output 4 bias	-100~100 (%)	20.0	O	297	O	O	O	O	O
23	0h1617	AO4 Filter	Analog output 4 filter	0~10000 (ms)	5	O	297	O	O	O	O	O
24	-	AO4 Const %	Analog constant output 4	0~100 (%)	0.0	O	297	O	O	O	O	O
25	0h1619	AO4 Monitor	Analog output 4 monitor	0~1000 (%)	0.0	O	297	O	O	O	O	O
30	0h161E	Trip Out Mode	Failure output item	Bit 000 - 111	010	O	298	O	O	O	O	O
				1 Low voltage								
				2 Failure other than low voltage								
				3 Final failure of automatic restart								
31	0h161F	Relay 1	Multi-function relay 1	0 NONE	29:Trip	O	298	O	O	O	O	O
32	0h1620	Relay 2	Multi-function relay 2	1 FDT-1	14:Run	O	298	O	O	O	O	O
33	0h1621	Q1 Define	Multi-function output 1	2 FDT-2	1:FDT-1	O	298	O	O	O	O	O
34 <small>Note 28)</small>	0h1622	Relay 3	Multi-function relay 3	3 FDT-3	2:FDT-2	O	298	O	O	O	O	O
35	0h1623	Relay 4	Multi-function relay 4	4 FDT-4	3:FDT-3	O	298	O	O	O	O	O
36	0h1624	Relay 5	Multi-function relay 5	5 Over Load	4:FDT-4	O	298	O	O	O	O	O
				6 IOL								
				7 Under Load								
				8 Fan Warning								
				9 Stall								
				10 Over Voltage								
				11 Low Voltage								
				12 Over Heat								
				13 Lost Command								
				14 Run								
				15 Stop								
				16 Steady								
				17 Inverter Line								
				18 Comm Line								
				19 Speed Search								
				20 -Reserved-								
				21 -Reserved-								
				22 Ready								
				23 Trv Acc								
				24 Trv Dec								
				25 MMC								
				26 Zspd Dect								
				27 Torque Dect								
				28 Timer Out								

Function Table

Note 27) OUT 14-25 codes are displayed only when the expansion IO module is installed.

Note 28) OUT 34-36 codes are displayed only when the expansion IO module is installed.

Table of Functions

Output Terminal Block Function Group (PAR → OUT)

No.	Communication Address	LCD Display	Name	Setting Range	Initial Value	Shift in Operation	Page	Control Mode					
								V / F	S / L	V / C	S / L / T		
				29 Trip									
				30 Lost Keypad									
				31 DB Warn %ED									
				32 ENC Tune									
				33 ENC Dir									
				34 On/Off Control									
				35 BR Control									
				36 KEB Operating									
				37 Fire Mode									
				38 Run2									
41	0h1629	DO Status	Multi-function output monitoring	-	000	X	298	-	-	-	-	-	-
50	0h1632	DO On Delay	Multi-function output On delay	0-100 (sec)	0.00	O	305	O	O	O	O	O	O
51	0h1633	DO Off Delay	Multi-function output Off delay	0-100 (sec)	0.00	O	305	O	O	O	O	O	O
52	0h1634	DO NC/NO Sel	Multi-function output contact point selection	Q1,Relay2,Relay1	000	X	305	O	O	O	O	O	O
				0 A contact point (NO)									
				1 B contact point (NC)									
53	0h1635	TripOut OnDly	Failure output On delay	0-100 (sec)	0.00	O	304	O	O	O	O	O	O
54	0h1636	TripOut OffDly	Failure output Off delay	0-100.00 (sec)	0.00	O	304	O	O	O	O	O	O
55	0h1637	TimerOn Delay	Timer On delay	0-100.00 (sec)	0.00	O	265	O	O	O	O	O	O
56	0h1638	TimerOff Delay	Timer Off delay	0-100.00 (sec)	0.00	O	265	O	O	O	O	O	O
57	0h1639	FDT Frequency	Detected frequency	0-maximum frequency (Hz)	30.00	O	299	O	O	O	O	O	O
58	0h163A	FDT Band	Detected frequency width	0-maximum frequency (Hz)	10.00	O	299	O	O	O	O	O	O
59	0h163B	TD Level	Detected torque amount	0-150 (%)	100	O	236	X	X	O	X	X	O
60	0h163C	TD Band	Detected torque width	0-10 (%)	5.0	O	236	X	X	O	X	X	O

* The grey cells indicate a hidden code which is only visible when setting a code.

13.7 Parameter Mode – Communication Function Group (→COM)

Communication Function Group (PAR → COM)

No.	Communication Address	LCD Display	Name	Setting Range	Initial Value	Shift in Operation	Page	Control Mode				
								V / F	S / L	V / L	S / T	V / C
00	-	Jump Code	Jump code	0-99	20	O	-	O	O	O	O	O
01	0h1701	Int485 St ID	Built-in communication inverter ID	1-250	1	O	337	O	O	O	O	O
02	0h1702	Int485 Proto	Built-in communication protocol	0 ModBus RTU	0: ModBus RTU	O	337	O	O	O	O	O
				1 --Reserved--								
				2 Serial Debug								
03	0h1703	Int485 BaudR	Built-in communication speed	0 1200 bps	3: 9600 bps	O	337	O	O	O	O	O
				1 2400 bps								
				2 4800 bps								
				3 9600 bps								
				4 19200 bps								
				5 38400 bps								
04	0h1704	Int485 Mode	Built-in communication frame setting	0 D8/PN/S1	0: D8/PN/S1	-	337	O	O	O	O	O
				1 D8/PN/S2								
				2 D8/PE/S1								
				3 D8/PO/S1								
05	0h1705	Resp Delay	Transmission delay after reception	0-1000 (ms)	5 ms	O	337	O	O	O	O	O
06 <small>Note 29-1)</small>	0h1706	FBUS S/W Ver	Communication option S/W version	-	1.00	O	Option	O	O	O	O	O
07	0h1707	FBUS ID	Communication option inverter ID	0-255	1	O	Option	O	O	O	O	O
08	0h1708	FBUS BaudRate	FBUS communication speed	-	12 Mbps		Option	O	O	O	O	O
09	0h1709	FieldBus LED	Communication option LED status	-	-	O	Option	O	O	O	O	O
30	0h171E	ParaStatus Num	Number of output parameters	0-8	3	O	342	O	O	O	O	O
31	0h171F	Para Stauts-1	Output address 1	0000-FFFF Hex	000A	O	342	O	O	O	O	O
32	0h1720	Para Stauts-2	Output address 2	0000-FFFF Hex	000E	O	342	O	O	O	O	O
33	0h1721	Para Stauts-3	Output address 3	0000-FFFF Hex	000F	O	342	O	O	O	O	O
34	0h1722	Para Stauts-4	Output address 4	0000-FFFF Hex	0000	O	342	O	O	O	O	O
35	0h1723	Para Stauts-5	Output address 5	0000-FFFF Hex	0000	O	342	O	O	O	O	O
36	0h1724	Para Stauts-6	Output address 6	0000-FFFF Hex	0000	O	342	O	O	O	O	O
37	0h1725	Para Stauts-7	Output address 7	0000-FFFF Hex	0000	O	342	O	O	O	O	O
38	0h1726	Para Stauts-8	Output address 8	0000-FFFF Hex	0000	O	342	O	O	O	O	O

* The grey cells indicate a hidden code which is only visible when setting a code.

Note 29-1) COM 06-17 codes are displayed only when the communication module is installed.

Refer to the Options manual for options.

Function Table

Communication Function Group (PAR → COM)

No.	Communication Address	LCD Display	Name	Setting Range	Initial Value	Shift in Operation	Page	Control Mode					
								V / F	S	L	V	S	L
50	0h1732	Para Ctrl Num	Number of input parameters	0-8	2	O	342	O	O	O	O	O	O
51	0h1733	Para Control-1	Input address 1	0000-FFFF Hex	0005	X	342	O	O	O	O	O	O
52	0h1734	Para Control-2	Input address 2	0000-FFFF Hex	0006	X	342	O	O	O	O	O	O
53	0h1735	Para Control-3	Input address 3	0000-FFFF Hex	0000	X	342	O	O	O	O	O	O
54	0h1736	Para Control-4	Input address 4	0000-FFFF Hex	0000	X	342	O	O	O	O	O	O
55	0h1737	Para Control-5	Input address 5	0000-FFFF Hex	0000	X	342	O	O	O	O	O	O
56	0h1738	Para Control-6	Input address 6	0000-FFFF Hex	0000	X	342	O	O	O	O	O	O
57	0h1739	Para Control-7	Input address 7	0000-FFFF Hex	0000	X	342	O	O	O	O	O	O
58	0h173A	Para Control-8	Input address 8	0000-FFFF Hex	0000	X	342	O	O	O	O	O	O
68	0h1744	FBus Swap Sel	Profibus swap	0	No	0:No	X	Option	O	O	O	O	O
				1	Yes								
70	0h1746	Virtual DI 1	Communication multi-function input 1	0	None	0:None	O	339	O	O	O	O	O
71	0h1747	Virtual DI 2	Communication multi-function input 2	1	FX	0:None	O	339	O	O	O	O	O
72	0h1748	Virtual DI 3	Communication multi-function input 3	2	RX	0:None	O	339	O	O	O	O	O
73	0h1749	Virtual DI 4	Communication multi-function input 4	3	RST	0:None	O	339	O	O	O	O	O
74	0h174A	Virtual DI 5	Communication multi-function input 5	4	External Trip	0:None	O	339	O	O	O	O	O
75	0h174B	Virtual DI 6	Communication multi-function input 6	5	BX	0:None	O	339	O	O	O	O	O
76	0h174C	Virtual DI 7	Communication multi-function input 7	6	JOG	0:None	O	339	O	O	O	O	O
77	0h174D	Virtual DI 8	Communication multi-function input 8	7	Speed-L	0:None	O	339	O	O	O	O	O
78	0h174E	Virtual DI 9	Communication multi-function input 9	8	Speed-M	0:None	O	339	O	O	O	O	O
79	0h174F	Virtual DI 10	Communication multi-function input 10	9	Speed-H	0:None	O	339	O	O	O	O	O
80	0h1750	Virtual DI 11	Communication multi-function input 11	10	Speed-X	0:None	O	339	O	O	O	O	O
81	0h1751	Virtual DI 12	Communication multi-function input 12	11	XCEL-L	0:None	O	339	O	O	O	O	O
82	0h1752	Virtual DI 13	Communication multi-function input 13	12	XCEL-M	0:None	O	339	O	O	O	O	O
83	0h1753	Virtual DI 14	Communication multi-function input 14	13	RUN Enable	0:None	O	339	O	O	O	O	O
84	0h1754	Virtual DI 15	Communication multi-function input 15	14	3-Wire	0:None	O	339	O	O	O	O	O
85	0h1755	Virtual DI 16	Communication multi-function input 16	15	2nd Source	0:None	O	339	O	O	O	O	O
				16	Exchange								
				17/18	Up/Down								
				19	Reserved								
				20	U/D Clear								
21	Analog Hold												

Table of Functions

No.	Communication Address	LCD Display	Name	Setting Range		Initial Value	Shift in Operation	Page	Control Mode				
									V / F	S L	V C	S L T	
				22	I-Term Clear								
				23	PID Openloop								
				24	P Gain2								
				25	XCEL_Stop								
				26	2nd Motor								
				27	Trv Offset Lo								
				28	Trv Offset Hi								
				29	Interlock 1								
				30	Interlock 2								
				31	Interlock 3								
				32	Interlock 4								
				33	Reserved								
				34	Pre Excite								
				35	Speed/Torque								
				36	ASR Gain 2								
				37	ASR P/PI								
				38	Timer In								
				39	Thermal In								
				40	Dis Aux Ref								
				41	-Reserved-								
				42	-Reserved-								
				43	-Reserved-								
				44	-Reserved-								
				45	-Reserved-								
				46	FWD JOG								
				47	REV JOG								
				48	Trq Bias								
				49	XCEL-H								
				50	KEB Select								
				51	Fire Mode								
86	0h1756	Virt DI Status	Communication multi-function input monitoring	-	-	0	X	339	0	0	0	0	0
90	0h175A	Comm Mon Sel	Monitor type selection	0 1	Int 485 Keypad	0: Int 485	O	341	0	0	0	0	0
91	0h175B	RcvFrame Num	Number of reception frames	-	-	0	-	341	0	0	0	0	0
92	0h175C	Err Frame Num	Number of error frames	-	-	0	-	341	0	0	0	0	0
93	0h175D	Nak Frame Num	Number of writing error frames	-	-	0	-	341	0	0	0	0	0
94 <small>note 29-2)</small>	0h175E	Comm Update	Communication update	0 1	No Yes	0	-	341	0	0	0	0	0

note 29-2) COM 94 is displayed when the communication option module is installed.

Function Table

13.8 Parameter Mode – Applied Function Group (→APP)

Applied Function Group (PAR → APP)

No.	Communication Address	LCD Display	Name	Setting Range	Initial Value	Shift in Operation	Page	Control Mode						
								V / F	S / L	V / C	S / L	V / C		
00	-	Jump Code	Jump code	0-99	20	O	-	O	O	O	O	O	O	
01	0h1801	App Mode	Applied function selection	0 None	0: None	X	-	O	O	O	X	X		
				1 Traverse										
				2 Proc PID										
				3 Reserved										
4 Auto Sequence														
08 Note30)	0h1808	Trv Aprmlt %	Traverse operating range	0-20 (%)	0.0	O	266	O	O	O	X	X		
09	0h1809	Trv Scramb %	Traverse scramble magnitude	0-50 (%)	0.0	O	266	O	O	O	X	X		
10	0h180A	Trv Acc Time	Traverse acceleration time	0.1-600.0 (sec)	2.0	O	266	O	O	O	X	X		
11	0h180B	Trv Dec Time	Traverse deceleration time	0.1-600.0 (sec)	3.0	O	266	O	O	O	X	X		
12	0h180C	Trv Offset Hi	Traverse offset upper limit	0-20.0 (%)	0.0	O	266	O	O	O	X	X		
13	0h180D	Trv Offset Lo	Traverse offset lower limit	0-20.0 (%)	0.0	O	266	O	O	O	X	X		
16 Note31)	0h1810	PID Output	PID output monitor	(%)	0.00	-	213	O	O	O	X	X		
17	0h1811	PID Ref Value	PID reference monitor	(%)	50.00	-	213	O	O	O	X	X		
18	0h1812	PID Fdb Value	PID feedback monitor	(%)	0.00	-	213	O	O	O	X	X		
19	0h1813	PID Ref Set	PID reference setting	-100-100 (%)	50%	O	213	O	O	O	X	X		
20	0h1814	PID Ref Source	PID reference selection	0 Keypad	0:Keypad	X	213	O	O	O	X	X		
				1 V1										
				2 I1										
				3 V2										
				4 I2										
				5 Int 485										
				6 Encoder										
				7 FieldBus										
				8 PLC										
				9 Synchro										
				10 Binary Type										

* The grey cells indicate a hidden code which is only visible when setting a code.

Note 30) APP 08-13 codes are displayed only when APP-01 (App Mode) is set as "Traverse".

Note 31) APP 16-45 codes are displayed only when APP-01 (App Mode) is set as "Proc PID" or APP-01 (App Mode) is set as "MMC" and Reql Bypass (APO-34) is set as "No".

Applied Function Group (PAR → APP)

No.	Communication Address	LCD Display	Name	Setting Range	Initial Value	Shift in Operation	Page	Control Mode				
								V / F	S / L	V / C	S / T	V / T
21	0h1815	PID F/B Source	PID feedback selection	0 V1	0:V1	X	213	O	O	O	X	X
				1 I1								
				2 V2								
				3 I2								
				4 Int 485								
				5 Encoder								
				6 FieldBus								
				7 PLC								
				8 Synchro								
9 Binary Type												
22	0h1816	PID P-Gain	PID proportional gain	0-1000 (%)	50.0	O	213	O	O	O	X	X
23	0h1817	PID I-Time	PID integral time	0-200.0 (sec)	10.0	O	213	O	O	O	X	X
24	0h1818	PID D-Time	PID differential time	0-1000 (ms)	0	O	213	O	O	O	X	X
25	0h1819	PID F-Gain	PID feed forward gain	0-1000.0 (%)	0.0	O	213	O	O	O	X	X
26	0h181A	P Gain Scale	Proportional gain scale	0-100.0 (%)	100.0	X	213	O	O	O	X	X
27	0h181B	PID Out LPF	PID output filter	0-10000 (ms)	0	O	213	O	O	O	X	X
28	0h181C	PID Mode	PID mode select	0 Process PID	0:Process PID	212	213	O	O	O	X	X
				1 Normal PID								
29	0h181D	PID Limit Hi	PID upper limit frequency	PID lower limit frequency (Hz)-300 (Hz)	60.00	O	213	O	O	O	X	X
30	0h181E	PID Limit Lo	PID lower limit frequency	-300-PID upper limit frequency (Hz)	-60.00	O	213	O	O	O	X	X
31	0h181F	PID Out Inv	PID output inverse	0 No	0:No	212	213	O	O	O	X	X
				1 Yes								
32	0h1820	PID Out Scale	PID output scale	0.1-1000 (%)	100.0	X	213	O	O	O	X	X
34	0h1822	Pre-PID Freq	PID control period movement frequency	0-maximum frequency (Hz)	0.00	X	213	O	O	O	X	X
35	0h1823	Pre-PID Exit	PID control period movement level	0-100 (%)	0.0	X	213	O	O	O	X	X
36	0h1824	Pre-PID Delay	PID control period movement delay time	0-9999 (sec)	600	O	213	O	O	O	X	X
37	0h1825	PID Sleep DT	PID sleep mode delay time	0-999.9 (sec)	60.0	O	213	O	O	O	X	X
38	0h1826	PID Sleep Freq	PID sleep mode frequency	0-maximum frequency (Hz)	0.00	O	213	O	O	O	X	X
39	0h1827	PID WakeUp Lev	PID wake up level	0-100 (%)	35	O	213	O	O	O	X	X
40	0h1828	PID WakeUp Mod	PID wake up mode setting	0 Below Level	0:Below Level	O	213	O	O	O	X	X
				1 Above Level								
				2 Beyond Level								
41	0h1829	PID Rev Run En	PID reverse operation	0 No	0:No	X	213	O	O	O	X	X
				1 Yes								
42				0 %	0:%	O	213	O	O	O	X	X
				1 Bar								
				2 mBar								
				3 Pa								

Function Table

Table of Functions

No.	Communi- cation Address	LCD Display	Name	Setting Range	Initial Value	Shift in Opera- tion	Page	Control Mode						
								V / F	S L	V C	S L T	V C T		
				4 KPa										
				5 Hz										
				6 rpm										
				7 V										
				8 I										
				9 kW										
				10 HP										
				11 °C										
				12 °F										
43	0h182B	PID Unit Gain	PID unit gain	0-300 (%)	100.00	O	213	O	O	O	X	X	X	X
44	0h182C	PID Unit Scale	PID unit scale	0 X 0.01	2:x 1	O	213	O	O	O	X	X	X	X
				1 X 0.1										
				2 X 1										
				3 X 0.1										
				4 X 0.01										
45	0h182D	PID P2-Gain	PID 2 nd proportional gain	0-1000 (%)	100.0	X	213	O	O	O	X	X	X	X

Note 31) APP 16-45 codes are displayed only when APP-01 (App Mode) is set as "Proc PID" or APP-01(App Mode) is set as "MMC" and Requi Bypass (APO-34) is set as "No".

13.9 Parameter Mode – Option Module Function Group (→APO)

Option Module Function Group (PAR → APO)

No.	Communi- cation Address	LCD Display	Name	Setting Range	Initial Value	Shift in Opera- tion	Page	Control Mode					
								V / F	S L	V L	S L T	V C T	
00	-	Jump Code	Jump code	0-99	20	O		O	O	O	O	O	
01 <small>Note37)</small>	0h1A01	Enc Opt Mode	Encoder function item	0	None	0:None	O	150	O	O	O	O	O
				1	Feedback								
				2	Reference								
04	0h1A04	Enc Type Sel	Encoder type selection	0	Line Driver	0:Line Driver	X	150	O	O	O	O	O
				1	Totem or Com								
				2	Open Collector								
05	0h1A05	Enc Pulse Sel	Encoder pulse direction	0	(A+B)	0: (A+B)	X	150	O	O	O	O	O
				1	-(A+B)								
				2	A								
06	0h1A06	Enc Pulse Num	Number of encoder pulses	10-5000	1024	X	150	O	O	O	O	O	
08	0h1A08	Enc Monitor	Feedback monitor	-	-	O	150	O	O	O	O	O	
09	0h1A09	Pulse Monitor	Reference monitor	-	-	O	150	O	O	O	O	O	
10	0h1A0A	Enc Filter	Encoder input filter	0-10000 (ms)	3	O	150	O	O	O	O	O	
11	0h1A0B	Enc Pulse x1	Encoder minimum input pulse	0-100 (kHz)	0.0	O	150	O	X	O	X	O	
12	0h1A0C	Enc Perc y1	Output at encoder minimum pulse (%)	0-100 (%)	0.00	O	150	O	X	O	X	O	
13	0h1A0D	Enc Pulse x2	Encoder maximum input pulse	0-200 (kHz)	100	O	150	O	X	O	X	O	
14	0h1A0E	Enc Perc y2	Encoder maximum pulse output (%)	0-100 (%)	100	O	150	O	X	O	X	O	
20 <small>Note38)</small>	0h1A14	Aux Motor Run	Display of number of auxiliary motor movements	0-4	0	O	270	O	O	O	X	X	
21	0h1A15	Starting Aux	Starting auxiliary motor selection	1-4	1	X	270	O	O	O	X	X	
22	0h1A16	AutoOp Time	Auto change operation time	X:XX (Min)	0:00	O	270	O	O	O	X	X	
23	0h1A17	Start Freq 1	1st auxiliary motor starting frequency	0-60 (Hz)	49.99	O	270	O	O	O	X	X	
24	0h1A18	Start Freq 2	2nd auxiliary motor starting frequency	0-60 (Hz)	49.99	O	270	O	O	O	X	X	
25	0h1A19	Start Freq 3	3rd auxiliary motor starting frequency	0-60 (Hz)	49.99	O	270	O	O	O	X	X	
26	0h1A1A	Start Freq 4	4th auxiliary motor starting frequency	0-60 (Hz)	49.99	O	270	O	O	O	X	X	

Function
Table

Table of Functions

No.	Communication Address	LCD Display	Name	Setting Range	Initial Value	Shift in Operation	Page	Control Mode				
								V / F	S / L	V / C	S / L	V / C
27	0h1A1B	Stop Freq 1	1st auxiliary motor stop frequency	0-60 (Hz)	15.00	O	270	O	O	O	X	X
28	0h1A1C	Stop Freq 2	2nd auxiliary motor stop frequency	0-60 (Hz)	15.00	O	270	O	O	O	X	X
29	0h1A1D	Stop Freq 3	3rd auxiliary motor stop frequency	0-60 (Hz)	15.00	O	270	O	O	O	X	X
30	0h1A1E	Stop Freq 4	4th auxiliary motor stop frequency	0-60 (Hz)	15.00	O	270	O	O	O	X	X
31	0h1A1F	Aux Start DT	Auxiliary motor starting delay time	0-3600.0 (sec)	60.0	O	270	O	O	O	X	X
32	0h1A20	Aux Stop DT	Auxiliary motor stop delay time	0-3600.0 (sec)	60.0	O	270	O	O	O	X	X
33	0h1A21	Num of Aux	Auxiliary motor number selection	0-4	4	X	270	O	O	O	X	X
34	0h1A22	Regul Bypass	Bypass selection	0 No	0:No	X	270	O	O	O	X	X
				1 Yes								
35	0h1A23	Auto Ch Mode	Auto change mode selection	0 None	1:Aux	X	270	O	O	O	X	X
				1 Aux								
				2 Main								
36	0h1A24	Auto Ch Time	Auto change time	0-99:00 (min)	72:00	O	270	O	O	O	X	X
38	0h1A26	Interlock	Interlock selection	0 No	0:No	O	270	O	O	O	X	X
				1 Yes								
39	0h1A27	Interlock DT	Interlock movement delay time	0.1-360.0 (sec)	5.0	O	270	O	O	O	X	X
40	0h1A28	Actual Pr Diff	Auxiliary motor movement pressure difference	0-100 (%)	2	O	270	O	O	O	X	X
41	0h1A29	Aux Acc Time	Main motor acceleration time when number of pumps decreases	0-600.0 (sec)	2.0	O	270	O	O	O	X	X
42	0h1A2A	Aux Dec Time	Main motor deceleration time when number of pumps increases	0-600.0 (sec)	2.0	O	270	O	O	O	X	X
58 Note39)	0h1A3A	PLC LED Status	PLC option LED status	-	-	O	Option	O	O	O	O	O
59	0h1A3B	PLC S/W Ver	PLC option module S/W version	-	1.X	O	Option	O	O	O	O	O
60	0h1A3C	PLC Wr Data 1	PLC write data 1	0-FFFF (Hex)	0000	O	Option	O	O	O	O	O
61	0h1A3D	PLC Wr Data 2	PLC write data 2	0-FFFF (Hex)	0000	O	Option	O	O	O	O	O
62	0h1A3E	PLC Wr Data 3	PLC write data 3	0-FFFF (Hex)	0000	O	Option	O	O	O	O	O
63	0h1A3F	PLC Wr Data 4	PLC write data 4	0-FFFF (Hex)	0000	O	Option	O	O	O	O	O
64	0h1A40	PLC Wr Data 5	PLC write data 5	0-FFFF (Hex)	0000	O	Option	O	O	O	O	O
65	0h1A41	PLC Wr Data 6	PLC write data 6	0-FFFF (Hex)	0000	O	Option	O	O	O	O	O

No.	Communication Address	LCD Display	Name	Setting Range	Initial Value	Shift in Operation	Page	Control Mode				
								V / F	S L	V C	S L T	V C T
66	0h1A42	PLC Wr Data 7	PLC write data 7	0-FFFF (Hex)	0000	O	Option	O	O	O	O	O
67	0h1A43	PLC Wr Data 8	PLC write data 8	0-FFFF (Hex)	0000	O	Option	O	O	O	O	O
76	0h1A4C	PLC Rd Data 1	PLC read data 1	0-FFFF (Hex)	0000	O	Option	O	O	O	O	O
77	0h1A4D	PLC Rd Data 2	PLC read data 2	0-FFFF (Hex)	0000	O	Option	O	O	O	O	O
78	0h1A4E	PLC Rd Data 3	PLC read data 3	0-FFFF (Hex)	0000	O	Option	O	O	O	O	O
79	0h1A4F	PLC Rd Data 4	PLC read data 4	0-FFFF (Hex)	0000	O	Option	O	O	O	O	O
80	0h1A50	PLC Rd Data 5	PLC read data 5	0-FFFF (Hex)	0000	O	Option	O	O	O	O	O
81	0h1A51	PLC Rd Data 6	PLC read data 6	0-FFFF (Hex)	0000	O	Option	O	O	O	O	O
82	0h1A52	PLC Rd Data 7	PLC read data 7	0-FFFF (Hex)	0000	O	Option	O	O	O	O	O
83	0h1A53	PLC Rd Data 8	PLC read data 8	0-FFFF (Hex)	0000	O	Option	O	O	O	O	O

* The grey cells indicate a hidden code which is only visible when setting a code.

Note 37) APO-01-14 codes are displayed only when the encoder module is installed.

Note 38) APO-20-42 codes are displayed only when APP-01 (App Mode) is set as "MMC".

Note 39) APO-58-83 codes are displayed only when the PLC option module is installed.

13.10 Parameter Mode – Protective Function Group (→PRT)

Protective Function Group (PAR → PRT)

No.	Communication Address	LCD Display	Name	Setting Range	Initial Value	Shift in Operation	Page	Control Mode			
								V / F	S L C	V L T	S L T
00	-	Jump Code	Jump code	0-99	40	O		O	O	O	O
04	0h1B04	Load Duty	Load amount setting	0 Normal Duty	1:Heavy Duty	X	310	O	O	O	O
				1 Heavy Duty							
05	0h1B05	Phase Loss Chk	Input/output open-phase protection	Bit 00-11	00	X	317	O	O	O	O
				1 Output open phase							
				2 Input open phase							
06	0h1B06	IPO V Band	Input voltage range during open-phase	1-100 (V)	40	X	317	O	O	O	O
07	0h1B07	Trip Dec Time	Deceleration time at fault trip	0-600 (sec)	3.0	O	319	O	O	O	O
08	0h1B08	RST Restart	Starting selection on trip reset	0 No	0:No	O	247	O	O	O	O
				1 Yes							
09	0h1B09	Retry Number	Number of automatic restarts	0-10	0	O	247	O	O	O	O
10 <small>Note40)</small>	0h1B0A	Retry Delay	Automatic restart delay time	0-60.0 (sec)	1.0	O	247	O	O	O	O
11	0h1B0B	Lost KPD Mode	Keypad command loss operation mode	0 None	0:None	O	319	O	O	O	O
				1 Warning							
				2 Free-Run							
				3 Dec							
12	0h1B0C	Lost Cmd Mode	Speed command loss operation mode	0 None	0:None	O	321	O	O	O	O
				1 Free-Run							
				2 Dec							
				3 Hold Input							
				4 Hold Output							
5 Lost Preset											
13 <small>Note41)</small>	0h1B0D	Lost Cmd Time	Speed command loss judgment time	0.0-120 (sec)	1.0	O	321	O	O	O	O
14	0h1B0E	Lost Preset F	Operation frequency at speed command loss	Start frequency -maximum frequency (Hz)	0.00	O	321	O	O	O	O
15	0h1B0F	AI Lost Level	Analog input loss judgment level	0 Half of x1	0:Half of x1	O	321	O	O	O	O
				1 Below x1							
17	0h1B11	OL Warn Select	Overload alarm selection	0 No 1 Yes	0:No	O	310	O	O	O	O
18	0h1B12	OL Warn Level	Overload alarm level	30-180 (%)	150	O	310	O	O	O	O
19	0h1B13	OL Warn Time	Overload alarm time	0-30.0 (sec)	10.0	O	310	O	O	O	O
20	0h1B14	OL Trip Select	Motion at overload trip	0 None	1:Free-Run	O	310	O	O	O	O
				1 Free-Run							
				2 Dec							

Protective Function Group (PAR → PRT)

No.	Communication Address	LCD Display	Name	Setting Range	Initial Value	Shift in Operation	Page	Control Mode				
21	0h1B15	OL Trip Level	Overload trip level	30–200 (%)	180	O	310	O	O	O	O	O
22	0h1B16	OL Trip Time	Overload trip time	0–60 (sec)	60.0	O	310	O	O	O	O	O
25	0h1B19	UL Warn Sel	Under load alarm selection	0 No 1 Yes	0:No	O	324	O	O	O	O	O
26	0h1B1A	UL Warn Time	Under load alarm time	0–600.0 (sec)	10.0	O	324	O	O	O	O	O
27	0h1B1B	UL Trip Sel	Under load trip selection	0 None 1 Free-Run 2 Dec	0:None	O	324	O	O	O	O	O
28	0h1B1C	UL Trip Time	Under load trip time	0–600 (sec)	30.0	O	324	O	O	O	O	O
29	0h1B1D	UL LF Level	Under load lower limit level	10–30 (%)	30	O	324	O	O	O	O	O
30	0h1B1E	UL BF Level	Under load upper limit level	10–100 (%)	30	O	324	O	O	O	O	O
31	0h1B1F	No Motor Trip	Operation on no motor trip	0 None 1 Free-Run	0: None	O	330	O	O	O	O	O
32 <small>Note(42)</small>	0h1B20	No Motor Level	No motor detection current level	1–100 (%)	5	O	330	O	O	O	O	O
33	0h1B21	No Motor Time	No motor detection delay	0.1–10.0 (sec)	3.0	O	330	O	O	O	O	O
34	0h1B22	Thermal-T Sel	Operation at motor overheat detection	0 None 1 Free-Run 2 Dec	0:None	O	315	O	O	O	O	O
35	0h1B23	Thermal In Src	Thermal sensor input	0 None 1 V1 2 I1 3 V2 4 I2	0:None	X	315	O	O	O	O	O
36	0h1B24	Thermal-T Lev	Thermal sensor fault level	0–100 (%)	50.0	O	315					
37	0h1B25	Thermal-T Area	Thermal sensor fault area	0 Low 1 High	0:Low	O	315	O	O	O	O	O
40	0h1B28	ETH Trip Sel	Electronic thermal fault trip prevention selection	0 None 1 Free-Run 2 Dec	0:None	O	308	O	O	O	O	O
41	0h1B29	Motor Cooling	Motor cooling fan type	0 Self-cool 1 Forced-cool	0:Self-cool	O	308	O	O	O	O	O
42	0h1B2A	ETH 1min	Electronic thermal one minute rating	120–200 (%)	150	O	308	O	O	O	O	O
43	0h1B2B	ETH Cont	Electronic thermal prevention continuous rating	50–200 (%)	120	O	308	O	O	O	O	O
45	0h1B2D	BX Mode	BX mode select	0 (sec) 0.1–600.0 (sec)	Free-run Dec	0.0 (Free-run)	O	328	O	O	O	X

Function Table

Table of Functions

Protective Function Group (PAR → PRT)

No.	Communication Address	LCD Display	Name	Setting Range	Initial Value	Shift in Operation	Page	Control Mode				
								V/F	S/L	V/C	S/L	V/C
50	0h1B32	Stall Prevent	Stall prevention	Bit 00000–11111	00000	X	312	O	O	X	O	X
				0 0001 Accelerating (Mode1)								
				1 0001 Accelerating (Mode2)								
				0 0010 Steady speed (Mode1)								
				1 0010 Steady speed (Mode2)								
				# 0100 Decelerating								
# 1000 Flux Braking												
51	0h1B33	Stall Freq 1	Stall frequency 1	Start frequency -stall frequency 1 (Hz)	60.00	O	312	O	O	X	O	X
52	0h1B34	Stall Level 1	Stall level 1	30–250 (%)	180	X	312	O	O	X	O	X
53	0h1B35	Stall Freq 2	Stall frequency 2	Stall frequency 1 -stall frequency 2 (Hz)	60.00	O	312	O	O	X	O	X
54	0h1B36	Stall Level 2	Stall level 2	30–250 (%)	180	X	312	O	O	X	O	X
55	0h1B37	Stall Freq 3	Stall frequency 3	Stall frequency 2 -stall frequency 4 (Hz)	60.00	O	312	O	O	X	O	X
56	0h1B38	Stall Level 3	Stall level 3	30–250 (%)	180	X	312	O	O	X	O	X
57	0h1B39	Stall Freq 4	Stall frequency 4	Stall frequency 3 -maximum frequency (Hz)	60.00	O	312	O	O	X	O	X
58	0h1B3A	Stall Level 4	Stall level 4	30–250 (%)	180	X	312	O	O	X	O	X
66	0h1B42	DB Warn %ED	DB resistance warning level	0–30 (%)	0	O	322	O	O	O	O	O
70	0h1B46	Over SPD Freq	Overspeed decision frequency	20–130 (%)	120.0	O	325	X	X	O	X	O
72	0h1B48	Over SPD Time	Overspeed judgment time	0.01–10.00 (sec)	0.01	O	325	X	X	O	X	O
73	0h1B49	Speed Dev Trip	Speed error failure	0 No 1 Yes	0:No	O	325	X	X	O	X	X
74	0h1B4A	Speed Dev Band	Speed error width	2-maximum frequency (Hz)	20.00	O	325	X	X	O	X	X
75	0h1B4B	Speed Dev Time	Speed error judgment time	0.1–1000.0 (sec)	1.0	O	325	X	X	O	X	X
77	0h1B4D	Enc Wire Check	Encoder option connection check	0 No 1 Yes	0:No	O	326	X	X	O	X	O
78	0h1B4E	Enc Check Time	Encoder connection check time	0.1–1000.0 (sec)	1.0	O	326	X	X	O	X	O
79	0h1B4F	FAN Trip Mode	Cooling fan fault selection	0 Trip 1 Warning	1:Warning	O	327	O	O	O	O	O
80	0h1B50	Opt Trip Mode	Operation selection on optional module trip	0 None 1 Free-Run 2 Dec	1:Free-Run	O	329	O	O	O	O	O
81	0h1B51	LVT Delay	Low voltage trip decision delay time	0–60.0 (sec)	0.0	X	327	O	O	O	O	O
82	0h1B52	LV2 Enable	Select 'Low Voltage2' during	0 No	0:No	X	330	O	O	O	O	O

No.	Communi-	LCD Display	Name	Setting Range	Initial	Shift in	Page	Control Mode						
			operation	1 Yes										

* The grey cells indicate a hidden code which is only visible when setting a code.

Note 40) PRT-10 codes are displayed only when PRT-09(Retry Number) is set above "0".

Note 41) PRT-13-15 codes are displayed only when PRT-12(Lost Cmd Mode) is not "None".

Note 42) PRT-32-33 codes are displayed only when PRT-31(No Motor Trip) is set as "Free-Run".

13.11 Parameter Mode – 2nd Motor Function Group (→M2)

2nd Motor Function Group (PAR → M2)

No.	Communi- cation Address	LCD Display	Name	Setting Range	Initial Value	Shift in Operation	Page	Control Mode				
								V / F	S L C	V L T	S V C T	
00	-	Jump Code	Jump code	0-99	14	O	-	O	O	X	O	X
04	0h1C04	M2-Acc Time	Acceleration time	0-600 (sec)	Below 75 kW: 20.0 Above 90 kW: 60.0	O	251	O	O	X	O	X
05	0h1C05	M2-Dec Time	Deceleration time	0-600 (sec)	Below 75 kW: 30.0 Above 90 kW: 90.0	O	251	O	O	X	O	X
06	0h1C06	M2-Capacity	Motor capacity	0 0.2 kW 21 185 kW	-	X	251	O	O	X	O	X
07	0h1C07	M2-Base Freq	Base frequency	30-400 (Hz)	60.00	X	251	O	O	X	O	X
08	0h1C08	M2-Ctrl Mode	Control mode	0 V/F 1 V/F PG 2 Slip Compon 3 Sensorless-1 4 Sensorless-2	0:V/F	X	251	O	O	X	O	X
10	0h1C0A	M2-Pole Num	Motor pole	2-48	Dependent on motor capacity	X	251	O	O	X	O	X
11	0h1C0B	M2-Rated Slip	Rated slip speed	0-3000 (rpm)		X	251	O	O	X	O	X
12	0h1C0C	M2-Rated Curr	Motor rated current	1.0-1000.0 (A)		X	251	O	O	X	O	X
13	0h1C0D	M2-No-load Curr	Motor no-load current	0.5-1000.0 (A)		X	251	O	O	X	O	X
14	0h1C0E	M2-Rated Volt	Motor rated voltage	180-480 (V)		X	251	O	O	X	O	X
15	0h1C0F	M2-Efficiency	Motor efficiency	70-100 (%)		X	251					
16	0h1C10	M2-Inertia Rt	Load inertia ratio	0-8		X	251	O	O	X	O	X
17	-	M2-Rs	Stator resistance	0-9.999 (Ω)		X	251					
18	-	M2-Lsigma	Leak inductance	0-99.99 (mH)		X	251					
19	-	M2-Ls	Stator inductance	0-999.9 (mH)		X	251	O	O	X	O	X
20	-	M2-Tr	Rotor time constant	25-5000 (ms)	X	251	O	O	X	O	X	
25	0h1C19	M2-V/F Patt	V/F pattern	0 Linear 1 Square 2 User V/F	0:Linear	X	251	O	O	X	O	X
26	0h1C1A	M2-Fwd Boost	Forward torque boost	0-15 (%)	Below 75 kW: 2.0	X	251	O	O	X	O	X
27	0h1C1B	M2-Rev Boost	Reverse torque boost	0-15 (%)	Above 90 kW: 1.0	X	251	O	O	X	O	X
28	0h1C1C	M2-Stall Lev	Stall prevention level	30-150 (%)	150	X	251	O	O	X	O	X
29	0h1C1D	M2-ETH 1min	Electronic thermal one minute rating	100-200 (%)	150	X	251	O	O	X	O	X
30	0h1C1E	M2-ETH Cont	Electronic thermal continuous rating	50-150 (%)	100	X	251	O	O	X	O	X
40	0h1C28	M2-	Revolution display gain	0.1-6000.0 (%)	100.0	O	251	O	O	O	O	O

Function Table

Table of Functions

No.	Communi-	LCD Display	Name	Setting Range	Initial Value	Shift in	Page	Control Mode						
		LoadSpdGain												
41	0h1C29	M2- LoadSpdScal	Revolution display scale	0 x 1	0:x 1	O	251	O	O	O	O	O	O	
				1 x 0.1										
				2 x 0.01										
				3 x 0.001										
				4 x 0.0001										
42	0h1C2A	M2-LoadSpdUnit	Revolution display unit	0 Rpm 1 Mpm	0:rpm	O	251	O	O	O	O	O		

13.12 Trip Mode (TRP Current (or Last-x))

Trip Mode (TRP Last-x)

No.	LCD Display	Name	Setting Range	Initial Value	Page
00	Trip Name (x)	Trip type display	-	-	289
01	Output Freq	Output frequency at trip	-	-	289
02	Output Current	Output current at trip	-	-	289
03	Inverter State	Acc/Dec status at trip	-	-	289
04	DCLink Voltage	DC voltage	-	-	289
05	Temperature	NTC temperature	-	-	289
06	DI State	Status of input terminals	-	0000 0000	289
07	DO State	Status of output terminals	-	000	289
08	Trip On Time	Trip time since power on	-	0/00/00 00:00	289
09	Trip Run Time	Trip time since operation start	-	0/00/00 00:00	289
10	Trip Delete	Delete trip history	0	No	0:No
			1	Yes	

13.13 Config Mode (CNF)

Config Mode (CNF)

No.	LCD Display	Name	Setting Range	Initial Value	Page
00	Jump Code	Jump code	0-99	1	-
01	Language Sel	Keypad language selection	0. English	0. English	307
			1. Russian		
			2. Español		
			3. Polski		
4. Turkish					
02	LCD Contrast	LCD contrast adjustment	-	-	264

Table of Functions

No.	LCD Display	Name	Setting Range	Initial Value	Page
10	Inv S/W Ver	Inverter S/W version	-	1.XX	264
11	KeypadS/W Ver	Keypad S/W version	-	1.XX	264
12	KPD Title Ver	Keypad title version	-	1.XX	264
20 <small>Note43)</small>	Anytime Para	Status display	0	Frequency	0: Frequency 288
21	Monitor Line-1	Monitor mode display 1	1	Speed	0: Frequency 284
22	Monitor Line-2	Monitor mode display 2	2	Output Current	2:Output Current 284
23	Monitor Line-3	Monitor mode display 3	3	Output Voltage	3:Output Voltage 284
			4	Output Power	
			5	WHour Counter	
			6	DCLink Voltage	
			7	DI State	
			8	DO State	
			9	V1 Monitor (V)	
			10	V1 Monitor (%)	
			11	I1 Monitor (mA)	
			12	I1 Monitor (%)	
			13	V2 Monitor (V)	
			14	V2 Monitor (%)	
			15	I2 Monitor (mA)	
			16	I2 Monitor (%)	
			17	PID Output	
			18	PID ref Value	
			19	PID Fdb Value	
20	Torque				
21	Torque Limit				
22	Trq Bias Ref				
23	Speed Limit				
24	Load Speed				
25	Temperature				
24	Mon Mode Init	Monitor mode initialization	0	No	0:No 284
			1	Yes	
30	Option-1 Type	Option slot 1 type display	0	None	0:None Option
31	Option-2 Type	Option slot 2 type display	1	PLC	0:None Option
32	Option-3 Type	Option slot 3 type display	2	Profi	0:None Option
			3	Ext. I/O	
			4	Encoder	
			0	No	
40	Parameter Init	Parameter initialization	1	All Grp	- 257
			2	DRV Grp	
			3	BAS Grp	
			4	ADV Grp	
			5	CON Grp	
			6	IN Grp	
			7	OUT Grp	
			8	COM Grp	

Function Table

Table of Functions

No.	LCD Display	Name	Setting Range	Initial Value	Page
			9 APP Grp		
			10 AUT Grp		
			11 APO Grp		
			12 PRT Grp		
			13 M2 Grp		
41	Changed Para	Display changed parameter	0 View All 1 View Changed	0:View All	260
42	Multi Key Sel	Multi-function key item	0 None	0:None	260
			1 JOG Key		
			2 Local/Remote		
			3 UserGrp SelKey		
43	Macro Select	Macro function item	0 None	0:None	262
			1 Draw App		
			2 Traverse		
44	Erase All Trip	Delete trip history	0 No	0:No	264
			1 Yes		
45	UserGrp AllDel	Delete user registration code	0 No	0:No	260
			1 Yes		
46	Parameter Read	Read parameters	0 No	0:No	256
			1 Yes		
47	Parameter Write	Write parameters	0 No	0:No	256
			1 Yes		
48	Parameter Save	Save parameters	0 No	0:No	256
			1 Yes		
50	View Lock Set	Hide parameter mode	0-9999	Unlocked	258
51	View Lock Pw	Password for hiding parameter mode	0-9999	Password	258
52	Key Lock Set	Lock parameter edit	0-9999	Unlocked	259
53	Key Lock Pw	Password for locking parameter edit	0-9999	Password	259
60	Add Title Del	Additional title update	0 No	0:No	264
			1 Yes		
61	Easy Start On	Simple parameter setting	0 No	0:No	263
			1 Yes		
62	WHCount Reset	Power consumption initialization	0 No	0:No	264
			1 Yes		
70	On-time	Accumulated inverter motion time	0000DAY 00hr:00mm	-	264
71	Run-time	Accumulated inverter operation time	0000DAY 00hr:00mm	-	264
72	Time Reset	Accumulated inverter operation time initialization	0 No	0:No	264
			1 Yes		
74	Fan Time	Accumulated cooling fan operation time	0000DAY 00hr:00mm	-	264
75	Fan Time Rst	Accumulated cooling fan operation time initialization	0 No	-	264
			1 Yes		

Note 43) Item 7 and 8 are not in the Anytime Para item.

13.14 User/Macro Mode – Draw Operation Function Group → MC1

U&M → MC1

No.	LCD Display	Name	Setting Range	Initial Value	Page
00	Jump Code	Jump code	0-99	1	-
01	Acc Time	Acceleration time	0-600 (sec)	Below 75 kW	20
				Above 90 kW	60
02	Dec Time	Deceleration time	0-600 (sec)	Below 75 kW	30
				Above 90 kW	90
03	Cmd Source	Command source	0-5	1:FX/Rx-1	159
04	Freq Ref Src	Frequency reference source	0-9	2:V1	137
05	Control Mode	Control mode	0-5	0:V/F	174
06	Aux Ref Src	Auxiliary reference source	0-4	2:1	194
07	Aux Calc Type	Auxiliary calculation type	0-7	0	194
08	Aux Ref Gain	Auxiliary reference gain	-200-200 (%)	100.0	194
09	V1 Polarity	V1 input polarity selection	0-1	0:Unipolar	138
10	V1 Filter	V1 input filter time constant	0-10000 (ms)	10	138
11	V1 Volt x1	V1 minimum input voltage	0-10 (V)	0.00	138
12	V1 Perc y1	Output at V1 minimum voltage (%)	0-100 (%)	0.00	138
13	V1 Volt x2	V1 maximum input voltage	0-10 (V)	10.00	138
14	V1 Perc y2	Output at V1 maximum voltage (%)	0-100 (%)	100.00	138
15	V1 -Volt x1'	V1 -minimum input voltage	-10-0 (V)	0.00	138
16	V1 -Perc y1'	Output at V1 -minimum voltage (%)	-100-0 (%)	0.00	138
17	V1 -Volt x2'	V1 -maximum input voltage	-10-0 (V)	-10.00	138
18	V1 -Perc y2'	Output at V1 -maximum voltage (%)	-100-0 (%)	-100.00	138
19	V1 Inverting	Rotation direction change	0-1	0:No	138
20	I1 Monitor(mA)	I1 input amount display	0-20 (mA)	0.00	146
21	I1 Polarity	I1 polarity display	0-1	0	146
22	I1 Filter	I1 input filter time constant	0-10000 (ms)	10	146
23	I1 Curr x1	I1 minimum input current	0-20 (mA)	4.00	146
24	I1 Perc y1	Output at I1 minimum current (%)	0-100 (%)	0.00	146
25	I1 Curr x2	I1 maximum input current	4-20 (mA)	20.00	146
26	I1 Perc y2	Output at I1 maximum current (%)	0-100 (%)	100.00	146
27	I1 Curr x1'	I1 -minimum input current	-20-0 (mA)	0.00	146
28	I1 Perc y1'	Output at I1 - minimum current (%)	-100-0 (%)	0.00	146
29	I1 Curr x2'	I1 - maximum input current	-20-0 (mA)	-20.00	146
30	I1 Perc y2'	Output at I1 maximum current (%)	-100-0 (%)	-100.00	146
31	I1 Inverting	Rotation direction change	0-1	0:No	146
32	P1 Define	P1 terminal function setting	0-48	0:FX	159
33	P2 Define	P2 terminal function setting	0-48	1:RX	159
34	P3 Define	P3 terminal function setting	0-48	5:BX	328

13.15 User/Macro mode – Traverse Operation Function Group (→MC2)

Traverse Operation Function Group (U&M → MC2)

No.	LCD Display	Name	Setting Range	Initial Value	Page	
00	Jump Code	Jump code	0–99	1	-	
01	Acc Time	Acceleration time	0–600 (sec)	Below 75 kW	20	266
				Above 90 kW	60	
02	Dec Time	Deceleration time	0–600 (sec)	Below 75 kW	30	266
				Above 90 kW	90	
03	Cmd Source	Command source	0–5	1:Fx/Rx-1	266	
04	Freq Ref Src	Frequency reference source	0–9	0:Keypad-1	266	
05	Control Mode	Control mode	0–5	0:V/F	266	
06	App Mode	Applied function selection	0–4	1:Traverse	266	
07	Trv Apmitt %	Traverse operating range	0–20 (%)	0.0	266	
08	Trv Scramb %	Traverse scramble magnitude	0–50 (%)	0.0	266	
09	Trv Acc Time	Traverse acceleration time	0.1–600 (sec)	2.0	266	
10	Trv Dec Time	Traverse deceleration time	0.1–600 (sec)	2.0	266	
11	Trv Offset Hi	Traverse offset upper limit	0–20 (%)	0.0	266	
12	Trv Offset Lo	Traverse offset lower limit	0–20 (%)	0.0	266	
13	P1 Define	P1 terminal function setting	0–48	0:FX	266	
14	P2 Define	P2 terminal function setting	0–48	1:RX	266	
15	P3 Define	P3 terminal function setting	0–48	5:BX	266	
16	P4 Define	P4 terminal function setting	0–48	27:Trv	266	
17	P5 Define	P5 terminal function setting	0–48	28:Trv	266	

14 Safety Function STO(Safe Torque Off)

The iS7 Inverter series provides resilient safety features via optional safety expansion module. When an emergency arises, it instantly blocks inverter output to protect the operator and reduce the risk.

14.1 Safety Standard Product

The performance levels for the safety function are as follows.

EN ISO 13849-1: Category 3, PL Class d

EN 61508: SIL 2 (EN 60204-1, Stop Category 0)

ⓘ Caution

When using the safety function, perform a risk assessment for the system and ensure that it meets the safety requirements.

Note

When wiring the inverter or performing maintenance, the inverter must be turned off. The safety function is not used to block the power supply to the motor or insulate the inverter electrically.

14.2 About the Safety Function

The safety function is a safety torque off (STO) function used to prevent a torque and to block the power supply to the motor by interrupting the gate using hard wires.

STO (Safety Torque Off): IEC61800-5-2

The STO function is independently connected to each input signal for 2 channels (SE(SFT11) and SP(SFT2)). The connected circuit cuts off the operation signal for the inverter output and turns off the power modules.

If the safety function is activated during operation, the inverter blocks the output and the motor enters Free Run mode. Also, the "Safety Opt Err" message is displayed on the keypad.

To release the fault trip, short-circuit terminal block to return to the normal operation status and press the [STOP/RESET] key.

14.2.1 Safety Function Wiring Diagram

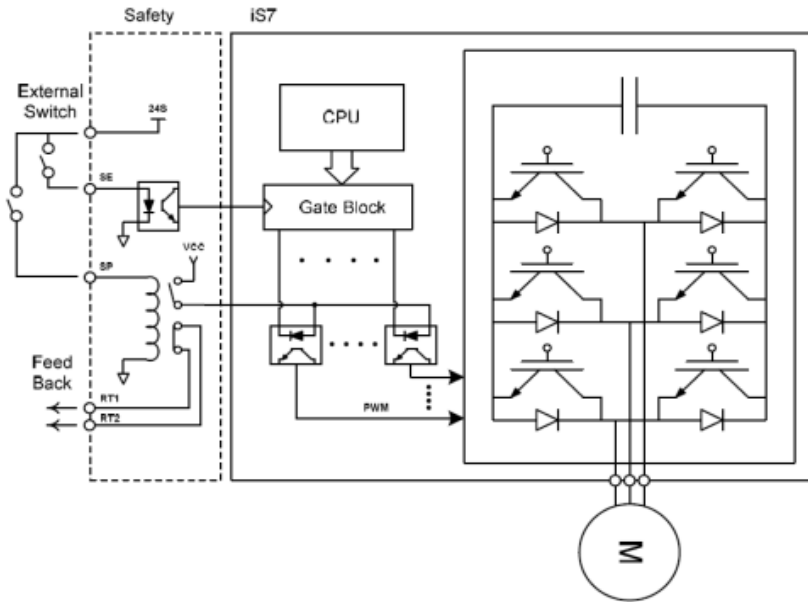

14.2.2 Installing the Safety Board to 0.75–160 kW Product

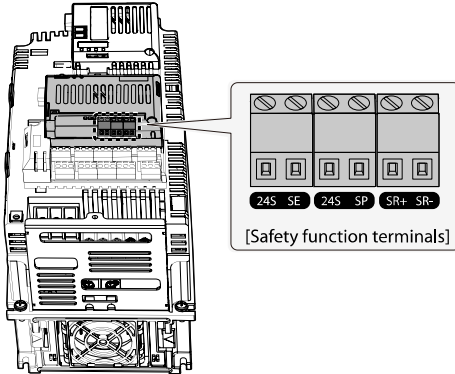

⚠ Caution

Because 0.75–160kW products provide safety purpose product, therefore please use this product with safety option.
Safety options are not available for general products.

14.2.3 Installing the Safety Board to 185–375 kW Product

Please buy safety option and apply to standard products because there is no safety product for 185–375kW.

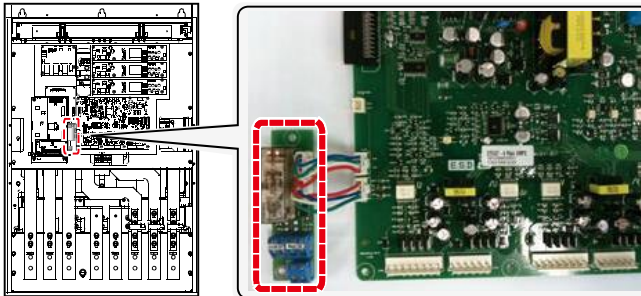

Refer to the following figure and install the safety board to the main SMPS board of the inverter using cable connectors.

14.2.4 Safety Function Terminal Description

24S – SE (SFT1)	24S – SP (SFT2)	SR + SR-
Short: Normal operation	Short: Normal operation	B Contact relay output terminal
Open: Safety Trip (output blockage)	Open: Safety Trip (output blockage)	

14.2.5 Cable Specification for Signal Terminal Block Wiring

Terminal		Wire Thickness		Electrical Standard
Variety	Name	mm ²	AWG	
24S	Safety Input power	0.33–1.25mm ² (16–22 AWG) Shield type twisted-pair wire		24 VDC, Max. 10 mA
SE	Safety Input 1 (SFT1)			Short: Safety function stop (24S-SE or SP) Open: Safety function operation (24S- SP or SP)
SP	Safety Input 2 (SFT2)			
SR+,SR-	Safety function completion output relay			DC 24 V, 5 A below (B contact)

⚠ Caution

The length of the safety wiring at the input terminal must be less than 30 m. Longer wiring can Using over 30M may cause malfunctions because of noise.

15 Marine Certification

Marine classification is that the structure and equipment of the ship has been estimated from the test with the certain standards for certificate issued and given by classification society. SV-IS7 Series is certificated with product testing, process, production equipment and test equipment to install on the shipping.

15.1 DNV (Det Norske Veritas) Marine Certification Details

Certification Institute	DNV (Det Norske Veritas)
Certificate Number	TAE00001S1
Certified Model Types	Frequency Converter for Asynchronous Motors SV series (Range: 0.75 kW–375 kW 200–400 VAC supply)
Compliance	Det Norske Veritas' Rules for Classification of Ships, High Speed & Light Craft Det Norske Veritas' Offshore Standards

15.2 Bureau Veritas (Marine & Offshore Division) Marine Certification Details

Certification Institute	Bureau Veritas (Marine&Off shore Division)
Certificate Number	40183/AO BV
Certified Model Types	SV-IS7 series (Range: 0.75 kW–75 kW, 200V / 0.75 kW–375 kW, 400V)
Compliance	Bureau Veritas Rules for the Classification of Steel Ships

15.3 ABS Marine Certification Details

Certification institute	ABS (American Bureau of Shipping)
Certificate Number	14-BK1291913-PDA
Certified Model Types	SV-IS7 series (Range: 0.75 kW–75 kW, 200V / 0.75 kW–90 kW, 400V)
Compliance	Installation of the product on an ABS class vessel, MODU or facility

15.4 KR Marine Certification Details

Certification institute	KR (Korean Resister)
Certificate Number	PTD25585-AC003
Certified Model Types	SV-iS7 series (Range: 0.75 kW–75 kW, 200V / 0.75 kW–375 kW, 400V)
Compliance	Korean Resister's Rules for Classification of Steel Ships

15.5 Marine Certification Models for SV-iS7 Products

Type		DNV	BV	ABS	KR
3-Phase 200V	SV0008iS7-2□□□□V	O	O	O	O
	SV0015iS7-2□□□□V	O	O	O	O
	SV0022iS7-2□□□□V	O	O	O	O
	SV0037iS7-2□□□□V	O	O	O	O
	SV0055iS7-2□□□□V	O	O	O	O
	SV0075iS7-2□□□□V	O	O	O	O
	SV0110iS7-2□□□□V	O	O	O	O
	SV0150iS7-2□□□□V	O	O	O	O
	SV0185iS7-2□□□□V	O	O	O	O
	SV0220iS7-2□□□□V	O	O	O	O
	SV0300iS7-2□□□□V	O	O	O	O
	SV0370iS7-2□□□□V	O	O	O	O
	SV0450iS7-2□□□□V	O	O	O	O
	SV0550iS7-2□□□□V	O	O	O	O
	SV0750iS7-2□□□□V	O	O	O	O
	3-Phase 400V	SV0008iS7-4□□□□V	O	O	O
SV0015iS7-4□□□□V		O	O	O	O
SV0022iS7-4□□□□V		O	O	O	O
SV0037iS7-4□□□□V		O	O	O	O
SV0055iS7-4□□□□V		O	O	O	O
SV0075iS7-4□□□□V		O	O	O	O
SV0110iS7-4□□□□V		O	O	O	O
SV0150iS7-4□□□□V		O	O	O	O
SV0185iS7-4□□□□V	O	O	O	O	

Type	DNV	BV	ABS	KR
SV0220iS7-4□□□□V	O	O	O	O
SV0300iS7-4□□□□V	O	O	O	O
SV0370iS7-4□□□□V	O	O	O	O
SV0450iS7-4□□□□V	O	O	O	O
SV0550iS7-4□□□□V	O	O	O	O
SV0750iS7-4□□□□V	O	O	O	O
SV0900iS7-4□□□□V	O	O	O	O
SV1100iS7-4□□□□V	O	O	X	O
SV1320iS7-4□□□□V	O	O	X	O
SV1600iS7-4□□□□V	O	O	X	O
SV1850iS7-4□□□□V	O	O	X	O
SV2200iS7-4□□□□V	O	O	X	O
SV2800iS7-4□□□□V	O	O	X	O
SV3150iS7-4□□□□V	O	O	X	O
SV3750iS7-4□□□□V	O	O	X	O

Classified
Product

16 Using a Single Phase Power Source

16.1 Single Phase Rating

The SV-IS7 series inverter is a three-phase variable frequency drive (VFD). When applying single-phase power to a three-phase VFD, there are several limitations that need to be considered.

The standard pulse-width-modulated (PWM) VFDs use a 6-pulse diode rectifier. The 6-pulse rectification results in 360 Hz (or 300 Hz) DC bus ripple when using a three-phase 60 Hz (or 50 Hz) power supply. However, when using a single-phase power source, the DC bus ripple becomes 120 Hz (or 100 Hz). The input current and harmonics increase, and the VFDs DC bus circuit is subject to higher stress in order to deliver equivalent power.

Input current distortion of 90% THD and greater can be expected under single-phase input, compared to approximately 40% with three-phase input as indicated in Figure 2.

Therefore, use of a single-phase requires the three-phase VFD power rating to be reduced (derated) to avoid over stressing the rectifier and the DC link components.

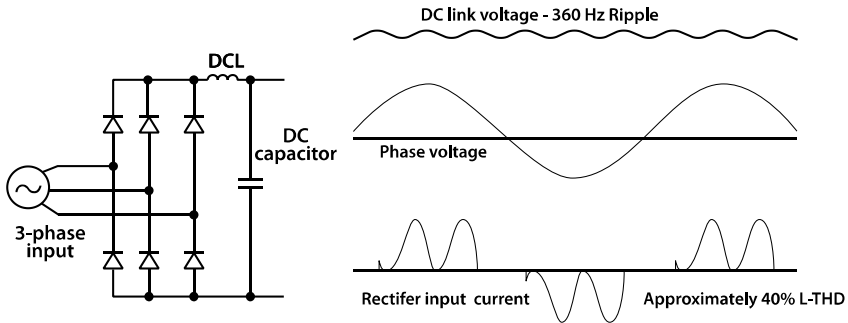

<Figure-1 Typical 60 Hz Three-Phase Configuration>

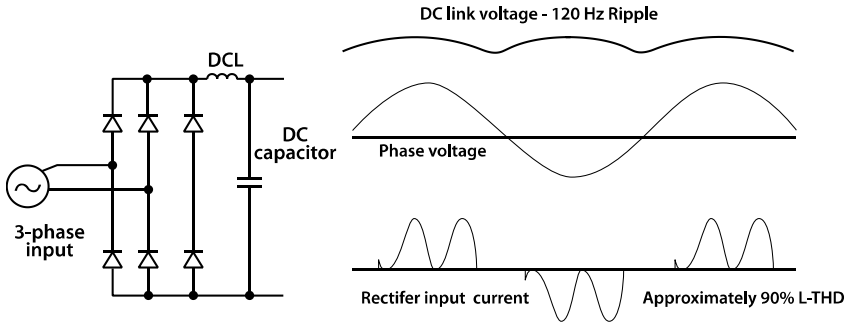

<Figure-2 Typical 60 Hz Single-Phase Configuration>

16.2 Power(HP), Input Current and Output Current

When using a three-phase VFD with single-phase input, derating the drive's output current and horsepower will be necessary due to the increase in DC bus ripple voltage and current. In addition, the input current through the remaining two phases on the diode bridge converter will approximately double, creating another derating consideration for the VFD. Input current harmonic distortion will increase, making the overall input power factor low.

Input current distortion over 100% is likely under single-phase conditions without a reactor. Therefore, the reactor is always required for such applications.

Using a motor that is selected by the three-phase drive ratings with single-phase input may result in poor performance and premature drive failure.

The selected drive of single-phase current ratings must meet or exceed the motor current ratings as indicated in the following table.

16.3 Input Frequency and Voltage Tolerance

The AC supply voltage must be within the required voltage range of 240/480 VAC +10% to -5% to maximize motor power production.

The standard product with three-phase voltage input has an allowable range of +10% to -15%. A stricter input voltage tolerance of +10 to -5% applies when using the drive with a single-phase supply. The average bus voltage with single-phase input is lower than the equivalent of a three-phase input. Therefore, the maximum output voltage (motor voltage) will be lower with a single-phase input.

The minimum input voltage must be no less than 228 VAC for 240 volt models and 456 VAC for 480 V models, to ensure motor voltage production of 207 VAC and 415 VAC, respectively.

If full motor torque must be developed near the base speed (full power) it will be necessary to maintain a rigid incoming line voltage so that adequate motor voltage can be produced.

Operating a motor at reduced speed (reduced power), or using a motor with a base voltage that is lower than the incoming AC supply rating (ex. 208 VAC motor with a 240 VAC supply) will also minimize the effect of voltage deprivation (240 VAC Input for 208 V motor, 480 VAC Input for 400 V motor).

16.4 Wiring and Peripheral Device

It is important that input wiring and branch circuit protection be selected based on the drive's single-phase input current rating indicated in Table 1-2.

The single-phase input current after derating differs from the three-phase input indicated on the VFD nameplate.

Refer to the following figure and connect the single-phase AC input wiring to the inverter's R[L1] and T[L3] terminals.

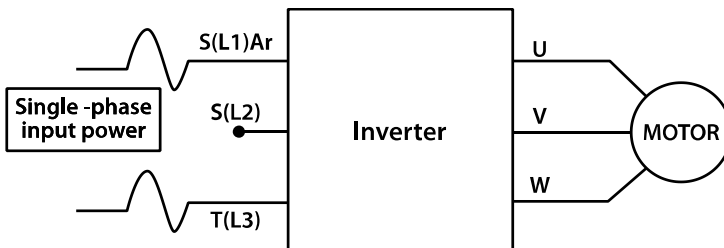

<Figure-3 Terminal Wiring Diagram>

Single-Phase Rating (240 V / 50-60 Hz Input)													
[kW]	[HP]	Single-Phase Current Rating				Wire Selection		FUZE		DC Link Choke		MCCB	Electronic Contactor
		Output Amp		Input Amp		AWG		[A]	[V]	[mH]	[A]	LS ELECTRIC(UL Type)	
		HD [A]	ND [A]	HD [A]	ND [A]	R,S,T	U,V,W						
0.75kW	1	2.6	4.1	4.3	6.8	14	14	10	500V	Built-in	UTE100/15A	MC-9b	
1.5kW	2	4.0	6.0	6.9	10.6	14	14	15			UTE100/15A	MC-12b	
2.2kW	3	6.2	8.2	11.2	14.9	14	14	20			UTE100/30A	MC-18b	
3.7kW	5	8.1	12	14.9	21.3	12	12	32			UTE100/30A	MC-32a	
5.5kW	7.5	12	16	22.1	28.6	10	10	50			UTS150/50A	MC-40a	
7.5kW	10	16	23	28.6	41.2	8	8	63			UTS150/60A	MC-50a	
11kW	15	24	31	44.3	54.7	6	6	80			UTS150/100A	MC-65a	
15kW	20	31	38	55.9	69.7	4	4	100			UTS150/125A	MC-100a	
18.5kW	25	38	45	70.8	82.9	2	2	125			UTS150/150A	MC-130a	
22kW	30	45	64	85.3	116.1	1	1	160			UTS250/175A	MC-150a	
30kW	40	60	75	121.0	152.0	1/0	1/0	200		0.24	200	UTS250/225A	MC-150a
37kW	50	75	93	154.0	190.0	2/0	2/0	250		0.2	240	UTS400/300A	MC-225a
45kW	60	93	114	191.0	231.0	2/0	2/0	350		0.17	280	UTS400/350A	MC-330a
55kW	75	114	149	233.0	302.0	3/0	3/0	400		0.12	360	UTS600/500A	MC-400a
75kW	100	149	178	305.0	362.0	4/0	4/0	450	0.1	500	UTS600/600A	MC-630a	

Table 1. Single-Phase Rating(240 V Type)

Using a Single Phase Power Source

Single-Phase Rating (480 V / 50-60 Hz Input)													
[kW]	[HP]	Single-Phase Current Rating				Wire Selection		FUSE		DC Link Choke	MCCB	Electronic Contactor	
		Output Amp		Input Amp		AWG		[A]	[V]				
		HD [A]	ND [A]	HD [A]	ND [A]	R,S,T	U,V,W			[mH]	[A]	LS ELECTRIC(UL Type)	
0.75kW	1	1.4	2.2	2.2	3.7	14	14	10	500V	Built-in	UTE100/15A	MC-9b	
1.5kW	2	2.1	3.2	3.6	5.7	14	14	10			UTE100/15A	MC-9b	
2.2kW	3	2.8	4.1	5.5	7.7	14	14	15			UTE100/15A	MC-12b	
3.7kW	5	4.1	6.1	7.5	11.1	14	14	20			UTE100/15A	MC-18b	
5.5kW	7.5	6.1	8.0	11.0	14.7	12	12	32			UTE100/30A	MC-22b	
7.5kW	10	8.1	12	14.4	21.9	12	12	35			UTE100/30A	MC-32a	
11kW	15	12	16	22.0	26.4	10	10	50			UTS150/50A	MC-40a	
15kW	20	16	20	26.6	35.5	8	8	63			UTS150/60A	MC-50a	
18.5kW	25	20	23	35.6	41.1	6	6	70			UTS150/80A	MC-65a	
22kW	30	23	31	41.6	55.7	4	4	100			UTS150/100A	MC-65a	
30kW	40	32	39	55.5	67.5	4	4	125			UTS150/125A	MC-100a	
37kW	50	39	47	67.9	81.7	4	2	125			UTS150/150A	MC-130a	
45kW	60	47	57	82.4	101.8	1	1	160			UTS250/175A	MC-150a	
55kW	75	57	78	102.6	143.6	1/0	1/0	200			UTS250/225A	MC-185a	
75kW	100	78	94	143.4	173.4	2/0	2/0	250			UTS400/300A	MC-225a	
90kW	120	95	116	174.7	212.9	4/0	4/0	350			UTS400/400A	MC-330a	
110kW	150	116	138	213.5	254.2	4/0	4/0	400			UTS600/500A	MC-400a	
132kW	180	134	165	255.6	315.3	300	300	450			UTS600/600A	MC-400a	
160kW	225	166	189	316.3	359.3	400	400	450	UTS600/600A	MC-630a			

Table 2. Single-Phase Rating (480 V Type)

16.5 Other Considerations

The following lists other precautions that need to be considered when using a three-phase VFD using single-phase power source.

- Depending on the increased DC ripple, sensorless mode may result in poor performance when operating a three-phase inverter using single-phase power supply.
- If a phase open trip occurs, cancel the input phase open protection bit setting (PRT-05: Phase Loss Chk).
- Do not allow the current to exceed the single-phase rating. Motor capacity, motor overload trip, and E-thermal functions must be set to protect motor.
- A reactor is always required. Use a model type that comes with built-in DC reactor. The iS7 200 V 30–75kW and 400 V 280–375 kW products do not have built-in DC reactors. Install an external AC reactor separately for these model types (Do not install DC reactors externally).

17 Storage and Disposal

17.1 Storage

If you are not using the product for an extended period, store it in the following way:

- Store the product in the same environmental conditions as specified for operation (refer to [3.1 Installation Considerations](#) on page 17).
- When storing the product for a period longer than 3 months, store it between 0°C and 65°C, to prevent depletion of the electrolytic capacitor.
- Do not expose the drive to snow, rain, fog, or dust.
- Package the inverter in a way that prevents contact with moisture. Keep the moisture level below 70% in the package by including a desiccant, such as silica gel.
- If the product is exposed to a humid or dusty environment, separate the product and then keep it in an adequate environment that is suitable for product operation.

Caution

If the inverter has not been operated for a long time, capacitors may lose their charging characteristics and become depleted. To prevent depletion, turn on the product once a year and allow the device to operate for 30-60 min. Run the device under no-load conditions.

17.2 Disposal

When disposing of the product, categorize it as general industrial waste. Recyclable materials are included in the product, so recycle them whenever possible. The packing materials and all metal parts can be recycled



EC DECLARATION OF CONFORMITY

We, the undersigned,

Representative: **LS ELECTRIC Co., Ltd.**
 Address: **LS Tower, 127, LS-ro, Dongan-gu,
 Anyang-si, Gyeonggi-do,
 Korea**

Manufacturer: **LS ELECTRIC Co., Ltd.**
 Address: **56, Samseong 4-gil, Mokcheon-eup,
 Dongnam-gu, Cheonan-si, Chungcheongnam-do,
 Korea**

Certify and declare under our sole responsibility that the following apparatus:

Type of Equipment: **Inverter (Power Conversion Equipment)**
 Model Name: **STARVERT-IS7 series**
 Trade Mark: **LS ELECTRIC Co., Ltd.**

Conforms with the essential requirements of the directives:

2014/35/EU Directive of the European Parliament and of the Council on the harmonisation of the laws of the Member States relating to the making available on the market of electrical equipment designed for use within certain voltage limits

2014/30/EU Directive of the European Parliament and of the Council on the harmonisation of the laws of the Member States relating to electromagnetic compatibility

Based on the following specifications applied:

**EN IEC 61800-3:2018
 EN 61800-5-1:2007+A1:2017+A11:2021
 EN IEC 63000:2018**

and therefore complies with the essential requirements and provisions of the 2014/30/EU, 2014/35/EU and 2011/65/EU Directives.

Place: **Cheonan, Chungnam,
Korea**

박창근 2022. 8. 16

(Signature/Date)

Mr. PARK CHANGKEUN / Manager

EMI / RFI POWER LINE FILTERS

LS ELECTRIC inverters, iS7 series



RFI FILTERS

THE LS RANGE OF POWER LINE FILTERS **FEP (Standard)** SERIES, HAVE BEEN SPECIFICALLY DESIGNED WITH HIGH FREQUENCY **LS ELECTRIC INVERTERS**, THE USE OF LS FILTERS, WITH THE INSTALLATION ADVICE OVERLEAF HELP TO ENSURE TROUBLE FREE USE ALONG SIDE SENSITIVE DEVICES AND COMPLIANCE TO CONDUCTED EMISSION AND IMMUNITY STANDARS TO EN 50081.

CAUTION

IN CASE OF A LEAKAGE CURRENT PROTECTIVE DEVICES IS USED ON POWER SUPPLY, IT MAY BE FAULT AT POWER-ON OR OFF. IN AVOID THIS CASE, THE SENSE CURRENT OF PROTECTIVE DEVICE SHOULD BE LARGER

RECOMMENDED INSTALLATION INSTRUCTIONS

To conform to the EMC directive, it is necessary that these instructions be followed as closely as possible. Follow the usual safety procedures when working with electrical equipment. All electrical connections to the filter, inverter and motor must be made by a qualified electrical technician.

- 1-) Check the filter rating label to ensure that the current, voltage rating and part number are correct.
- 2-) For best results the filter should be fitted as closely as possible to the incoming mains supply of the wiring enclosure, usually directly after the enclosures circuit breaker or supply switch.
- 3-) The back panel of the wiring cabinet of board should be prepared for the mounting dimensions of the filter. Care should be taken to remove any paint etc... from the mounting holes and face area of the panel to ensure the best possible earthing of the filter.
- 4-) Mount the filter securely.
- 5-) Connect the mains supply to the filter terminals marked LINE, connect any earth cables to the earth stud provided. Connect the filter terminals marked LOAD to the mains input of the inverter using short lengths of appropriate gauge cable.
- 6-) Connect the motor and fit the ferrite core (output chokes) as close to the inverter as possible. Armoured or screened cable should be used with the 3 phase conductors only threaded twice through the center of the ferrite core. The earth conductor should be securely earthed at both inverter and motor ends. The screen should be connected to the enclosure body via and earthed cable gland.
- 7-) Connect any control cables as instructed in their inverter instructions manual.

IT IS IMPORTANT THAT ALL LEAD LENGTHS ARE KEPT AS SHORT AS POSSIBLE AND THAT INCOMING MAINS AND OUTGOING MOTOR CABLES ARE KEPT WELL SEPARATED.

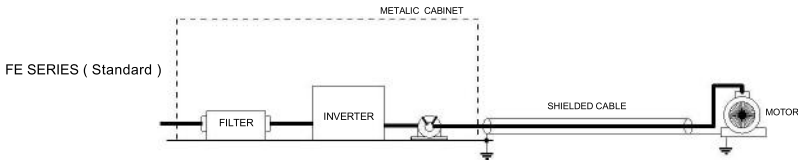

PR0062

iS7 series / Standard Filters											
INVERTER	POWER	CODE	CURRENT	VOLTAGE	LEAKAGE CURRENT	DIMENSIONS L W H	MOUNTING Y X	WEIGHT	MOUNT	FIG.	OUTPUT CHOKES
THREE PHASE											
SV0300IS7-2	30KW	FEP-T180	180A	220-480VAC	0.7mA 80mA	332 x 170 x 120	115 x 155	8.4 Kg	-	B	FS-3
SV0370IS7-2	37KW	FEP-T250	250A	220-480VAC	0.7mA 80mA	392 x 190 x 116	240 x 165	9.1 Kg	-	B	FS-3
SV0450IS7-2	45KW	FEP-T320	320A	220-480VAC	0.7mA 80mA	392 x 260 x 116	240 x 235	9.8 Kg	-	B	FS-4
SV0550IS7-2	55KW	FEP-T320	320A	220-480VAC	0.7mA 80mA	392 x 260 x 116	240 x 235	9.8 Kg	-	B	FS-4
SV0750IS7-2	75KW	FEP-T400	400A	220-480VAC	0.7mA 80mA	392 x 260 x 116	240 x 235	10.3 Kg	-	B	FS-4

SV0300-0750IS7 EN 55011 CLASS A GROUP 2 IEC/EN 61800-3 C3

iS7 series / Standard Filters											
INVERTER	POWER	CODE	CURRENT	VOLTAGE	LEAKAGE CURRENT	DIMENSIONS L W H	MOUNTING Y X	WEIGHT	MOUNT	FIG.	OUTPUT CHOKES
THREE PHASE											
SV0300IS7-4	30KW	FE-T100-2	100A	220-480VAC	1.3mA 150mA	420 x 200 x 130	408 x 166	13.8 Kg	-	A	FS-3
SV0370IS7-4	37KW	FE-T100-2	100A	220-480VAC	1.3mA 150mA	420 x 200 x 130	408 x 166	13.8 Kg	-	B	FS-3
SV0450IS7-4	45KW	FEP-T150	150A	220-480VAC	1.3mA 150mA	332 x 170 x 120	115 x 155	8 Kg	-	B	FS-3
SV0550IS7-4	55KW	FEP-T150	150A	220-480VAC	1.3mA 150mA	332 x 170 x 120	115 x 155	8 Kg	-	B	FS-3
SV0750IS7-4	75KW	FEP-T180	180A	220-480VAC	1.3mA 150mA	332 x 170 x 120	115 x 155	8.4 Kg	-	B	FS-3
SV0900IS7-4	90KW	FEP-T250	250A	220-480VAC	1.3mA 150mA	392 x 190 x 116	240 x 165	9.1 Kg	-	B	FS-4
SV1100IS7-4	110KW	FEP-T400	400A	220-480VAC	1.3mA 150mA	392 x 260 x 116	240 x 235	10.3 Kg	-	B	FS-4
SV1320IS7-4	132KW	FEP-T400	400A	220-480VAC	1.3mA 150mA	392 x 260 x 116	240 x 235	10.3 Kg	-	B	FS-4
SV1600IS7-4	160KW	FEP-T600	600A	220-480VAC	1.3mA 150mA	392 x 260 x 116	240 x 235	11 Kg	-	B	FS-4
SV1850IS7-4	185KW	FEP-T600	600A	220-480VAC	1.3mA 150mA	392 x 260 x 116	240 x 235	11 Kg	-	B	FS-4
SV2200IS7-4	220KW	FEP-T1000	1000A	220-480VAC	1.3mA 150mA	460 x 280 x 166	290 x 255	18 Kg	-	B	FS-4
SV2800IS7-4	280KW	FEP-T1000	1000A	220-480VAC	1.3mA 150mA	460 x 280 x 166	290 x 255	18 Kg	-	B	FS-4
SV3150IS7-4	315KW	FEP-T1000	1000A	220-480VAC	1.3mA 150mA	460 x 280 x 166	290 x 255	18 Kg	-	B	FS-4
SV3750IS7-4	375KW	FEP-T1600	1600A	220-480VAC	1.3mA 150mA	592 x 300 x 166	340 x 275	27 Kg	-	B	FS-4

SV0300-2200 iS7-4 EN 55011 CLASS A GROUP 2 IEC/EN 61800-3 C3

SV2800-3750 iS7-4 EN 55011 CLASS A IEC/EN 61800-3 C4

FE SERIES (Standard)

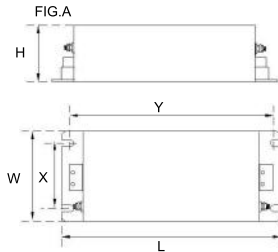
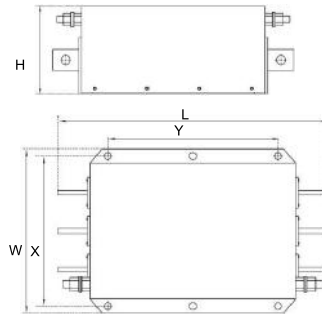

FIG.B



Vector Motor Control Ibérica S.L.
 C/ Mar del Cantib, 10
 Pol. Ind. La Torre del Rector
 08130 Santa Perpètua de Mogoda
 (BARCELONA) ESPAÑA
 Tel. (+34) 935 748 206
 Fax (+34) 935 748 248
 info@vmc.es www.vmc.es



FS SERIES (output chokes)						
CODE	L	W	H	X	Ø	
FS - 3	48	150	110	125 x 30	5	
FS - 4	58	200	170	180 x 46	5	

Product Warranty

Warranty Information

Fill in this warranty information form and keep this page for future reference or when warranty service may be required.

Product Name	LS ELECTRIC Inverter	Date of Installation	
Model Name	SV-IS7	Warranty Period	
Customer Info	Name (or company)		
	Address		
	Contact Info.		
Retailer Info	Name		
	Address		
	Contact info.		

Warranty Period

The product warranty covers product malfunctions, under normal operating conditions, for 12 months from the date of installation. If the date of installation is unknown, the product warranty is valid for 18 months from the date of manufacturing. Please note that the product warranty terms may vary depending on purchase or installation contracts.

Warranty Service Information

During the product warranty period, warranty service (free of charge) is provided for product malfunctions caused under normal operating conditions. For warranty service, contact an official LS ELECTRIC agent or service center.

Non-Warranty Service

A service fee will be incurred for malfunctions in the following cases:

- intentional abuse or negligence
- power supply problems or from other appliances being connected to the product

- acts of nature (fire, flood, earthquake, gas accidents etc.)
- modifications or repair by unauthorized persons
- missing authentic LS ELECTRIC rating plates
- expired warranty period

Visit Our Website

Visit us at <http://www.ls-electric.com> for detailed service information.

UL Mark



The UL mark applies to products in the United States and Canada. This mark indicates that UL has tested and evaluated the products and determined that the products satisfy the UL standards for product safety. If a product received UL certification, this means that all components inside the product had been certified for UL standards as well.

CE mark



The CE mark indicates that the products carrying this mark comply with European safety and environmental regulations. European standards include the Machinery Directive for machine manufacturers, the Low Voltage Directive for electronics manufacturers and the EMC guidelines for safe noise control.

Low Voltage Directive

We have confirmed that our products comply with the Low Voltage Directive (EN 61800-5-1).

EMC Directive

The Directive defines the requirements for immunity and emissions of electrical equipment used within the European Union. The EMC product standard (EN 61800-3) covers requirements stated for drives.

EAC mark



The EurAsian Conformity mark (EAC) indicates that the product conforms to all technical regulations of the Eurasian Customs Union assessment procedures. This means that it meets all requirements and technical regulations applicable to the product, and that it can be serviced in all service centers of the producer in the territory of all Customs Union member countries.

Index

[ESC] key	110	auto torque boost	180
[Mode] key	110	auto tuning	224
[PROG / Ent] key	110	auto tuning	224
[UP] key	110	All (rotating)	226
2nd motor operation	258	All (static)	227, 229
2 nd operation mode	192	default parameter setting	225
2nd command source	193	auxiliary frequency	196
Shared command (Main Source)	193	auxiliary reference	196
Shared command (Main Source)	193	auxiliary reference gain	197
3-wire operation	208	final command frequency calculation	198
4-pole standard motor	8, 9, 11	frequency configuration	196
Acc/Dec pattern	171	main reference	196
linear pattern	171	basic configuration diagram	86
S-curve pattern	171	bipolar	74, 77, 143
Acc/Dec reference	167	bit setting	194
Delta Freq	166	bit (Off)	194
Max Freq	166	bit (On)	194
Acc/Dec reference frequency	166	brake control	279
Ramp T Mode	166	BR Control	280
Acc/Dec stop	174	brake engage sequence	280, 281
Acc/Dec time	165	brake release sequence	280, 281
Acc/Dec time switch frequency	169	broadcast	363
configuration via multi-function terminal ..	168	built-in surge filter	79
maximum frequency	165	cable	
operation frequency	167	shielded twisted pair	83, 84
add User group		cable tie	301, 311, 334
UserGrp SelKey	268	carrier frequency	255
analog frequency hold	153	charge indicator	57
analog hold	153	charge lamp	57
analog input		command	157
V1 voltage input	138	Cmd Source	157
analog input selection switch (SW2)	149	configuration	157
anti-hunting regulator	293	command source	
asymmetric ground power	55	fwd/rev command	158
asymmetric ground structure		keypad	157
disabling the EMC filter	56	RS-485	160
auto restart settings	253	commercial power source transition	260
auto sequence operation	274	Config (CNF) mode	272
		inverter S/W version	272

keypad S/W version	272	asymmetric power source.....	55
keypad title update	272	disabling	56
LCD contrast.....	272	energy saving operation	248
reset cumulative power consumption	272	automatic energy saving operation	249
connecting cables to the power terminal block.....	61	manual energy saving operation.....	248
0.75–22 kW (200 V/400 V)	61	ESC key	
185–220 kW (400 V).....	64	[ESC] key setup	160
280–375 kW (200 V/400 V).....	65	local/remote switching.....	161
30–75 kW (200 V/400 V).....	62	multi-function key.....	160
90–160 kW (400 V).....	63	remote / local operation switching.....	161
connecting the cables.....	49	expanded I/O control.....	195
considerations for installation.....	17	exterior and dimensions (UL Enclosed Type 1, IP21 Type).....	22
air pressure	17	SV0008-0037iS7 (200 V/400 V).....	22
altitude/vibration.....	17	SV0055-0075iS7 (200 V/400 V).....	23
ambient humidity	17	SV0110-0150iS7 (200 V/400 V).....	24
ambient temperature.....	17	SV0185-0220iS7 (200 V/400 V).....	25
environmental factors.....	17	SV0300-0450iS7 (400 V).....	28
storing temperature	17	SV0300-iS7 (200 V, IP00 Type).....	26
contactors.....	86	SV0370-0450iS7 (200 V, IP00 Type).....	27
cooling fan		SV0550-0750iS7 (200 V, IP00 Type).....	29
fan control	261	SV0550-0750iS7 (400 V).....	30
cursor keys		SV0900-1100iS7 (400 V, IP00 Type).....	31
[UP] key.....	110	SV1320-1600iS7 (400 V, IP00 Type).....	32
DB resistor dimensions.....	105	SV1850-2200iS7 (400 V, IP00 Type).....	33
DB unit dimensions.....	96	SV2800iS7 (400 V, IP00 Type).....	34
DB unit specifications	92	SV3150-3750iS7 (400 V, IP00 Type).....	35
DC braking after stop.....	185	exterior and dimensions (UL Enclosed Type 12, IP54 Type).....	36
DC braking frequency	185	exterior and dimensions (UL Enclosed Type12, IP54 Type)	
DC reactor specifications	89	SV0008-0037iS7 (200 V/400 V).....	36
delta wiring.....	53	SV0055-0075iS7 (200 V/400 V).....	37
derating.....	257	SV0110-0150iS7 (200 V/400 V).....	38
digital source	162	SV0185-0220iS7 (200 V/400 V).....	39
droop control.....	244	FE (Frame Error).....	366
dwel operation.....	210	fieldbus.....	137, 157
Acc/Dec dwell frequency.....	210	communication option.....	192
acceleration dwell.....	210	filter time constant.....	139
deceleration dwell	210	filter time constant number.....	194
easy start	271	fire mode.....	294
easy start mode.....	83	form A terminal (Normally Open).....	194
EEP Rom Empty.....	263		
EMC filter.....	55		

form B terminal (Normally Closed).....	194
forward or reverse run prevention.....	162
frame dimensions and weight.....	40
UL Enclosed Type 1, IP 21 Type	40
UL Enclosed Type 12, IP54 Type.....	42
free-run stop.....	186
frequency hold by analog input.....	153
frequency jump.....	191
frequency limit.....	188
frequency upper and lower limit value	188
maximum/start frequency.....	188
frequency reference.....	138, 183
frequency reference for 0–10V input.....	139
frequency reference for -10–10V Input.....	143
frequency setting.....	137
I1 current input.....	146
I2 current input.....	149
keypad.....	138
pulse input.....	150
RS-485.....	152
terminal V2/I2.....	148
V1 terminal.....	138
frequency upper and lower limit value	
Frequency lower limit value.....	189
Frequency upper limit value.....	189
ground	
class 3 ground.....	58
ground connection.....	58
I2 terminal.....	149
IA (illegal data address).....	366
ID (illegal data value).....	366
IF (illegal function).....	366
initializing accumulated electric energy count...272	
input and output specifications.....	7
200 V Class (0.75–22 kW).....	7
200 V Class (30–75 kW).....	8
400 V Class (0.75–22 kW).....	9
400 V Class (185–375 kW).....	11
400 V Class (30–160 kW).....	10
input phase open	
input open-phase protection.....	334
input power frequency.....	262
input power voltage.....	263
input terminal.....	194
bit setting.....	194
form A (NO) or B (NC) terminal configuration	194
NO/NC configuration.....	194
input terminal contact	
form A contact.....	335
form B contact.....	335
installation.....	17
basic configuration diagram.....	86
location.....	18
installation conditions.....	17
jog operation.....	201
Jog operation	
1-FWD jog.....	201
2-forward/reverse jog.....	202
Jog frequency.....	201
keypad input.....	203
jump frequency.....	191
keypad	
[ESC] key.....	110
[Mode] key.....	110
[PROG / Ent] key.....	110
LCD brightness/contrast.....	272
navigating between groups.....	114
S/W version.....	272
keypad title update.....	272
kinetic energy buffering.....	245
lift-type load.....	171, 179
linear pattern.....	171
linear V/F pattern operation.....	175
base frequency.....	175
start frequency.....	175
local operation.....	161
[ESC] key.....	161
local/remote mode switching.....	160
remote operation.....	161
low leakage PWM.....	256
LS INV 485 Detailed Read Protocol.....	363
LS INV 485 Detailed Write Protocol.....	364

LS INV 485 error code.....	366	normal PWM.....	256
FE (Frame Error)	366	number of motor poles.....	212
IA (illegal data address).....	366	operation noise	255
ID (illegal data value).....	366	carrier frequency.....	255
IF (illegal function)	366	frequency jump	191
WM (write mode error).....	366	operation time monitor.....	322
LS INV 485 protocol.....	361	overload rate.....	257
LSINV 485.....	354	P/I gain.....	253
macro selection	270	parameter	
draw.....	270	display changed parameter.....	268
traverse.....	270	hide parameter mode	266
magnetic contactor	57	parameter initialization	264
manual torque boost.....	179	parameter lock	267
master	353	password.....	266, 267
maximum allowed prospective short-circuit		parameter initialization	264
current.....	iv, 12, 390	parmeter	
MMC function.....	282	read/write/save	263
Modbus-RTU	354	part names.....	4
momentary power interruption.....	252, 253	parts illustrated.....	4
monitor function.....	299	password.....	266, 267
monitoring		PID	
monitor registration protocol details	365	flow control.....	215
motor features		pressure control.....	215
capacity.....	212	speed control	215
efficiency	213	temperature control	215
no-load current	213	PID control.....	215
output voltage setting.....	182	PID basic operation	215
thermal protection(ETH)		PID openloop	224
E-Thermal.....	324	PID operation sleep mode	223
motor protection.....	324	PID operation switching	224
motor thermal protection(ETH).....	324	PID pre operation	222
multi-function input terminal		post-installation checklist.....	82
multi-function input terminal Off filter.....	194	Power-on Run.....	163
multi-function input terminal On filter.....	194	preparing the installation.....	1
multi-function input terminal control	194	product identification.....	1
multi-function output on/off control	282	product specification details.....	13
multi-step frequency.....	154	control	13
setting	154	operation.....	13
Speed-L/Speed-M/Speed-H	155	protection function.....	15
noise.....	55, 141	structure and operating environment control	15

protocol	
LS INV 485 protocol.....	361
PWM.....	255
frequency modulation	255
quantizing.....	141
noise.....	141
R/S/T terminal.....	57
rating	
rated motor current.....	212
rated motor voltage.....	224
rated slip frequency	214
rated slip speed.....	212
rating plate.....	1
reactor.....	86
regenerated energy.....	187
remote operation.....	161
[ESC] key.....	161
local operation.....	161
local/remote mode switching.....	160
resistor brakes.....	86
resonance frequency	
carrier frequency	255
restarting after a trip	
reset and restart	164
retry number	164
ripple.....	141
RS-232.....	353
communication.....	353
RS-485	
communication.....	353
converter.....	353
integrated communication.....	152
signal terminal.....	152
run prevention	
Fwd	163
Rev	163
S/W version.....	272
inverter	272
keypad	272
safe operation mode.....	209
safety information.....	ii
S-curve pattern.....	171
actual Acc/Dec time	173
sensorless-1 vector control	230
sensorless-2 vector control	232
slave.....	353
slip.....	212
slip compensation operation.....	212
speed search configuration.....	251
speed search operation	250
Flying Start-1	250
Flying Start-2.....	251
options	251
P/I gain.....	253
speed unit selection (Hz or Rpm).....	154
speed/torque control switching	244
square reduction	
square reduction load	176
V/F pattern operation	176
stall	
bit On/Off	328
stall prevention	328
start at power-on	
Power-on Run	163
start mode.....	183
acceleration start	183
start after DC braking	183
stop mode.....	184
deceleration stop	184
free run stop.....	186
power braking	187
stop after DC braking.....	185
surge killer.....	57
technical specifications	7
terminal	
form A terminal	194
form B terminal	194
terminal wiring diagram.....	59
test run.....	83
time scale setting.....	166
0.01sec	166
0.1sec.....	166

1sec.....	166	delete parameters	269
timer settings	273	parameter registration.....	269
torque.....	57	user V/F pattern operation.....	177
torque boost.....	179	V/F control.....	175
auto torque boost	180	linear V/F pattern operation	175
manual torque boost.....	179	square reductionV/F pattern operation	176
overexcitation	180, 182	user V/F pattern operation.....	177
torque control.....	242	V/F operation using speed sensor.....	229
traverse operation	278	V2 terminal.....	148
trip		variable torque load.....	176
erasing trip history	272	vector control mode operation	237
U&M mode.....	269	voltage drop.....	57
U/V/W terminal	57	wiring	
Unipolar.....	74, 77	copper cable.....	57
up-down operation.....	204	wiring length	57
User & Macro mode.....	114	WM (write mode error).....	366
User group	268		

Memo

Memo

Memo

Memo

Memo

Memo



LS 021-88406044
09106611367
WWW.LSKALA.COM

www.ls-electric.com

LS ELECTRIC Co., Ltd.

■ Headquarter

LS-ro 127(Hogye-dong) Dongan-gu, Anyang-si, Gyeonggi-Do, 14119, Korea

■ Seoul Office

LS Yongsan Tower, 92, Hangang-daero, Yongsan-gu, Seoul, 04386, Korea

Tel: 82-2-2034-4033, 4888, 4703 Fax: 82-2-2034-4588

E-mail: automation@ls-electric.com

■ Overseas Subsidiaries

• LS ELECTRIC Japan Co., Ltd. (Tokyo, Japan)

Tel: 81-3-6268-8241 E-Mail: japan@ls-electric.com

• LS ELECTRIC (Dalian) Co., Ltd. (Dalian, China)

Tel: 86-411-8730-6495 E-Mail: china.dalian@ls-electric.com.cn

• LS ELECTRIC (Wuxi) Co., Ltd. (Wuxi, China)

Tel: 86-510-6851-6666 E-Mail: china.wuxi@ls-electric.com.cn

• LS ELECTRIC Middle East FZE (Dubai, U.A.E.)

Tel: 971-4-886-5360 E-Mail: middleeast@ls-electric.com

• LS ELECTRIC Europe B.V. (Hoofddorp, Netherlands)

Tel: 31-20-654-1424 E-Mail: europartner@ls-electric.com

• LS ELECTRIC America Inc. (Chicago, USA)

Tel: 1-800-891-2941 E-Mail: sales.us@ls-electric.com

• LS ELECTRIC Türkiye Co., Ltd.

Tel: 90-212-806-1225 E-Mail: turkiye@ls-electric.com

■ Overseas Branches

• LS ELECTRIC Tokyo Office (Japan)

Tel: 81-3-6268-8241 E-Mail: tokyo@ls-electric.com

• LS ELECTRIC Beijing Office (China)

Tel: 86-10-5095-1631 E-Mail: china.auto@ls-electric.com.cn

• LS ELECTRIC Shanghai Office (China)

Tel: 86-21-5237-9977 E-Mail: china.auto@ls-electric.com.cn

• LS ELECTRIC Guangzhou Office (China)

Tel: 86-20-3818-2883 E-Mail: china.auto@ls-electric.com.cn

• LS ELECTRIC Chengdu Office (China)

Tel: 86-28-8670-3201 E-Mail: china.auto@ls-electric.com.cn

• LS ELECTRIC Qingdao Office (China)

Tel: 86-532-8501-2065 E-Mail: china.auto@ls-electric.com.cn

• LS ELECTRIC Nanjing Office (China)

Tel: 86-25-8467-0005 E-Mail: china.auto@ls-electric.com.cn

• LS ELECTRIC Bangkok Office (Thailand)

Tel: 66-90-950-9683 E-Mail: thailand@ls-electric.com

• LS ELECTRIC Jakarta Office (Indonesia)

Tel: 62-21-2933-7614 E-Mail: indonesia@ls-electric.com

• LS ELECTRIC Moscow Office (Russia)

Tel: 7-499-682-6130 E-Mail: info@ls-electric-ru.com

• LS ELECTRIC America Western Office (Irvine, USA)

Tel: 1-949-333-3140 E-Mail: america@ls-electric.com

• LS ELECTRIC Italy office (Italy)

Tel: 39-030-8081-833 E-Mail: italia@ls-electric.com

1031000882

Disclaimer of Liability

LS ELECTRIC has reviewed the information in this publication to ensure consistency with the hardware and software described. However, LS ELECTRIC cannot guarantee full consistency, nor be responsible for any damages or compensation, since variance cannot be precluded entirely. Please check again the version of this publication before you use the product.

© LS ELECTRIC Co., Ltd 2020 All Right Reserved.

SV-IS7 / 2023.03

