

# GD20 Series

UL Certified VFD



**LS** 021-88406044  
09106611367  
[WWW.LSKALA.COM](http://WWW.LSKALA.COM)



## Goodrive20-EU



Goodrive20-EU is a general purpose vector control VFD with certified STO(Safe torque Off) function. It's oriented for OEM equipment markets, mainly covering the applications of water treatment, printing and packaging, paper machinery, shearing, plastic, etc.

### Features

- V/F(SVPWM) and Sensorless Vector Control (SVC).
- External keypad for parameter copy.
- Common DC bus solution (460V;  $\geq 4\text{kW}$ ).
- Starting torque up to 0.5Hz/150%.
- Standard built-in braking unit.
- Standard C3 filter ( $\geq 4\text{kW}$ ), optional C3 filter ( $\leq 2.2\text{kW}$ ) and C2 filter.

## Goodrive20-UL



Goodrive20-UL series mini type general vector VFD, positioned as using the high performance product for small power market. It uses the leading international vector control algorithm, with excellent product features, compatible with wall and rail installation, and product volume is smaller.

### Features

- Mini structure for smaller installation space and parallel/side-by-side installation.
- Advanced PID functions.
- Various installation modes.
- Embedded braking transistors.
- Removable cooling fan for easy maintenance.
- Continuous running in instant power loss.





## Type Selection (GD20-UL)

## GD20 - 2R2G - 4 - UL

① ② ③ ④

Key	No.	Detailed description	Detailed content
Abbreviation	①	Product abbreviation	GD20-EU is short for Goodrive20-EU
Rated power	②	Power range	2R2: 2.2kW G: constant torque load
Voltage degree	③	Voltage degree	S12: AC 1PH 110V~120V S2: AC 1PH 200V~240V 2: AC 3PH 200V~240V 4: AC 3PH 380V~480V
Certification mark	④	Used in America	Certification by UL and CUL *S12 model are certified UL by default without "UL" mark

## Power Ratings (GD20-UL)

Model	Output power (kW)	Output horsepower (kW)	Rated input current (A)	Rated output current (A)	Gross weight (lbs)	Dimensions W*H*D (mm)
AC 1PH 110V~120V						
GD20-0R4G-S12	0.4	0.5	8.1	2.5	3.3	80*185*140.5
GD20-0R7G-S12	0.75	1	15.1	4.2		
GD20-1R1G-S12	1.1	1.5	20	5.8		
AC 1PH 200V~240V						
GD20-0R4G-S2-UL	0.4	0.5	6.5	2.5	2.4	80*160*123.5
GD20-0R7G-S2-UL	0.75	1	9.3	4.2		
GD20-1R5G-S2-UL	1.5	2	15.7	7.5	3.3	80*185*140.5
GD20-2R2G-S2-UL	2.2	3	20	10		
AC 3PH 200V~240V						
GD20-0R4G-2-UL	0.4	0.5	3.7	2.5	3.3	80*185*140.5
GD20-0R7G-2-UL	0.75	1	5.0	4.2		
AC 3PH 380V~480V						
GD20-0R7G-4-UL	0.75	1	3.4	2.5	2.9	80*185*140.5
GD20-1R5G-4-UL	1.5	2	5.0	4.2		
GD20-2R2G-4-UL	2.2	3	5.8	5.5		

## Control Circuit Wiring Diagram

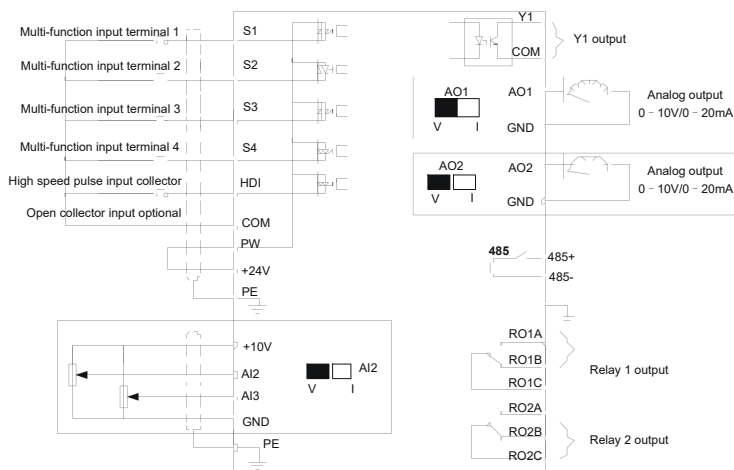









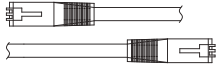

Terminal	Quantity	Description
Digital input	4 (S1-S4)	1kHz, NPN, PNP
High speed pulse input	1 (HDI)	50kHz, NPN, PNP
Analog input	2 (AI2-AI3)	0~10V, 0~20mA, -10V~+10V
ON-OFF output	1 (Y1)	Maximum output frequency: 1kHz
Analog output	2 (AO)	0~10V, 0~20mA
Relay output	2 (RO1-RO2)	3A/250VAC, NO+NC

## Technical specification

Functions		Specifications
Power Input	GD20-UL Input voltage (V) & power	AC 1PH 110V~120V, rated voltage: 110V 0.4~1.1kW(0.5~1.5HP) AC 1PH 200V~240V, rated voltage: 220V 0.4~2.2kW(0.5~3HP) AC 3PH 200V~240V, rated voltage: 220V 0.4~0.75kW(0.5~1HP) AC 3PH 380V~480V, rated voltage: 460V 0.75~2.2kW(1~3HP)
	GD20-EU Input voltage (V) & power	AC 1PH 200V~240V, rated voltage: 230V 0.4~2.2kW(0.5~3HP) AC 3PH 200V~240V, rated voltage: 230V 0.4~2.2kW(0.5~3HP) AC 3PH 380V~480V, rated voltage: 400V 0.75~1.1kW(1~1.5HP)
	Input frequency (Hz)	50Hz or 60Hz; allowed range: 47 – 63Hz
Power Output	Output voltage (V)	0 – input voltage
	Output frequency (Hz)	0 – 400Hz
Technical Control Feature	Control mode	SVPWM, SVC
	Motor	Asynchronous motor
	Adjustable-speed ratio	Asynchronous motor 1:100 (SVC)
	Speed control accuracy	±0.2% (SVC)
	Speed fluctuation	±0.3% (SVC)
	Torque response	<20ms (SVC)
	Torque control accuracy	10%
	Starting torque	0.5Hz/150% (SVC)
Running Control Feature	Frequency setting method	Digital setting, analog setting, pulse frequency setting, multi-step speed running setting, simple PLC setting, PID setting, MODBUS communication setting Shift between the set combination and set channel.
	Auto-adjustment of the voltage	Keep a stable voltage automatically when the grid voltage transients
	Fault protection	Provide comprehensive fault protection functions: overcurrent, overvoltage, undervoltage, overheating, phase loss and overload, etc.
	Start after speed tracking	Smoothing starting for running motor
Peripheral Interface	Analog input	1 (AI2) 0~10V/0~20mA and 1 (AI3) -10~10V
	Analog output	2 (AO1, AO2) 0~10V/0~20mA * AO2 output only available on GD20-EU >2.2kW
	Digital input	4 common inputs, the max. frequency: 1kHz; 1 high speed input, the max. frequency: 50kHz
	GD20-EU Digital output	1 Y1 terminal output
	GD20-UL Digital output	1 Y1 terminal output; 2 programmable relay outputs
	Relay output	2 programmable relay outputs (Only one relay output for VFD ≤ 2.2kW) RO1A NO, RO1B NC, RO1C common terminal RO2A NO, RO2B NC, RO2C common terminal Contactor capacity: 3A/AC250V
Others	Mountable method	Wall and rail mountable
	Braking unit	Standard built-in braking unit
	EMI filter	Optional external filter: meet the degree requirement of IEC61800-3 C2, IEC61800-3 C3
	Temperature of running environment	-10 to 50°C, derate 1% for every increased 1°C when the temperature is higher than 40°C
	Altitude	Below 1000m. If the elevation is above 1000m, derate 1% for every additional 100m.
	Certification	CE, UL, CUL
	Cooling	Fan cooling
	GD20-EU STO level	SIL2/SIL3
Protective degree	IP20 (Standard); NEMA1 kits (optional)	

## Optional parts

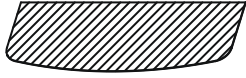
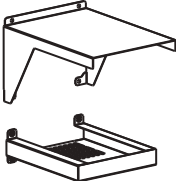
Function	Part	Description	Picture
External Control	LED Keypad	External LED keypad for remote operation of the drive, maximum distance 30m	
	LED Copy Keypad	External copy LED keypad with function of parameter copying for quick commissioning of multiple drives	
	Extension Cable	Various size cables available while use external keypad control	
	Keypad Bracket	Used to install keypad flush on the front of cabinet door	
Reactor	Input Reactor	Suppress inrush voltage, reduce inrush & peak current, improve power factor, reduce harmonics	
	Output Reactor	Reduce transient voltage dv/dt and prolong motor life. It can reduce motor noise, leakage current, output interference and eddy current loss. Solve the problem of long-term output oscillation.	
	DC Reactor	To weaken the high-order harmonic component of the input current and reduce the surge current. Improve power factor, solve the harmonic problem.	
Filter	Input Filter	Control the electromagnetic interference generated from the inverter	
	Output Filter	Control the interference from the output side of the inverter	
Braking	Braking Resistors	Used to shorten deceleration time, and avoid over-voltage issue while in deceleration stop.	
Ingress protection	Dam-Board IP30 Kit	Dam-board kit for installation on inverter side vents. Used for severe environments and improved ingress protection. When installed this kit, the inverter needs to be derated by 10%.	
	NEMA1 Kit	IP21/NEMA 1 Enclosure Kit	

**Marketing service network**

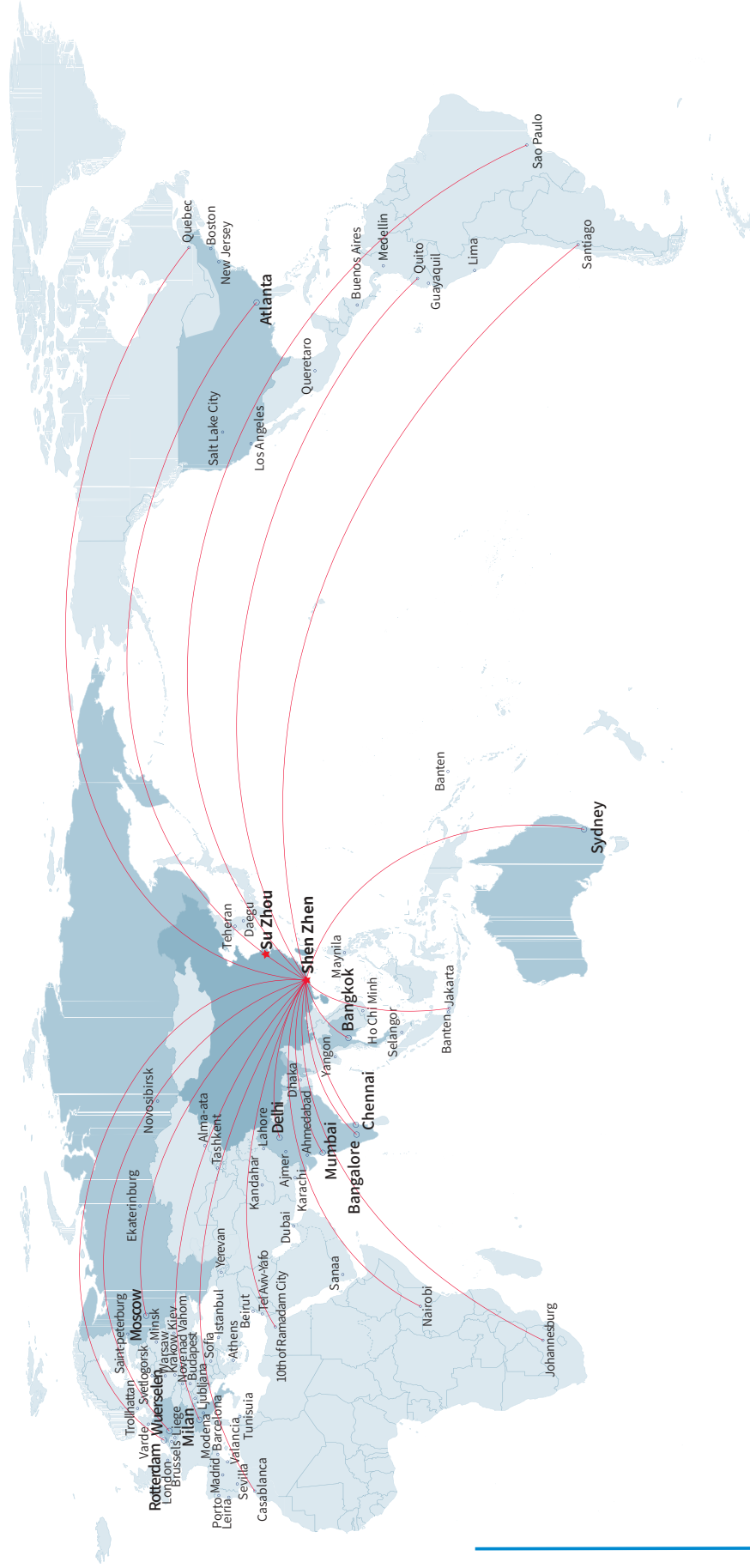

- ★ **INVT Headquarters**
- INVT Sales & Service in 11 countries**
- Sales and Service Partners in 65 countries**

*Your trusted industry automation solution provider*

 021-88406044  
09106611367  
WWW.LSKALA.COM



Service line:86-755-23535967 E-mail:overseas@invt.com.cn Website:www.invt.com

SHENZHEN INVT ELECTRIC CO.,LTD.

INVT Guangming Technology Building, Songbai Road, Matian, Guangming District, Shenzhen, China

- Industrial Automation:**
- Variable-Frequency Drive
  - Servo & Motion Control
  - Motor & Electric Spindle
  - PLC
  - HMI
  - Intelligent Elevator Control System
  - Traction Drive
- Electric Power:**
- SVG
  - Solar Pump Controller
  - UPS
  - Online Energy Management System
  - New Energy Vehicle Electric Control System

INVT Copyright.  
Information may be subject to change without notice during product improving.

66003-00059 20200814(V1.0)