



# Operation Manual

## Goodrive10 Series Mini VFD



 021-88406044  
09106611367  
[WWW.LSKALA.COM](http://WWW.LSKALA.COM)

SHENZHEN INVT ELECTRIC CO., LTD.

# Contents

<b>Contents</b> .....	<b>i</b>
<b>Chapter 1 Safety precautions</b> .....	<b>1</b>
1.1 Safety definition.....	1
1.2 Warning signs.....	1
1.3 Safety guidelines .....	2
<b>Chapter 2 Product overview</b> .....	<b>4</b>
2.1 Quick start .....	4
2.2 Product specifications.....	5
2.3 Nameplate .....	7
2.4 Type designation key.....	7
2.5 Rated specifications .....	7
2.6 Structure diagram .....	8
<b>Chapter 3 Installation</b> .....	<b>10</b>
3.1 Mechanical installation .....	10
3.2 Electrical installation .....	12
3.3 Wiring protection .....	15
<b>Chapter 4 Keypad</b> .....	<b>17</b>
4.1 Keypad description .....	17
4.2 Keypad display .....	19
4.3 Keypad operation .....	20
<b>Chapter 5 Function parameters</b> .....	<b>22</b>
<b>Chapter 6 Fault tracking</b> .....	<b>68</b>
6.1 Fault prevention.....	68
6.2 Fault rectification .....	72
<b>Chapter 7 Communication protocol</b> .....	<b>75</b>
7.1 Modbus protocol introduction.....	75
7.2 Application mode for the VFD.....	75
7.3 RTU command code and communication data description .....	80
<b>Appendix A Technical data</b> .....	<b>91</b>
A.1 Derating in application.....	91
A.2 CE.....	92
A.3 EMC regulations .....	92
<b>Appendix B Dimension drawings</b> .....	<b>94</b>
B.1 Keypad structure.....	94
B.2 VFD chart.....	95

<b>Appendix C Peripheral options and parts .....</b>	<b>96</b>
C.1 Peripheral wiring .....	96
C.2 Power supply .....	97
C.3 Cables .....	97
C.4 Breaker and electromagnetic contactor .....	98
C.5 Reactors .....	99
C.6 Filter .....	100
C.7 Braking system .....	103
<b>Appendix D Further information .....</b>	<b>105</b>
D.1 Product and service inquiries .....	105
D.2 Feedback on INVT VFD manuals.....	105
D.3 Online document library .....	105

## Chapter 1 Safety precautions

Read this manual carefully and follow all safety precautions before moving, installing, operating and servicing the variable-frequency drive (VFD). If ignored, physical injury or death may occur, or damage may occur to the devices.









If any physical injury or death or damage to the devices occurs for ignoring to the safety precautions in the manual, our company will not be responsible for any damages and we are not legally bound in any manner.

### 1.1 Safety definition





- Danger:** Serious physical injury or even death may occur if related requirements are not followed.
- Warning:** Physical injury or damage to the devices may occur if related requirements are not followed.
- Note:** Physical hurt may occur if related requirements are not followed.
- Qualified electricians:** People working on the device should take part in professional electrical and safety training, receive the certification and be familiar with all steps and requirements of installing, commissioning, operating and maintaining the device to avoid any emergency.

### 1.2 Warning signs

Warnings caution you about conditions which can result in serious injury or death and/or damage to the equipment, and advice on how to avoid the danger. Following warning symbols are used in this manual:

Sign	Name	Instruction	Abbreviation
 Danger	Danger	Serious physical injury or even death may occur if related requirements are not followed	
 Warning	Warning	Physical injury or damage to the devices may occur if related requirements are not followed	
 Do not touch	Electrostatic discharge	Damage to the PCBA board may occur if related requirements are not followed	
 Hot sides	Hot sides	Sides of the device may become hot. Do not touch.	
Note	Note	Physical hurt may occur if related requirements are not followed	Note

### 1.3 Safety guidelines

	<ul style="list-style-type: none"> <li>◇ Only qualified electricians are allowed to operate on the VFD.</li> <li>◇ Do not carry out any wiring and inspection or changing components when the power supply is applied. Ensure all input power supply is disconnected before wiring and checking and always wait for at least the time designated on the VFD or until the DC bus voltage is less than 36V. Below is the table of the waiting time:</li> </ul> <table border="1" data-bbox="205 278 946 413"> <thead> <tr> <th colspan="2">VFD model</th> <th>Minimum waiting time</th> </tr> </thead> <tbody> <tr> <td>Single-phase 220V</td> <td>0.2kW-2.2kW</td> <td>5 minutes</td> </tr> <tr> <td>Three-phase 220V</td> <td>0.2kW-2.2kW</td> <td>5 minutes</td> </tr> <tr> <td>Three-phase 380V</td> <td>0.75kW-2.2kW</td> <td>5 minutes</td> </tr> </tbody> </table>	VFD model		Minimum waiting time	Single-phase 220V	0.2kW-2.2kW	5 minutes	Three-phase 220V	0.2kW-2.2kW	5 minutes	Three-phase 380V	0.75kW-2.2kW	5 minutes
VFD model		Minimum waiting time											
Single-phase 220V	0.2kW-2.2kW	5 minutes											
Three-phase 220V	0.2kW-2.2kW	5 minutes											
Three-phase 380V	0.75kW-2.2kW	5 minutes											
	<ul style="list-style-type: none"> <li>◇ Do not refit the VFD unauthorizedly; otherwise fire, electric shock or other injury may occur.</li> </ul>												
	<ul style="list-style-type: none"> <li>◇ The base of the radiator may become hot during running. Do not touch to avoid hurt.</li> </ul>												
	<ul style="list-style-type: none"> <li>◇ The electrical parts and components inside the VFD are electrostatic. Take measurements to avoid electrostatic discharge during relevant operation.</li> </ul>												

#### 1.3.1 Delivery and installation

	<ul style="list-style-type: none"> <li>◇ Install the VFD on fire-retardant material and keep the VFD away from combustible materials.</li> <li>◇ Connect the braking optional parts according to the wiring diagram.</li> <li>◇ Do not operate on the VFD if there is any damage or components loss to the VFD.</li> <li>◇ Do not touch the VFD with wet items or body, otherwise electric shock may occur.</li> </ul>
--	--

#### Note:

- ◇ Select appropriate moving and installing tools to ensure a safe and normal running of the VFD and avoid physical injury or death. For physical safety, the erector should take some mechanical protective measurements, such as wearing exposure shoes and working uniforms.
- ◇ Ensure to avoid physical shock or vibration during delivery and installation.
- ◇ Do not carry the VFD by its cover. The cover may fall off.
- ◇ Install away from children and other public places.
- ◇ The VFD cannot meet the requirements of low voltage protection in IEC61800-5-1 if the altitude of installation site is above 2000m.
- ◇ The pick-up current of the VFD may be above 3.5mA during operation. Ground with proper techniques and ensure the grounding resistor is less than 10Ω. The conductivity of PE grounding conductor is the same as that of the phase conductor (with the same cross sectional area).
- ◇ R, S and T are the input terminals of the power supply, while U, V and W are the motor terminals. Please connect the input power cables and motor cables with proper techniques; otherwise the damage to the VFD may occur.

### 1.3.2 Commissioning and running

	<ul style="list-style-type: none"> <li>✧ Disconnect all power supplies applied to the VFD before the terminal wiring and wait for at least the designated time after disconnecting the power supply.</li> <li>✧ High voltage is present inside the VFD during running. Do not carry out any operation except for the keypad setting.</li> <li>✧ The VFD may start up by itself when P01.21=1. Do not get close to the VFD and motor.</li> <li>✧ The VFD can not be used as "Emergency-stop device".</li> <li>✧ The VFD can not be used to break the motor suddenly. A mechanical braking device should be provided.</li> </ul>
--	--

**Note:**

- ✧ Do not switch on/off the input power supply of the VFD frequently.
- ✧ For VFDs that have been stored for a long time, check and fix the capacitance and try to run it again before utilization (see Maintenance and Hardware Fault Diagnose).
- ✧ Cover the front board before running, otherwise electric shock may occur.



### 1.3.3 Maintenance and replacement of components

	<ul style="list-style-type: none"> <li>✧ Only qualified electricians are allowed to perform the maintenance, inspection, and components replacement of the VFD.</li> <li>✧ Disconnect all power supplies to the VFD before the terminal wiring. Wait for at least the time designated on the VFD after disconnection.</li> <li>✧ Take measures to avoid screws, cables and other conductive matters to fall into the VFD during maintenance and component replacement.</li> </ul>
--	---

**Note:**

- ✧ Select proper torque to tighten screws.
- ✧ Keep the VFD, parts and components away from combustible materials during maintenance and component replacement.
- ✧ Do not carry out any isolation and pressure test on the VFD and do not measure the control circuit of the VFD by megameter.

### 1.3.4 Device disposal

	<ul style="list-style-type: none"> <li>✧ There are heavy metals in the VFD. Deal with it as industrial effluent.</li> </ul>
	<ul style="list-style-type: none"> <li>✧ When the life cycle ends, the product should enter the recycling system. Dispose of it separately at an appropriate collection point instead of placing it in the normal waste stream</li> </ul>

## Chapter 2 Product overview

### 2.1 Quick start

#### 2.1.1 Unpacking inspection

Check as followings after receiving products:

1. Check that there are no damage and humidification to the package. If not, please contact with local agents or INVT offices.
2. Check the information on the type designation label on the outside of the package to verify that the drive is of the correct type. If not, please contact with local dealers or INVT offices.
3. Check that there are no signs of water in the package and no signs of damage or breach to the VFD. If not, please contact with local dealers or INVT offices.
4. Check the information on the type designation label on the outside of the package to verify that the nameplate is of the correct type. If not, please contact with local dealers or INVT offices.
5. Check to ensure the accessories (including user's manual and control keypad) inside the device is complete. If not, please contact with local dealers or INVT offices.

#### 2.1.2 Application confirmation

Check the machine before beginning to use the VFD:

1. Check the load type to verify that there is no overload of the VFD during work and check that whether the drive needs to modify the power degree.
2. Check that the actual current of the motor is less than the rated current of the VFD.
3. Check that the control accuracy of the load is the same of the VFD.
4. Check that the incoming supply voltage is correspondent to the rated voltage of the VFD.

#### 2.1.3 Environment

Check as followings before the actual installation and usage:

1. Check that the ambient temperature of the VFD is below 40°C. If exceeds, derate 1% for every additional 1°C. Additionally, the VFD can not be used if the ambient temperature is above 50° C. Note: for the cabinet VFD, the ambient temperature means the air temperature inside the cabinet.
2. Check that the ambient temperature of the VFD in actual usage is above -10°C. If not, add heating facilities. Note: for the cabinet VFD, the ambient temperature means the air temperature inside the cabinet.
3. Check that the altitude of the actual usage site is below 1000m. If exceeds, derate 1% for every additional 100m.
4. Check that the humidity of the actual usage site is below 90% and condensation is not allowed. If not, add additional protection VFDs.
5. Check that the actual usage site is away from direct sunlight and foreign objects can not enter the VFD. If not, add additional protective measures.
6. Check that there is no conductive dust or flammable gas in the actual usage site. If not, add additional protection to VFDs.

### 2.1.4 Installation confirmation

Check as followings after the installation:

1. Check that the load range of the input and output cables meet the need of actual load.
2. Check that the accessories of the VFD are correctly and properly installed. The installation cables should meet the needs of every component (including reactors, input filters, output reactors, output filters, DC reactors and braking resistors).
3. Check that the VFD is installed on non-flammable materials and the calorific accessories (reactors and brake resistors) are away from flammable materials.
4. Check that all control cables and power cables are run separately and the routation complies with EMC requirement.
5. Check that all grounding systems are properly grounded according to the requirements of the VFD.
6. Check that the free space during installation is sufficient according to the instructions in user's manual.
7. Check that the installation conforms to the instructions in user's manual. The drive must be installed in an upright position.
8. Check that the external connection terminals are tightly fastened and the torque is appropriate.
9. Check that there are no screws, cables and other conductive items left in the VFD. If not, get them out.

### 2.1.5 Basic commissioning

Complete the basic commissioning as followings before actual utilization:

1. Autotune. If possible, de-coupled from the motor load to start dynamic autotune. Or if not, static autotune is available.
2. Adjust the ACC/DEC time according to the actual running of the load.
3. Commission the device via jogging and check that the rotation direction is as required. If not, change the rotation direction by changing the wiring of motor.
4. Set all control parameters and then operate.

### 2.2 Product specifications

Function		Specification
Power input	Input voltage (V)	Single-phase 220(-15%) - 240(+10%) Three-phase 220(-15%) - 240(+10%) Three-phase 380(-15%) - 440(+10%)
	Input current (A)	Refer to 2.5
	Input frequency (Hz)	50Hz or 60Hz      Allowed range: 47-63Hz
Power output	Output voltage (V)	=the input voltage (error<5%)
	Output current (A)	Refer to 2.5
	Output power (kW)	Refer to 2.5
	Output frequency (Hz)	50Hz/60Hz, fluctuation:±5%
Technical control	Control mode	SVPWM
	Maximum output frequency	400Hz



Function		Specification
	Adjustable-speed ratio	1:100
	Overload capability	150% of rated current: 1 minute 180% of rated current: 10 seconds 200% of rated current: 1 second
Peripheral interference	Key functions	Stop mode and anti-temperature of the bus
	Temperature measurement accuracy	Overtemperature point $\pm 3^{\circ}\text{C}$
	Terminal switch input resolution	$\leq 2\text{ms}$
	Terminal analog input resolution	$\leq 20\text{mV}$
	Analog input	1 input 0–10V/0–20mA
	Analog output	1 input 0–10V/0–20mA
Running control	Digital input	5 common input
	Digital output	1 Y output (commonly used with digital output) and 1 programmable relay output
	Communication	485 communication
	Frequency setting	Digital setting, analog setting, multi-step speed setting, PID setting, MODBUS communication setting and so on Switch between different settings
	Automatic voltage adjustment	Keep output voltage stable when the grid voltage changes
	Fault protection	More than 10 fault protections
Others	Mountable method	Wall mountable
	Temperature of the running environment	-10–50°C If temperature is above 40°C, derate 1% for every additional 1°C.
	Cooling	Single/three-phase 220V 0.2-0.75kW natural cooling Single/three-phase 220V 1.5-2.2kW, three-phase 380V 0.75-2.2kW
	Pollution degree	2
	Braking unit	Embedded
	DC reactor	Not optional
	Braking resistor	Optional and external
	EMC filter	Optional C3 or C2 filter

## 2.3 Nameplate

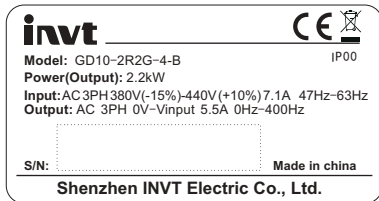

Figure 2-1 Nameplate

**Note:** Figure 2-1 shows an example of a Goodrive10 series VFD nameplate. The CE, TUV, or IP rating is labelled according to product certification.

## 2.4 Type designation key

The type designation contains information on the VFD. The user can find the type designation on the type designation label attached to the VFD or the simple nameplate.

**GD10 - 2R2G - 4 - B**

①                      ②                      ③                      ④

Figure 2-2 Product model

Identifier	Definition	Detailed description
①	Product abbreviation	Goodrive10 is shorted for GD10.
②	Power range + Load type	2R2-2.2kW G—Constant torque load
③	Voltage degree	4: 380(-15%) - 440(+10%) 2: 220(-15%) - 240(+10%) S2: 220(-15%) - 240(+10%)
④	Lot No.	B: standard braking unit

## 2.5 Rated specifications

	Model	Output power(kW)	Input current(A)	Output current (A)
Single-phase 220V	GD10-0R2G-S2-B	0.2	4.9	1.6
	GD10-0R4G-S2-B	0.4	6.5	2.5
	GD10-0R7G-S2-B	0.75	9.3	4.2
	GD10-1R5G-S2-B	1.5	15.7	7.5

	Model	Output power(kW)	Input current(A)	Output current (A)
	GD10-2R2G-S2-B	2.2	24	10
Three-phase 220V	GD10-0R2G-2-B	0.2	1.9	1.6
	GD10-0R4G-2-B	0.4	2.7	2.5
	GD10-0R7G-2-B	0.75	4.9	4.2
	GD10-1R5G-2-B	1.5	9.0	7.5
	GD10-2R2G-2-B	2.2	15	10
Three-phase 380V	GD10-0R7G-4-B	0.75	3.2	2.5
	GD10-1R5G-4-B	1.5	4.3	4.2
	GD10-2R2G-4-B	2.2	7.1	5.5

## 2.6 Structure diagram

Figure 2-3 shows the structure of the VFD (taking the VFD of 2.2kW as an example).

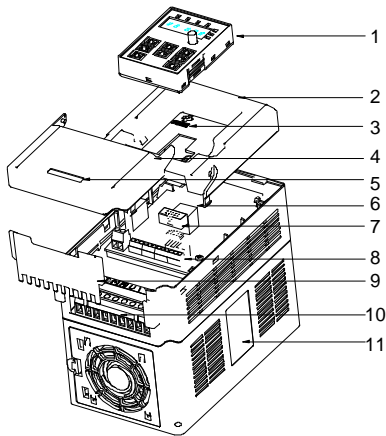

Figure 2-3 Product structure diagram

No.	Name	Illustration
1	Keypad	See chapter 4 "Keypad operation procedure" for detailed information.
2	Cover	To protect the internal parts and components.
3	POWER indicator	POWER indicator
4	Side cover	To protect the internal components.
5	Simple nameplate	See section 2.4 "Type designation key" for detailed

No.	Name	Illustration
		information.
6	Keypad port	To connect the keypad.
7		6 is for external installation.
8	Control circuit terminals	See section 3.2 "Electrical installation" for detailed information.
9	Bobbin winder	To protect the internal parts and components, detachable for wiring
10	Main circuit terminals	See section 3.2 "Electrical installation" for detailed information.
11	Nameplate	See chapter 2 "Product overview" for detailed information.

## Chapter 3 Installation

The chapter describes the mechanical installation and electrical installation.



- ◇ Only qualified electricians are allowed to carry out what described in this chapter. Please operate as the instructions in **Safety Precautions**. Ignoring these may cause physical injury or death or damage to the devices.
- ◇ Ensure the power supply of the VFD is disconnected during the operation. Wait for at least the time designated until the POWER indicator is off after the disconnection if the power supply is applied.
- ◇ The installation and design of the VFD should be complied with the requirement of the local laws and regulations in the installation site. If the installation infringes the requirement, our company will exempt from any responsibility. Additionally, if users do not comply with the suggestion, some damage beyond the assured maintenance range may occur.

### 3.1 Mechanical installation

#### 3.1.1 Installation environment

The installation environment is the safeguard for a full performance and long-term stable functions of the VFD. Check the installation environment as followings:

Environment	Conditions
Installation site	Indoor
Environment temperature	<p>-10° C - +40° C, and the temperature changing rate is less than 0.5°C/minute.</p> <p>If the ambient temperature of the VFD is above 40°C, derate 1% for every additional 1°C.</p> <p>It is not recommended to use the VFD if the ambient temperature is above 60° C (empty load).</p> <p>In order to improve the reliability of the device, do not use the VFD if the ambient temperature changes frequently.</p> <p>Please provide cooling fan or air conditioner to control the internal ambient temperature below the required one if the VFD is used in a close space such as in the control cabinet.</p> <p>When the temperature is too low, if the VFD needs to restart to run after a long stop, it is necessary to provide an external heating device to increase the internal temperature, otherwise damage to the devices may occur.</p>
Humidity	<p>RH≤90%</p> <p>No condensation is allowed.</p> <p>The maximum relative humidity should be equal to or less than 60% in corrosive air.</p>
Storage	-40 °C~+70°C, and the temperature changing rate is less than 1° C/minute.

Environment	Conditions
temperature	
Running environment condition	The installation site of the VFD should: keep away from the electromagnetic radiation source; keep away from contaminative air, such as corrosive gas, oil mist and flammable gas; ensure foreign objects, such as metal power, dust, oil, water can not enter into the VFD(do not install the VFD on the flammable materials such as wood); keep away from direct sunlight, oil mist, steam and vibration environment.
Altitude	When the altitude exceeds 1000m but is lower than 3000m, derate 1% for every additional 100m; When the altitude exceeds 2000m, configure an isolation transformer on the input end of the VFD. When the altitude exceeds 3000m but is lower than 5000m, contact our company for technical consultation. Do not use the VFD at an altitude higher than 5000m.
Vibration	$\leq 5.8\text{m/s}^2(0.6\text{g})$
Installation direction	The VFD should be installed on an upright position to ensure sufficient cooling effect.

**Note:**

- Goodrive10 series VFDs should be installed in a clean and ventilated environment according to enclosure classification.
- Cooling air must be clean, free from corrosive materials and electrically conductive dust.

**3.1.2 Installation direction**

The VFD may be installed on the wall or in a cabinet.

The VFD must be installed in an upright position. Check the installation site according to the requirements below. Refer to Appendix B "Dimension Drawings" in the appendix for frame details.

**3.1.3 Installation manner**

The VFD can be installed in wall mounting (for all frame sizes):

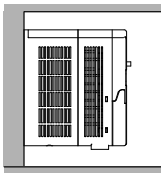

Figure 3-1 Wall mounting

Wall-mounting steps

- (1) Mark the hole location. The location of the holes is shown in the dimension drawings in the appendix.
- (2) Fix the screws or bolts to the marked locations.
- (3) Position the drive onto the wall.
- (4) Tighten the screws in the wall securely.

### A.1.1 Installation space

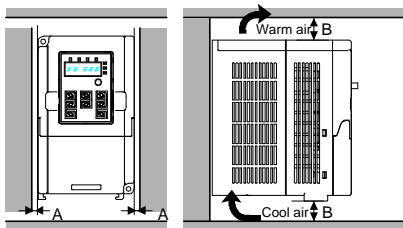

Figure 3-2 Installation space

**Note:** The minimum space of A and B is 100mm.

## 3.2 Electrical installation

### 3.2.1 Connection diagram of main circuit

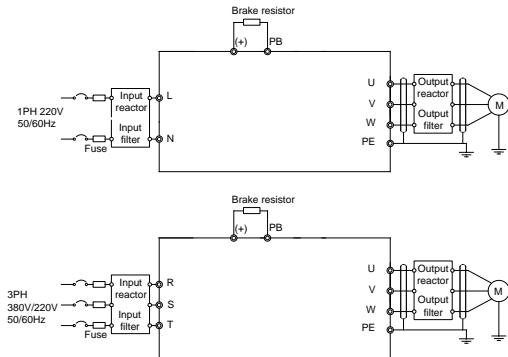

Figure 3-3 Connection diagram of main circuit

**Note:**

- The fuse, DC reactor, braking resistor, input reactor, input filter, output reactor, output filter are optional parts. Refer to Appendix C "Peripheral options and parts" for detailed information.
- Before connecting the braking resistor cable, remove the yellow labels of PB, (+), and (-) from the

terminal blocks. Otherwise, poor connection may occur.

### 3.2.2 Terminals figure of main circuit



R/L	S/N	T	(+)	PB	U	V	W	
-----	-----	---	-----	----	---	---	---	---

Figure 3-4 Terminals of main circuit

Terminal sign	Terminal name	Function
R/L	Power input of the main circuit	3-phase/single-phase AC input terminals which are generally connected with the grid.
S/N		
T		
U	The VFD output	3-phase AC output terminals which are generally connected with the motor.
V		
W		
PB	Braking resistor terminal	PB and (+) are connected to the external resistor.
(+)		
	Grounding terminal	Each machine has a standard PE terminal.

#### Note:

- Do not use an asymmetrically constructed motor cable. If there is a symmetrically constructed grounding conductor in the motor cable in addition to the conductive shield, connect the grounding conductor to the grounding terminal at the VFD and motor ends.
- Route the motor cable, input power cable and control cables separately.
- "T" terminal can not be wired in single-phase input.

### 3.2.3 Wiring of terminals in main circuit

- Connect the ground wire of the input power cable to the ground terminal (PE) of the VFD, and connect the 3PH input cable to the terminals R, S, and T, and fasten them up.
- Connect the ground wire of the motor cable to the ground terminal of the VFD, and connect the 3PH motor cable to the terminals U, V, and W, and fasten them up.
- Connect the brake resistor and other accessories that are equipped with cables to the specified positions.
- Fasten all the cables outside of the VFD mechanically, if possible.



## 3.2.4 Connection diagram of the control circuit

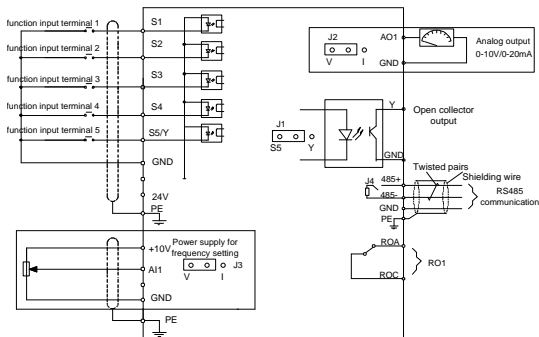

Figure 3-5 Connection diagram of the control circuit

## 3.2.5 Wiring diagram of control circuit

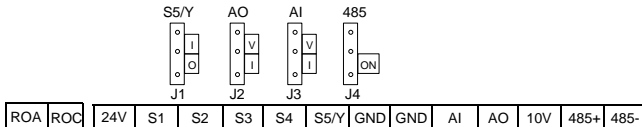

Figure 3-6 Control circuit wiring

Description	
ROA	RO relay output
ROC	Contactor capability: 3A/AC250V,1A/DC30V
+10V	Local power supply +10V
AI	1. Input range: AI voltage and curren: 0 - 10V/0 - 20mA and switch by J3 2. Input impedance:voltage input: 20kΩ; current input: 500Ω 3. Resolution: the minimum one is 5mV when 10V corresponds to 50Hz 4. Deviation ±1%, 25° C Notel: Keyboard potentiometer set AI1parameters of and AI terminal set AI2 parameters
24V	Local +24V power supply, 100mA
GND	+10V reference zero potential
AO	1. Output range:0 - 10V or 0 - 20mA 2. The voltage or the current output is depended on J2

3. Deviation $\pm 1\%$ , 25°C		
S1	Switch input 1	1. Internal impedance:3.3k $\Omega$ 2. 0 - 4V corresponds to low electric level input and 7 - 30V corresponds to high electric level input 3. Max input frequency:1kHz 4. All are programmable digital input terminal. User can set the terminal function through function codes.
S2	Switch input 2	
S3	Switch input 3	
S4	Switch input 4	
S5	Switch input 5	Common terminal for S5/Y and switch by J1 Note : S5 and Y can not be used at the same time
Y	Digital output terminal	
485+	485 communication interface and 485 differential signal interface	
485-	If it is the standard 485 communication interface, please use twisted pairs or shield cable.	

### 3.3 Wiring protection

#### 3.3.1 Protect the VFD and input power cable in short-circuit situations

Protect the VFD and input power cable in short circuit situations and against thermal overload.

Arrange the protection according to the following guidelines.

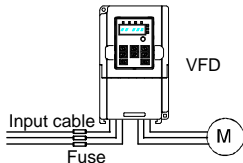

Figure 3-7 Fuse configuration

**Note:** Select the fuse as the manual indicated. The fuse will protect the input power cable from damage in short-circuit situations. It will protect the surrounding devices when the internal of the VFD is short circuited.

#### 3.3.2 Protecting the motor and motor cables

The VFD protects the motor and motor cable in a short-circuit situation when the motor cable is dimensioned according to the rated current of the VFD. No additional protection devices are needed.



- ◇ If the VFD is connected to multiple motors, a separate thermal overload switch or a circuit breaker must be used for protecting each cable and motor. These devices may require a separate fuse to cut off the short-circuit current.

#### 3.3.3 Implementing a bypass connection

It is necessary to set power frequency and variable frequency conversion circuits for the assurance of continuous normal work of the VFD if faults occur in some significant situations.

In some special situations, for example, if it is only used in soft start, the VFD can be converted into power frequency running after starting and some corresponding bypass should be added.



⚡ Never connect the supply power to the VFD output terminals U, V and W. Power line voltage applied to the output can result in permanent damage to the VFD.

If frequent shifting is required, employ mechanically connected switches or contactors to ensure that the motor terminals are not connected to the AC power line and VFD output terminals simultaneously.

## Chapter 4 Keypad

### 4.1 Keypad description

The keypad is used to control Goodrive10 series VFDs, read the state data and adjust parameters. If you need to use the keypad in another place rather than on the VFD, use a network cable with a standard RJ45 crystal head as the extension cable.

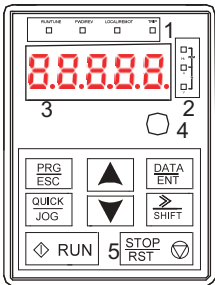
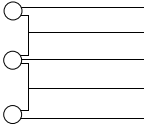









Figure 4-1 Keypad

**Note:** Fix the external keypad with M3 screws or the installation bracket. The installation bracket is optional.

No.	Name	Description	
1	State LED	RUN/TUNE	LED off means that the VFD is in the stopping state; LED blinking means the VFD is in the parameter autotune state; LED on means the VFD is in the running state.
		FWD/REV	FED/REV LED LED off means the VFD is in the forward rotation state; LED on means the VFD is in the reverse rotation state
		LOCAL/REMOT	LED for keypad operation, terminals operation and remote communication control LED off means that the VFD is in the keypad operation state; LED blinking means the VFD is in the terminals operation state; LED on means the VFD is in the remote communication control state.
		TRIP	LED for faults LED on when the VFD is in the fault state; LED off in normal state; LED blinking means the VFD is in the overload pre-alarm state.
2	Unit LED	Mean the unit displayed currently	

No.	Name	Description																																																																					
			Hz	Frequency unit																																																																			
	A		Current unit																																																																				
	V		Voltage unit																																																																				
	RPM		Rotating speed unit																																																																				
	%		Percentage																																																																				
3	Code displaying zone	5-figure LED display displays various monitoring data and alarm code such as set frequency and output frequency.																																																																					
		<table border="1"> <thead> <tr> <th>Displayed word</th> <th>Corresponding word</th> <th>Displayed word</th> <th>Corresponding word</th> <th>Displayed word</th> <th>Corresponding word</th> </tr> </thead> <tbody> <tr> <td>0</td> <td>0</td> <td>1</td> <td>1</td> <td>2</td> <td>2</td> </tr> <tr> <td>3</td> <td>3</td> <td>4</td> <td>4</td> <td>5</td> <td>5</td> </tr> <tr> <td>6</td> <td>6</td> <td>7</td> <td>7</td> <td>8</td> <td>8</td> </tr> <tr> <td>9</td> <td>9</td> <td>A</td> <td>A</td> <td>b</td> <td>B</td> </tr> <tr> <td>C</td> <td>C</td> <td>d</td> <td>d</td> <td>E</td> <td>E</td> </tr> <tr> <td>F</td> <td>F</td> <td>H</td> <td>H</td> <td>I</td> <td>I</td> </tr> <tr> <td>L</td> <td>L</td> <td>N</td> <td>N</td> <td>n</td> <td>n</td> </tr> <tr> <td>o</td> <td>o</td> <td>P</td> <td>P</td> <td>r</td> <td>r</td> </tr> <tr> <td>S</td> <td>S</td> <td>t</td> <td>t</td> <td>U</td> <td>U</td> </tr> <tr> <td>v</td> <td>v</td> <td>.</td> <td>.</td> <td>-</td> <td>-</td> </tr> </tbody> </table>	Displayed word	Corresponding word	Displayed word	Corresponding word	Displayed word	Corresponding word	0	0	1	1	2	2	3	3	4	4	5	5	6	6	7	7	8	8	9	9	A	A	b	B	C	C	d	d	E	E	F	F	H	H	I	I	L	L	N	N	n	n	o	o	P	P	r	r	S	S	t	t	U	U	v	v	.	.	-	-			
Displayed word	Corresponding word	Displayed word	Corresponding word	Displayed word	Corresponding word																																																																		
0	0	1	1	2	2																																																																		
3	3	4	4	5	5																																																																		
6	6	7	7	8	8																																																																		
9	9	A	A	b	B																																																																		
C	C	d	d	E	E																																																																		
F	F	H	H	I	I																																																																		
L	L	N	N	n	n																																																																		
o	o	P	P	r	r																																																																		
S	S	t	t	U	U																																																																		
v	v	.	.	-	-																																																																		
4	Digital potentiometer	Corresponds to AI1.																																																																					
5	Buttons		Programming key	Enter or escape from the first level menu and remove the parameter quickly																																																																			
			Entry key	Enter the menu step-by-step Confirm parameters																																																																			
			UP key	Increase data or function code progressively																																																																			
			DOWN key	Decrease data or function code progressively																																																																			
			Right-shift key	Move right to select the displaying parameter circularly in stopping and running mode. Select the parameter modifying digit during the parameter modification																																																																			
			Run key	This key is used to operate on the VFD in key operation mode																																																																			
			Stop/Reset key	This key is used to stop in running state and it is limited by function code P07.04 This key is used to reset all control modes in the fault alarm state																																																																			

No.	Name	Description	
			Quick key The function of this key is confirmed by function code P07.02.



## 4.2 Keypad display

The keypad displaying state of Goodrive10 series VFDs is divided into stopping state parameter, running state parameter, function code parameter editing state and fault alarm state and so on.

### 4.2.1 Displayed state of stopping parameter



When the VFD is in the stopping state, the keypad will display stopping parameters which is shown in figure 4-2.

In the stopping state, various kinds of parameters can be displayed. Select the parameters to be displayed or not by P07.07. See the instructions of P07.07 for the detailed definition of each bit.

In the stopping state, there are 14 stopping parameters can be selected to be displayed or not. They are: set frequency, bus voltage, input terminals state, output terminals state, PID reference, PID feedback, AI1, AI2 and the current stage of multi-stage speeds, pulse counting value. P07.07 can select the parameter to be displayed or not by bit and  /SHIFT can shift the parameters form left to right,  (P07.02=2) can shift the parameters form right to left.

### 4.2.2 Displayed state of running parameters





After the VFD receives valid running commands, the VFD will enter into the running state and the keypad will display the running parameters. RUN/TUNE LED on the keypad is on, while the FWD/REV is determined by the current running direction which is shown as figure 4-2.

In the running state, there are 22 parameters can be selected to be displayed or not. They are: running frequency, set frequency, bus voltage, output voltage, output torque, PID reference, PID feedback, input terminals state, output terminals state, and the current stage of multi-stage speeds, pulse counting value, AI1, AI2, percentage of motor overload, percentage of VFD overload, linear speed. P07.05 and P07.06 can select the parameter to be displayed or not by bit and  /SHIFT can shift the parameters form left to right,  (P07.02=2) can shift the parameters from right to left.

### 4.2.3 Displayed state of fault

If the VFD detects the fault signal, it will enter into the fault pre-alarm displaying state. The keypad will display the fault code by flicking. The TRIP LED on the keypad is on, and the fault reset can be operated by the  on the keypad, control terminals or communication commands.

### 4.2.4 Displayed state of function codes editing

In the state of stopping, running or fault, press  to enter into the editing state (if there is a password, see P07.00 ).The editing state is displayed on two classes of menu, and the order is: function code group/function code number→function code parameter, press  into the displayed state of function parameter. On this state, press  to save the parameters or press  to escape.

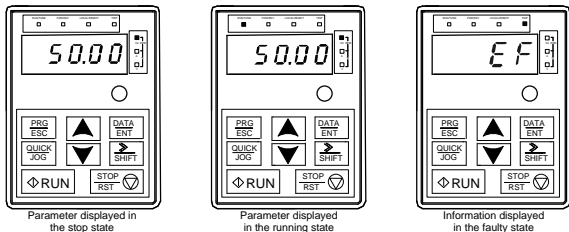

Figure 4-2 Displayed states

### 4.3 Keypad operation

Operate the VFD via operation panel. See the detailed structure description of function codes in the brief diagram of function codes.

#### 4.3.1 How to modify the function codes of the VFD

The VFD has three levels menu, which are:

1. Group number of function code (first-level menu)
2. Tab of function code (second-level menu)
3. Set value of function code (third-level menu)

Remarks: Press both the **PRG/ESC** and the **DATA/ENT** can return to the second-level menu from the third-level menu. The difference is: pressing **DATA/ENT** will save the set parameters into the control panel, and then return to the second-level menu with shifting to the next function code automatically; while pressing **PRG/ESC** will directly return to the second-level menu without saving the parameters, and keep staying at the current function code.

Under the third-level menu, if the parameter has no flickering bit, it means the function code cannot be modified. The possible reasons could be:

- 1) This function code is not modifiable parameter, such as actual detected parameter, operation records and so on;
- 2) This function code is not modifiable in running state, but modifiable in stop state.

Example: Set function code P00.01 from 0 to 1.

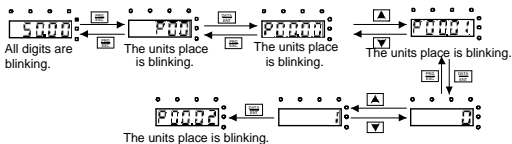

Note: When setting, **STOP** and **▲** + **▼** can be used to shift and adjust

Figure 4-3 Sketch map of modifying parameters

### 4.3.2 How to set the password of the VFD

Goodrive10 series VFDs provide password protection function to users. Set P7.00 to gain the password and the password protection becomes valid instantly after quitting from the function code editing state. Press **PRG/ESC** again to the function code editing state, "0.0.0.0.0" will be displayed. Unless using the correct password, the operators cannot enter it.

Set P7.00 to 0 to cancel password protection function.

The password protection becomes valid instantly after retreating from the function code editing state. Press **PRG/ESC** again to the function code editing state, "0.0.0.0.0" will be displayed. Unless using the correct password, the operators cannot enter it.

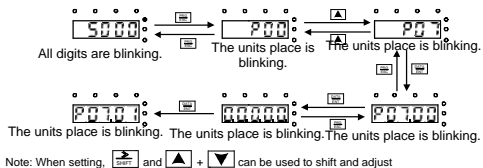

Figure 4-4 Sketch map of password setting

### 4.3.3 How to view the VFD state through function codes

Goodrive10 series VFDs provide group P17 as the state inspection group. Users can enter into P17 directly to watch the state.

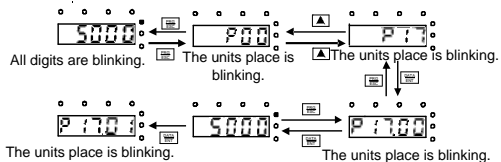

Figure 4-5 Sketch map of state watching



## Chapter 5 Function parameters

The function parameters of Goodrive10 series VFDs have been divided into 30 groups (P00–P29) according to the function, of which P18 - P28 are reserved. Each function group contains certain function codes applying 3-level menus. For example, "P08.08" means the eighth function code in the P8 group function, P29 group is factory reserved, and users are forbidden to access these parameters.

For the convenience of function codes setting, the function group number corresponds to the first level menu, the function code corresponds to the second level menu and the function code corresponds to the third level menu.

1. Below is the instruction of the function lists:

**The first column** "Function code":codes of function parameter group and parameters;

**The second column** "Name":full name of function parameters;

**The third column** "Detailed description of parameters":Detailed illustration of the function parameters

**The fourth column** "Default value":the original factory set value of the function parameter;

**The fifth column** "Modify": the modifying character of function codes (the parameters can be modified or not and the modifying conditions), below is the instruction:

"○": means the set value of the parameter can be modified on stop and running state;

"⊙": means the set value of the parameter can not be modified on the running state;

"●": means the value of the parameter is the real detection value which can not be modified.

Function code	Name	Detailed description of parameters	Default value	Modify
<b>P00 group Basic functions</b>				
P00.00	Speed control mode	2:SVPWM control (suitable for asynchronous motor) 2 is suitable in cases where it does not need high control accuracy, such as the load of fan and pump. One VFD can drive multiple motors. <b>Note:</b> Carry out motor parameter autotuning before adopting vector mode.	2	⊙
P00.01	Channel of running commands	Select the run command channel of the VFD. The control command of the VFD includes: start-up, stop, forward, reverse, jogging and fault reset. 0:Keypad running command channel("LOCAL/REMOT" light off) Carry out the command control by <b>RUN</b> , <b>STOP/RST</b> on the keypad. Set the multi-function key <b>QUICK/JOG</b> to <b>FWD/REV</b> shifting function (P07.02=3) to change the running direction; press <b>RUN</b> and <b>STOP/RST</b> simultaneously in running state to make the VFD coast to stop.	0	○

Function code	Name	Detailed description of parameters	Default value	Modify
		<p>1:Terminal running command channel ("LOCAL/REMOTE" flickering) Carry out the running command control by the forward rotation, reverse rotation and forward jogging and reverse jogging of the multi-function terminals</p> <p>2:Communication running command channel ("LOCAL/REMOTE" on); The running command is controlled by the upper monitor via communication</p>		
P00.03	Max. output frequency	<p>This parameter is used to set the maximum output frequency of the VFD. Users should pay attention to this parameter because it is the foundation of the frequency setting and the speed of acceleration and deceleration. Setting range: P00.04–400.00Hz</p>	50.00Hz	☉
P00.04	Upper limit of the running frequency	<p>The upper limit of the running frequency is the upper limit of the output frequency of the VFD which is lower than or equal to the maximum frequency. Setting range:P00.05–P00.03 (Max. output frequency)</p>	50.00Hz	☉
P00.05	Lower limit of the running frequency	<p>The lower limit of the running frequency is that of the output frequency of the VFD. The VFD runs at the lower limit frequency if the set frequency is lower than the lower limit one. <b>Note:</b> Max. output frequency <math>\geq</math> Upper limit frequency <math>\geq</math> Lower limit frequency Setting range:0.00Hz–P00.04 (Upper limit of the running frequency)</p>	0.00Hz	☉
P00.06	A frequency command selection	<p><b>Note:</b> Frequency A and frequency B cannot use the same frequency setting mode. The frequency source can be set by P00.09.</p>	0	○
P00.07	B frequency command selection	<p>0:Keypad data setting (correspond to the keyboard potentiometer) Modify the value of function code P00.10 (set the frequency by keypad) to modify the frequency by the keypad. 1:Analog AI1 setting (correspond to AI) 2:Analog AI2 setting Analog input terminal sets the frequency. There are 2 standard analog input terminal, of which AI1 is adjusted through digital potentiometer, AI2 (0 - 10V/0 - 20mA)can</p>	2	○

Function code	Name	Detailed description of parameters	Default value	Modify
		<p>be switched by the jumper.</p> <p><b>Note:</b> when AI2 selects 0 - 20mA input, 20mA corresponds to 10V.</p> <p>100.0% of the analog input corresponds to P00.03, -100.0% of the analog input corresponds to the reverse P00.03.</p> <p>6: Multi-stage speed running setting The VFD runs at multi-stage speed mode when P00.06=6 or P00.07=6. Set P05 to select the current running stage, and set P10 to select the current running frequency. The multi-stage speed has the priority when P00.06 or P00.07 does not equal to 6, but the setting stage can only be the 1-15 stage. The setting stage is 1-15 if P00.06 or P00.07 equals to 6.</p> <p>7: PID control setting The running mode of the VFD is process PID control when P00.06=7 or P00.07=7. It is necessary to set P09. The running frequency of the VFD is the value after PID effect. See P09 for the detailed information of the preset source, preset value, feedback source of PID.</p> <p>8:MODBUS communication setting The frequency is set by MODBUS communication. See P14 for detailed information.</p>		
P00.08	B frequency command reference	<p>0: Maximum output frequency, 100% of B frequency setting corresponds to the maximum output frequency</p> <p>1: A frequency command, 100% of B frequency setting corresponds to the maximum output frequency. Select this setting if it needs to adjust on the base of A frequency command</p>	1	<input type="radio"/>
P00.09	Combination type of the setting source	<p>0: A, the current frequency setting is A frequency command</p> <p>1: B, the current frequency setting is B frequency command</p> <p>2: A+B, the current frequency setting is A frequency command + B frequency command</p> <p>3: A-B, the current frequency setting is A frequency command - B frequency command</p> <p>4: Max (A, B): The bigger one between A frequency command and B frequency is the set frequency.</p> <p>5: Min (A, B): The lower one between A frequency command and B frequency is the set frequency.</p> <p><b>Note:</b>The combination manner can be shifted by P05(terminal function)</p>	0	<input type="radio"/>
P00.10	Keypad set frequency	When A and B frequency commands are selected as "keypad setting", this parameter will be the initial value of	50.00Hz	<input type="radio"/>

Function code	Name	Detailed description of parameters	Default value	Modify				
		VFD reference frequency Setting range:0.00 Hz–P00.03(the Max. frequency)						
P00.11	ACC time 1	ACC time means the time needed if the VFD speeds up from 0Hz to the Max. One (P00.03).	Depend on model	○				
P00.12	DEC time 1	DEC time means the time needed if the VFD speeds down from the Max. Output frequency to 0Hz (P00.03). Goodrive10 series VFDs define four groups of ACC/DEC time which can be selected by P05. The factory default ACC/DEC time of the VFD is the first group. Setting range of P00.11 and P00.12:0.0–3600.0s	Depend on model	○				
P00.13	Running direction selection	0: Runs at the default direction, the VFD runs in the forward direction. <b>FWD/REV</b> indicator is off. 1: Runs at the opposite direction, the VFD runs in the reverse direction. <b>FWD/REV</b> indicator is on. Modify the function code to shift the rotation direction of the motor. This effect equals to the shifting the rotation direction by adjusting either two of the motor lines (U, V and W). The motor rotation direction can be changed by <b>QUICK/JOG</b> on the keypad. Refer to parameter P07.02. <b>Note:</b> When the function parameter comes back to the default value, the motor's running direction will come back to the factory default state, too. In some cases it should be used with caution after commissioning if the change of rotation direction is disabled. 2: Forbid to run in reverse direction: It can be used in some special cases if the reverse running is disabled.	0	○				
P00.14	Carrier frequency setting	The relationship table of the motor type and carrier frequency: <table border="1" data-bbox="329 1093 774 1209"> <thead> <tr> <th>Motor type</th> <th>Factory value of carrier frequency</th> </tr> </thead> <tbody> <tr> <td>0.2–2.2kW</td> <td>4kHz</td> </tr> </tbody> </table>	Motor type	Factory value of carrier frequency	0.2–2.2kW	4kHz	Depend on model	○
Motor type	Factory value of carrier frequency							
0.2–2.2kW	4kHz							

Function code	Name	Detailed description of parameters	Default value	Modify																
		<table border="1"> <thead> <tr> <th>Carrier frequency</th> <th>Electro magnetic noise</th> <th>Noise and leakage current</th> <th>Heating eliminating</th> </tr> </thead> <tbody> <tr> <td>1kHz</td> <td>↑ High</td> <td>↑ Low</td> <td>↑ Low</td> </tr> <tr> <td>10kHz</td> <td></td> <td></td> <td></td> </tr> <tr> <td>15kHz</td> <td>↓ Low</td> <td>↓ High</td> <td>↓ High</td> </tr> </tbody> </table> <p>The advantage of high carrier frequency: ideal current waveform, little current harmonic wave and motor noise.</p> <p>The disadvantage of high carrier frequency: increasing the switch loss, increasing VFD temperature and the impact to the output capacity. The VFD needs to derate on high carrier frequency. At the same time, the leakage and electrical magnetic interference will increase.</p> <p>Applying low carrier frequency is contrary to the above, too low carrier frequency will cause unstable running, torque decreasing and surge.</p> <p>The manufacturer has set a reasonable carrier frequency when the VFD is in factory. In general, users do not need to change the parameter.</p> <p>When the frequency used exceeds the default carrier frequency, the VFD needs to derate 10% for each additional 1kHz carrier frequency.</p> <p>Setting range:1.0–15.0kHz</p>	Carrier frequency	Electro magnetic noise	Noise and leakage current	Heating eliminating	1kHz	↑ High	↑ Low	↑ Low	10kHz				15kHz	↓ Low	↓ High	↓ High		
Carrier frequency	Electro magnetic noise	Noise and leakage current	Heating eliminating																	
1kHz	↑ High	↑ Low	↑ Low																	
10kHz																				
15kHz	↓ Low	↓ High	↓ High																	
P00.16	AVR function selection	<p>0:Invalid</p> <p>1:Valid during the whole process</p> <p>The auto-adjusting function of the VFD can cancel the impact on the output voltage of the VFD because of the bus voltage fluctuation.</p>	1	○																
P00.18	Function restore parameter	<p>0:No operation</p> <p>1:Restore the default value</p> <p>2:Clear fault records</p> <p><b>Note:</b> The function code will restore to 0 after finishing the operation of the selected function code.</p> <p>Restoring to the default value will cancel the user password, please use this function with caution.</p>	0	◎																

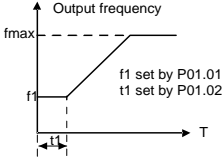
Function code	Name	Detailed description of parameters	Default value	Modify
<b>P01 group Start and stop control</b>				
P01.00	Start mode	0:Start-up directly:start from the starting frequency P01.01 1:Start-up after DC braking: start the motor from the starting frequency after DC braking (set the parameter P01.03 and P01.04). It is suitable in the cases where reverse rotation may occur to the low inertia load during starting.	0	☉
P01.01	Starting frequency of direct start-up	Starting frequency of direct start-up means the original frequency during the VFD starting. See P01.02 for detailed information. Setting range: 0.00–50.00Hz	0.50Hz	☉
P01.02	Retention time of the starting frequency	Set a proper starting frequency to increase the torque of the VFD during starting. During the retention time of the starting frequency, the output frequency of the VFD is the starting frequency. And then, the VFD will run from the starting frequency to the set frequency. If the set frequency is lower than the starting frequency, the VFD will stop running and keep in the stand-by state. The starting frequency is not limited in the lower limit frequency.  Setting range: 0.0–50.0s	0.0s	☉
P01.03	The braking current before starting	The VFD will carry out DC braking at the braking current set before starting and it will speed up after the DC braking time. If the DC braking time is set to 0, the DC braking is invalid.	0.0%	☉
P01.04	The braking time before starting	The stronger the braking current, the bigger the braking power. The DC braking current before starting means the percentage of the rated current of the VFD. Setting range of P01.03: 0.0–100.0%	0.00s	☉

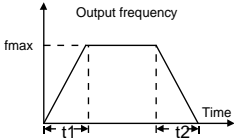
Function code	Name	Detailed description of parameters	Default value	Modify
		Setting range of P01.04: 0.0–50.0s		
P01.05	ACC/DEC selection	<p>The changing mode of the frequency during start-up and running.</p> <p>0: Linear type The output frequency increases or decreases linearly.</p> 	0	☉
P01.08	Stop selection	<p>0: Decelerate to stop: after the stop command becomes valid, the VFD decelerates to decrease the output frequency during the set time. When the frequency decreases to 0, the VFD stops.</p> <p>1: Coast to stop: after the stop command becomes valid, the VFD ceases the output immediately. And the load coasts to stop at the mechanical inertia.</p>	0	○
P01.09	Starting frequency of DC braking	Starting frequency of DC braking: start the DC braking when running frequency reaches starting frequency determined by P1.09.	0.00Hz	○
P01.10	Waiting time before DC braking	Waiting time before DC braking: VFDs block the output before starting the DC braking. After this waiting time, the DC braking will be started so as to prevent over-current fault caused by DC braking at high speed.	0.00s	○
P01.11	DC braking current	DC braking current: The value of P01.11 is the percentage of rated current of VFD. The bigger the DC braking current is, the greater the braking torque is.	0.0%	○
P01.12	DC braking time	DC braking time: The retention time of DC brake. If the time is 0, the DC brake is invalid. The VFD will stop at the set deceleration time.	0.00s	○

Function code	Name	Detailed description of parameters	Default value	Modify
		<p>Setting range of P01.09: 0.00Hz–P00.03            Setting range of P01.10: 0.0–50.0s            Setting range of P01.11: 0.0–100.0%            Setting range of P01.12: 0.0–50.0s</p>		
P01.13	Dead time of FWD/REV rotation	<p>During the procedure of switching FWD/REV rotation, set the threshold by P01.14, which is as the table below:</p> <p>Setting range: 0.0–3600.0s</p>	0.00s	○
P01.14	Switching between FWD/REV rotation	<p>Set the threshold point of the VFD:</p> <p>0: Switch after 0 frequency            1: Switch after the starting frequency            2: Switch after a delay time when the VFD stops</p>	0	◎
P01.15	Stopping speed	0.00–100.00Hz	1.00 Hz	◎
P01.18	Terminal running protection when powering on	<p>When the running command channel is the terminal control, the system will detect the state of the running terminal during powering on.</p> <p>0: The terminal running command is invalid when powering on. Even the running command is detected to be valid during powering on, the VFD won't run and the system keeps in the protection state until the running command is canceled and enabled again.</p>	0	○

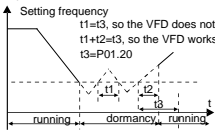

Function code	Name	Detailed description of parameters	Default value	Modify
		<p>1: The terminal running command is valid when powering on. If the running command is detected to be valid during powering on, the system will start the VFD automatically after the initialization.</p> <p><b>Note:</b> this function should be selected with cautions, or serious result may follow.</p>		
P01.19	The running frequency is lower than the lower limit one (valid if the lower limit frequency is above 0)	<p>This function code determines the running state of the VFD when the set frequency is lower than the lower-limit one.</p> <p>0: Run at the lower-limit frequency 1: Stop 2: Hibernation</p> <p>The VFD will coast to stop when the set frequency is lower than the lower-limit one. If the set frequency is above the lower limit one again and it lasts for the time set by P01.20, the VFD will come back to the running state automatically.</p>	0	☉
P01.20	Hibernation restore delay time	<p>This function code determines the hibernation delay time. When the running frequency of the VFD is lower than the lower limit one, the VFD will pause to stand by. When the set frequency is above the lower limit one again and it lasts for the time set by P01.20, the VFD will run automatically.</p>  <p>Setting range: 0.0–3600.0s (valid when P01.19=2)</p>	0.0s	○
P01.21	Restart after power off	<p>This function can enable the VFD start or not after the power off and then power on.</p> <p>0: Disabled 1: Enabled, if the starting need is met, the VFD will run automatically after waiting for the time defined by P01.22.</p>	0	○
P01.22	The waiting time of restart	<p>The function determines the waiting time before the automatic running of the VFD when powering off and then</p>	1.0s	○

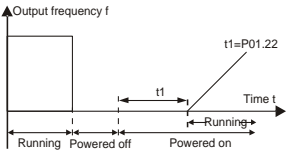
Function code	Name	Detailed description of parameters	Default value	Modify
	after power off	powering on.  Setting range: 0.0–3600.0s (valid when P01.21=1)		
P01.23	Start delay time	The function determines the brake release after the running command is given, and the VFD is in a stand-by state and wait for the delay time set by P01.23 Setting range: 0.0–60.0s	0.0s	<input type="radio"/>
P01.24	Delay of the stopping speed	Setting range: 0.0–100.0 s	0.0s	<input type="radio"/>
<b>P02 group Motor parameters</b>				
P02.01	Asynchronous motor rated power	0.1–3000.0kW	Depend on model	<input checked="" type="radio"/>
P02.02	Asynchronous motor rated frequency	0.01Hz–P00.03(the Max. frequency)	50.00Hz	<input checked="" type="radio"/>
P02.03	Asynchronous motor rated speed	1–36000rpm	Depend on model	<input checked="" type="radio"/>
P02.04	Asynchronous motor rated voltage	0–1200V	Depend on model	<input checked="" type="radio"/>
P02.05	Asynchronous motor rated current	0.8–6000.0A	Depend on model	<input checked="" type="radio"/>

Function code	Name	Detailed description of parameters	Default value	Modify
P02.06	Asynchronous motor stator resistor	0.001–65.535Ω	Depend on model	<input type="radio"/>
P02.07	Asynchronous motor rotor resistor	0.001–65.535Ω	Depend on model	<input type="radio"/>
P02.08	Asynchronous motor leakage inductance	0.1–6553.5mH	Depend on model	<input type="radio"/>
P02.09	Asynchronous motor mutual inductance	0.1–6553.5mH	Depend on model	<input type="radio"/>
P02.10	Asynchronous motor non-load current	0.1–6553.5A	Depend on model	<input type="radio"/>
P02.26	Motor overload protection	<p>0:No protection</p> <p>1: Common motor (with low speed compensation). Because the heat-releasing effect of the common motors will be weakened, the corresponding electric heat protection will be adjusted properly. The low speed compensation characteristic mentioned here means reducing the threshold of the overload protection of the motor whose running frequency is below 30Hz.</p> <p>2: Frequency conversion motor (without low speed compensation) Because the heat-releasing effect of the specific motors won't be impacted by the rotation speed, it is not necessary to adjust the protection value during low-speed running.</p>	2	<input checked="" type="radio"/>
P02.27	Motor overload protection	When P02.27=overload protection current of the motor/rated current of the motor	100.0%	<input type="radio"/>

Function code	Name	Detailed description of parameters	Default value	Modify
	coefficient	<p>So, the bigger the overload coefficient is, the shorter the reporting time of the overload fault is. When the overload coefficient <math>&lt; 110\%</math>, there is no overload protection. When <math>M=116\%</math>, protection is performed after motor overload lasts for 1 hour; when <math>M=150\%</math>, protection is performed after motor overload lasts for 12 minutes; when <math>M=180\%</math>, protection is performed after motor overload lasts for 5 minutes; when <math>M=200\%</math>, protection is performed after motor overload lasts for 60 seconds; and when <math>M \geq 400\%</math>, protection is performed immediately.</p> <p>Setting range: 20.0%–120.0%</p>		
<b>P04 group SVPWM control</b>				
P04.00	Motor V/F curve setting	<p>These function codes define the V/F curve of Goodrive10 motor to meet the need of different loads.</p> <p>0: Straight line V/F curve; applying to the constant torque load</p> <p>1: Multi-dots V/F curve</p>	0	☉
P04.01	Torque boost	Torque boost to the output voltage for the features of low frequency torque. P04.01 is for the Max. Output voltage $V_b$ .	0.0%	○
P04.02	Torque boost close	<p>P04.02 defines the percentage of closing frequency of manual torque to <math>f_b</math>.</p> <p>Torque boost should be selected according to the load. The bigger the load is, the bigger the torque is. Too big torque boost is inappropriate because the motor will run with over magnetic, and the current of the VFD will increase to add the temperature of the VFD and decrease the efficiency.</p> <p>When the torque boost is set to 0.0%, the VFD is automatic</p>	20.0%	○

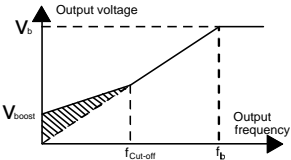
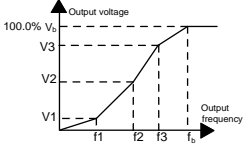
Function code	Name	Detailed description of parameters	Default value	Modify
		<p>torque boost.</p> <p>Torque boost threshold: below this frequency point, the torque boost is valid, but over this frequency point, the torque boost is invalid.</p>  <p>Setting range of P04.01:0.0%:(automatic)0.1%–10.0% Setting range of P04.02:0.0%–50.0%</p>		
P04.03	Motor V/F frequency point 1	 <p>When P04.00 =1, the user can set V//F curve through P04.03–P04.08.</p> <p>V/F is generally set according to the load of the motor.</p> <p>Note: <math>V1 &lt; V2 &lt; V3, f1 &lt; f2 &lt; f3</math>. Too high low frequency voltage will heat the motor excessively or damage. The VFD may occur the overcurrent speed or overcurrent protection.</p> <p>Setting range of P04.03: 0.00Hz–P04.05 Setting range of P04.04, P04.06 and P04.08 : 0.0%–110.0% Setting range of P04.05:P04.03– P04.07 Setting range of P04.07:P04.05–P02.02(the rated frequency of motor 1)</p>	0.00Hz	<input type="radio"/>
P04.04	Motor V/F voltage point 1		00.0%	<input type="radio"/>
P04.05	Motor V/F frequency point 2		00.00Hz	<input type="radio"/>
P04.06	Motor V/F voltage point 2		00.0%	<input type="radio"/>
P04.07	Motor V/F frequency point 3		00.00Hz	<input type="radio"/>
P04.08	Motor V/F voltage point 3		00.0%	<input type="radio"/>

Function code	Name	Detailed description of parameters	Default value	Modify
P04.09	Motor V/F slip compensation gain	<p>This function code is used to compensate the change of the rotation speed caused by load during compensation SVPWM control to improve the rigidity of the motor. It can be set to the rated slip frequency of the motor which is counted as below:</p> $\Delta f = f_b \cdot n \cdot p / 60$ <p>Of which, <math>f_b</math> is the rated frequency of the motor, its function code is P02.02; <math>n</math> is the rated rotating speed of the motor and its function code is P02.03; <math>p</math> is the pole pair of the motor. 100.0% corresponds to the rated slip frequency <math>\Delta f</math>.</p> <p>Note: no torque compensation for single-phase 220V VFDs</p> <p>Setting range: 0.0–200.0%</p>	380V: 100.0%	○
			220V:0%	
P04.10	Low frequency vibration control factor	<p>In the SVPWM control mode, current fluctuation may occur to the motor on some frequency, especially the motor with big power. The motor can not run stably or overcurrent may occur. These phenomena can be canceled by adjusting this parameter.</p> <p>Setting range of P04.10: 0–100</p> <p>Setting range of P04.11: 0–100</p> <p>Setting range of P04.12: 0.00Hz–P00.03(the Max. frequency)</p>	10	○
P04.11	High frequency vibration control factor		10	○
P04.12	Vibration control threshold		30.00 Hz	○
P04.26	Energy-saving operation	<p>0: No operation</p> <p>1: Automatic energy-saving</p> <p>The motor adjust the output voltage in non-load state automatically.</p>	0	◎
<b>P05 group Input terminals</b>				
P05.01	S1 terminal function selection	<p>0: No function</p> <p>1: Forward rotation operation</p> <p>2: Reverse rotation operation</p> <p>3: 3-wire control operation</p> <p>4: Forward rotation jogging</p> <p>5: Reverse rotation jogging</p>	1	◎
P05.02	S2 terminal function selection		4	◎

Function code	Name	Detailed description of parameters	Default value	Modify										
P05.03	S3 terminal function selection	6: Coast to stop 7: Fault reset 8: Operation pause	7	☉										
P05.04	S4 terminal function selection	9: External fault input 10:Increasing frequency setting(UP) 11:Decreasing frequency setting(DOWN) 12:Cancel the frequency change setting	0	☉										
P05.05	S5 terminal function selection	13:Shift between A setting and B setting 14:Shift between combination setting and A setting 15:Shift between combination setting and B setting 16:Multi-stage speed terminal 1 17:Multi-stage speed terminal 2 18:Multi-stage speed terminal 3 19:Multi- stage speed terminal 4 20:Multi- stage speed pause 21:ACC/DEC time option 1 25:PID control pause 26:Traverse Pause(stop at the current frequency) 27:Traverse reset(return to the center frequency) 28:Counter reset 30:ACC/DEC prohibition 31:Counter trigger 33:Cancel the frequency change setting temporarily 34:DC brake 36:Shift the command to the keypad 37:Shift the command to the terminals 38:Shift the command to the communication	0	☉										
P05.10	Polarity selection of the input terminals	The function code is used to set the polarity of the input terminals. Set the bit to 0, the input terminal is positive polarity. Set the bit to 1, the input terminal is negative polarity. <table border="1" style="margin-left: auto; margin-right: auto;"> <tr> <td style="text-align: center;">BIT4</td> <td style="text-align: center;">BIT3</td> <td style="text-align: center;">BIT2</td> <td style="text-align: center;">BIT1</td> <td style="text-align: center;">BIT0</td> </tr> <tr> <td style="text-align: center;">S5</td> <td style="text-align: center;">S4</td> <td style="text-align: center;">S3</td> <td style="text-align: center;">S2</td> <td style="text-align: center;">S1</td> </tr> </table> Setting range:0x000–0x1F	BIT4	BIT3	BIT2	BIT1	BIT0	S5	S4	S3	S2	S1	0x000	○
BIT4	BIT3	BIT2	BIT1	BIT0										
S5	S4	S3	S2	S1										
P05.11	Switch filter time	Set the sample filter time of S1–S5. If the interference is strong, increase the parameter to avoid the disoperation. 0.000–1.000s	0.010s	○										

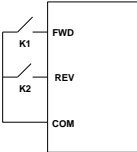
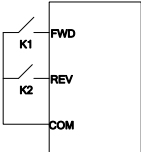
Function code	Name	Detailed description of parameters	Default value	Modify																																																				
P05.12	Virtual terminals setting	<p>Enable the input function of virtual terminals at the communication mode.</p> <p>0:Virtual terminals is invalid 1:MODBUS communication virtual terminals are valid</p>	0	⊙																																																				
P05.13	Terminals control running mode	<p>Set the operation mode of the terminals control</p> <p>0:2-wire control 1, comply the enable with the direction. This mode is widely used. It determines the rotation direction by the defined FWD and REV terminals command.</p> <div style="display: flex; align-items: center;">  <table border="1" style="margin-left: 20px;"> <thead> <tr> <th>FWD</th> <th>REV</th> <th>Running command</th> </tr> </thead> <tbody> <tr> <td>OFF</td> <td>OFF</td> <td>Stopping</td> </tr> <tr> <td>ON</td> <td>OFF</td> <td>Forward running</td> </tr> <tr> <td>OFF</td> <td>ON</td> <td>Reverse running</td> </tr> <tr> <td>ON</td> <td>ON</td> <td>Hold on</td> </tr> </tbody> </table> </div> <p>1:2-wire control 2: Separate the enable from the direction. FWD defined by this mode is the enabling ones.</p> <div style="display: flex; align-items: center;">  <table border="1" style="margin-left: 20px;"> <thead> <tr> <th>FWD</th> <th>REV</th> <th>Running command</th> </tr> </thead> <tbody> <tr> <td>OFF</td> <td>OFF</td> <td>Stopping</td> </tr> <tr> <td>ON</td> <td>OFF</td> <td>Forward running</td> </tr> <tr> <td>OFF</td> <td>ON</td> <td>Stopping</td> </tr> <tr> <td>ON</td> <td>ON</td> <td>Reverse running</td> </tr> </tbody> </table> </div> <p>The direction depends on the state of the defined REV.</p> <table border="1" style="width: 100%; text-align: center;"> <thead> <tr> <th>SIn</th> <th>REV</th> <th>Previous direction</th> <th>Current direction</th> </tr> </thead> <tbody> <tr> <td rowspan="2">ON</td> <td rowspan="2">OFF→ON</td> <td>Forward</td> <td>Reverse</td> </tr> <tr> <td>Reverse</td> <td>Forward</td> </tr> <tr> <td rowspan="2">ON</td> <td rowspan="2">ON→OFF</td> <td>Reverse</td> <td>Forward</td> </tr> <tr> <td>Forward</td> <td>Reverse</td> </tr> <tr> <td>ON→OFF</td> <td>ON</td> <td colspan="2" rowspan="2">Decelerate to stop</td> </tr> <tr> <td>OFF</td> <td>OFF</td> </tr> </tbody> </table> <p>2:3-wire control 1; Sin is the enabling terminal in this mode, and the running command is caused by FWD and the direction is controlled by REV. Sin is natural closed.</p>	FWD	REV	Running command	OFF	OFF	Stopping	ON	OFF	Forward running	OFF	ON	Reverse running	ON	ON	Hold on	FWD	REV	Running command	OFF	OFF	Stopping	ON	OFF	Forward running	OFF	ON	Stopping	ON	ON	Reverse running	SIn	REV	Previous direction	Current direction	ON	OFF→ON	Forward	Reverse	Reverse	Forward	ON	ON→OFF	Reverse	Forward	Forward	Reverse	ON→OFF	ON	Decelerate to stop		OFF	OFF	0	⊙
FWD	REV	Running command																																																						
OFF	OFF	Stopping																																																						
ON	OFF	Forward running																																																						
OFF	ON	Reverse running																																																						
ON	ON	Hold on																																																						
FWD	REV	Running command																																																						
OFF	OFF	Stopping																																																						
ON	OFF	Forward running																																																						
OFF	ON	Stopping																																																						
ON	ON	Reverse running																																																						
SIn	REV	Previous direction	Current direction																																																					
ON	OFF→ON	Forward	Reverse																																																					
		Reverse	Forward																																																					
ON	ON→OFF	Reverse	Forward																																																					
		Forward	Reverse																																																					
ON→OFF	ON	Decelerate to stop																																																						
OFF	OFF																																																							

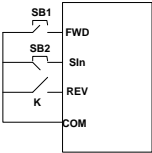
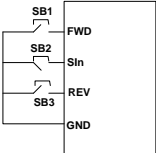

Function code	Name	Detailed description of parameters	Default value	Modify																				
		 <p>3:3-wire control 2; Sin is the enabling terminal on this mode, if set Si (i=1 - 5) to 3, when K is switched on, the control of FWD and REV is valid; when K is switched off, the control of FWD and REV is invalid. The VFD stops.</p>  <table border="1" data-bbox="303 704 798 911"> <thead> <tr> <th>SIn</th> <th>FWD</th> <th>REV</th> <th>Direction</th> </tr> </thead> <tbody> <tr> <td rowspan="2">ON</td> <td rowspan="2">OFF→ON</td> <td>ON</td> <td>Forward</td> </tr> <tr> <td>OFF</td> <td>Reverse</td> </tr> <tr> <td rowspan="2">ON</td> <td>ON</td> <td rowspan="2">OFF→ON</td> <td>Forward</td> </tr> <tr> <td>OFF</td> <td>Reverse</td> </tr> <tr> <td>ON→ OFF</td> <td></td> <td></td> <td>Decelerate to stop</td> </tr> </tbody> </table> <p>Note: for the 2-wire running mode, when <b>FWD/REV</b> terminal is valid, the VFD stop because of the stopping command from other sources, even the control terminal <b>FWD/REV</b> keeps valid; the VFD won't work when the stopping command is canceled. Only when <b>FWD/REV</b> is relaunched, the VFD can start again.</p>	SIn	FWD	REV	Direction	ON	OFF→ON	ON	Forward	OFF	Reverse	ON	ON	OFF→ON	Forward	OFF	Reverse	ON→ OFF			Decelerate to stop		
SIn	FWD	REV	Direction																					
ON	OFF→ON	ON	Forward																					
		OFF	Reverse																					
ON	ON	OFF→ON	Forward																					
	OFF		Reverse																					
ON→ OFF			Decelerate to stop																					
P05.14	S1 terminal switching on delay time	The function code defines the corresponding delay time of electrical level of the programmable terminals from switching on to switching off.	0.000s	○																				
P05.15	S1 terminal switching off delay time		0.000s	○																				

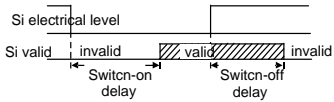
Function code	Name	Detailed description of parameters	Default value	Modify	
P05.16	S2 terminal switching on delay time	 <p>Setting range:0.000–50.000s</p>	0.000s	<input type="radio"/>	
P05.17	S2 terminal switching off delay time		0.000s	<input type="radio"/>	
P05.18	S3 terminal switching on delay time		0.000s	<input type="radio"/>	
P05.19	S3 terminal switching off delay time		0.000s	<input type="radio"/>	
P05.20	S4 terminal switching on delay time		0.000s	<input type="radio"/>	
P05.21	S4 terminal switching off delay time		0.000s	<input type="radio"/>	
P05.22	S5 terminal switching on delay time		0.000s	<input type="radio"/>	
P05.23	S5 terminal switching off delay time		0.000s	<input type="radio"/>	
P05.32	Lower limit of AI1		<p>The function code defines the relationship between the analog input voltage and its corresponding set value. If the analog input voltage beyond the set minimum or maximum input value, the VFD will count at the minimum or maximum one.</p> <p>When the analog input is the current input, the</p>	0.00V	<input type="radio"/>
P05.33	Corresponding setting of the lower limit of AI1			0.0%	<input type="radio"/>

Function code	Name	Detailed description of parameters	Default value	Modify
P05.34	Upper limit of AI1	corresponding voltage of 0–20mA is 0–10V. In different cases, the corresponding rated value of 100.0% is different. See the application for detailed information.	10.00V	<input type="radio"/>
P05.35	Corresponding setting of the upper limit of AI1	The figure below illustrates different applications:	100.0%	<input type="radio"/>
P05.36	AI1 input filter time		0.100s	<input type="radio"/>
P05.37	Lower limit of AI2		0.00V	<input type="radio"/>
P05.38	Corresponding setting of the lower limit of AI2	Input filter time: this parameter is used to adjust the sensitivity of the analog input. Increasing the value properly can enhance the anti-interference of the analog, but weaken the sensitivity of the analog input.	0.0%	<input type="radio"/>
P05.39	Upper limit of AI2	Note: AI2 can support 0–10V or 0–20mA input, when AI2 selects 0–20mA input, the corresponding voltage of 20mA is 5V.	10.00V	<input type="radio"/>
P05.40	Corresponding setting of the upper limit of AI2	Setting range of P05.32:0.00V–P05.34 Setting range of P05.33:-100.0%–100.0% Setting range of P05.34:P05.32–10.00V Setting range of P05.35:-100.0%–100.0% Setting range of P05.36:0.000s–10.000s Setting range of P05.37:0.00V–P05.39	100.0%	<input type="radio"/>
P05.41	AI2 input filter time	Setting range of P05.38:-100.0%–100.0% Setting range of P05.39:P05.37–10.00V Setting range of P05.40:-100.0%–100.0% Setting range of P05.41:0.000s–10.000s	0.100s	<input type="radio"/>
<b>P06 group Output terminals</b>				
P06.01	Y output selection	0:Invalid 1:On operation	0	<input type="radio"/>
P06.03	Relay RO output	2:Forward rotation operation 3:Reverse rotation operation 4: Jogging operation 5:The VFD fault	1	<input type="radio"/>

Function code	Name	Detailed description of parameters	Default value	Modify								
		6:Frequency degree test FDT1 7:Frequency degree test FDT2 8:Frequency arrival 9:Zero speed running 10:Upper limit frequency arrival 11:Lower limit frequency arrival 12:Ready for operation 14:Overload pre-alarm 15: Underload pre-alarm 16:Completion of simple PLC stage 17:Completion of simple PLC cycle 18:Setting count value arrival 19:Defined count value arrival 20:External fault valid 22:Running time arrival 23:MODBUS communication virtual terminals output										
P06.05	Polarity of output terminals	The function code is used to set the pole of the output terminal. When the current bit is set to 0, input terminal is positive. When the current bit is set to 1, input terminal is negative. <table border="1" style="margin: 10px auto;"> <tr> <td>BIT3</td> <td>BIT2</td> <td>BIT1</td> <td>BIT0</td> </tr> <tr> <td>Reserved</td> <td>RO1</td> <td>Reserved</td> <td>Y</td> </tr> </table> Setting range:00-0F	BIT3	BIT2	BIT1	BIT0	Reserved	RO1	Reserved	Y	00	○
BIT3	BIT2	BIT1	BIT0									
Reserved	RO1	Reserved	Y									
P06.06	Y switching on delay time	0.000-50.000s	0.000s	○								
P06.07	Y switching off delay time	0.000-50.000s	0.000s	○								
P06.10	RO switching on delay time	The function code defines the corresponding delay time of the electrical level change during the programmable terminal switching on and off.	0.000s	○								
P06.11	RO switching off delay time	RO electric level                      Setting range :0.000-50.000s	0.000s	○								
P06.14	AO output	0:Running frequency	0	○								

Function code	Name	Detailed description of parameters	Default value	Modify
		1:Set frequency 2:Ramp reference frequency 3:Running rotation speed (relative to twice the rotating speed of the motor) 4:Output current (relative to twice the rated current of the VFD) 5:Output current (relative to twice the rated current of the motor) 6:Output voltage (relative to 1.5 times the rated voltage of the VFD) 7:Output power (relative to twice the rated power of the motor) 8:Set torque value (relative to twice the rated torque of the motor) 9:Output torque 10:Analog AI1 input value 11:Analog AI2 input value 14:MODBUS communication set value 1 15:MODBUS communication set value 2		
P06.17	Lower limit of AO output	The above function codes define the relative relationship between the output value and analog output. When the output value exceeds the range of set maximum or minimum output, it will count according to the low-limit or upper-limit output. When the analog output is current output, 1mA equals to 0.5V. In different cases, the corresponding analog output of 100% of the output value is different.	0.0%	<input type="radio"/>
P06.18	Corresponding AO output to the lower limit		0.00V	<input type="radio"/>
P06.19	Upper limit of AO output		100.0%	<input type="radio"/>
P06.20	The corresponding AO output to the upper limit		10.00V	<input type="radio"/>
P06.21	AO output filter time		Setting range of P06.17 0.0%–P06.19 Setting range of P06.18 0.00V–10.00V Setting range of P06.19 P06.17–100.0%	0.000s

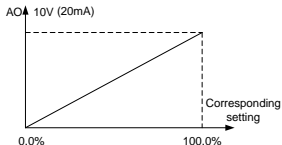

Function code	Name	Detailed description of parameters	Default value	Modify
		Setting range of P06.20 0.00V–10.00V Setting range of P06.21 0.000s–10.000s		
<b>P07 group Human-machine interface</b>				
P07.00	User's password	<p>0–65535</p> <p>The password protection will be valid when setting any non-zero number.</p> <p>00000: Clear the previous user's password, and make the password protection invalid.</p> <p>After the user's password becomes valid, if the password is incorrect, users cannot enter the parameter menu. Only correct password can make the user check or modify the parameters. Please remember all users' passwords.</p> <p>Retreat editing state of the function codes and the password protection will become valid in 1 minute. If the password is available, press <b>PRG/ESC</b> to enter into the editing state of the function codes, and then "0.0.0.0.0" will be displayed. Unless input right password, the operator can not enter into it.</p> <p>Note: restoring to the default value can clear the password, please use it with caution.</p>	0	○
P07.02	<b>QUICK/JOG</b> function	<p>0: No function</p> <p>1: Jogging running. Press <b>QUICK/JOG</b> to start jogging running.</p> <p>2: Shift the display state by the shifting key. Press <b>QUICK/JOG</b> to shift the displayed function code from right to left.</p> <p>3: Shift between forward rotations and reverse rotations. Press <b>QUICK/JOG</b> to shift the direction of the frequency commands. This function is only valid in the keypad commands channels.</p> <p>4: Clear UP/DOWN settings. Press <b>QUICK/JOG</b> to clear the set value of UP/DOWN.</p> <p>5: Coast to stop. Press <b>QUICK/JOG</b> to coast to stop.</p> <p>6: Shift the running commands source. Press <b>QUICK/JOG</b> to shift the running commands source.</p> <p>7: Quick commission mode(committee according to the</p>	1	◎

Function code	Name	Detailed description of parameters	Default value	Modify
		non-factory parameter) Note: Press <b>QUICK/JOG</b> to shift between forward rotation and reverse rotation, the VFD does not record the state after shifting during powering off. The VFD will run according to parameter P00.13 during next powering on.		
P07.03	<b>QUICK/JOG</b> the shifting sequence selection of running command	When P07.02=6, set the shifting sequence of running command channels. 0:Keypad control→terminals control →communication control 1:Keypad control←→terminals control 2:Keypad control←→communication control 3:Terminals control←→communication control	0	○
P07.04	<b>STOP/RST</b> stop function	Select the stop function by <b>STOP/RST</b> . <b>STOP/RST</b> is valid in any state for the fault reset. 0:Only valid for the panel control 1:Both valid for panel and terminals control 2:Both valid for panel and communication control 3:Valid for all control modes	0	○
P07.05	The parameter selection1 of running state	0x0000–0xFFFF BIT0:running frequency (Hz on) BIT1:set frequency(Hz flickering) BIT2:bus voltage (Hz on) BIT3:output voltage(V on) BIT4:output current(A on) BIT5:running rotation speed (rpm on) BIT6:output power(% on) BIT7:output torque(% on) BIT8:PID reference(% flickering) BIT9:PID feedback value(% on) BIT10:input terminals state BIT11:output terminals state BIT12:torque set value(% on) BIT13:pulse counter value BIT14:length value BIT15:current stage in multi-stage speed	0x03FF	○

Function code	Name	Detailed description of parameters	Default value	Modify
P07.06	The parameter selection 2 of running state	0x0000–0xFFFF BIT0: analog AI1 value (V on) BIT1: analog AI2 value (V on) BIT4: motor overload percentage (% on) BIT5: the VFD overload percentage (% on) BIT6: ramp frequency reference value(Hz on) BIT7: linear speed	0x0000	
P07.07	The parameter selection of the stop state	0x0000–0xFFFF BIT0:set frequency(Hz on, frequency flickering slowly) BIT1:bus voltage (V on) BIT2:input terminals state BIT3:output terminals state BIT4:PID reference (% flickering) BIT5:PID feedback value(% on) BIT7:analog AI1 value(V on) BIT8:analog AI2 value(V on) BIT11:current stage in multi-stage speed BIT12:pulse counters	0x00FF	○
P07.08	Frequency display coefficient	0.01–10.00 Displayed frequency=running frequency* P07.08	1.00	○
P07.09	Rotation speed coefficient	0.1–999.9% Mechanical rotation speed =120*displayed running frequency×P07.09/motor pole pairs	100.0%	○
P07.10	Linear speed displayed coefficient	0.1–999.9% Linear speed= Mechanical rotation speed×P07.10	1.0%	○
P07.11	Reserved			●
P07.12	Inverter module temperature	-20.0–120.0°C		●
P07.13	Software version	1.00–655.35		●



Function code	Name	Detailed description of parameters	Default value	Modify
P07.14	Local accumulative running time	0-65535h		●
P07.18	The rated power of the VFD	0.4-3000.0kW		●
P07.19	The rated voltage of the VFD	50-1200V		●
P07.20	The rated current of the VFD	0.1-6000.0A		●
P07.21	Factory bar code 1	0x0000-0xFFFF		●
P07.22	Factory bar code 2	0x0000-0xFFFF		●
P07.23	Factory bar code 3	0x0000-0xFFFF		●
P07.24	Factory bar code 4	0x0000-0xFFFF		●
P07.25	Factory bar code 5	0x0000-0xFFFF		●
P07.26	Factory bar code 6	0x0000-0xFFFF		●
P07.27	Current fault type	0:No fault 4:OC1 5:OC2		●

Function code	Name	Detailed description of parameters	Default value	Modify
P07.28	Previous fault type	6:OC3 7:OV1 8:OV2 9:OV3 10:UV		●
P07.29	Previous 2 fault type	11:Motor overload (OL1) 12: VFD overload (OL2)		●
P07.30	Previous 3 fault type	15:Overheat of the rectifier module(OH1) 16:Overheat fault of the inverter module (OH2) 17:External fault(EF)		●
P07.31	Previous 4 fault type	18:485 communication fault(CE) 21:EEPROM operation fault(EEP) 22:PID response offline fault(PIDE)		●
P07.32	Previous 5 fault type	24:Running time arrival(END) 25:Electrical overload(OL3) 36: Undervoltage fault(LL)		●
P07.33	Current fault running frequency		0.00Hz	●
P07.34	Ramp reference frequency at current fault		0.00Hz	●
P07.35	Output voltage at current fault		0V	●
P07.36	Output current at current fault		0.0A	●
P07.37	Bus voltage at current fault		0.0V	●
P07.38	Highest temperature at current fault		0.0°C	●
P07.39	Input terminal		0	●

Function code	Name	Detailed description of parameters	Default value	Modify
	state at current fault			
P07.40	Output terminal state at current fault		0	●
P07.41	Previous fault running frequency		0.00Hz	●
P07.42	Ramp reference frequency at previous fault		0.00Hz	●
P07.43	Output voltage at the previous fault		0V	●
P07.44	The output current at the previous fault		0.0A	●
P07.45	Bus voltage at the previous fault		0.0V	●
P07.46	Highest temperature at the previous fault		0.0° C	●
P07.47	Input terminals state at the previous fault		0	●
P07.48	Output terminals state at the previous fault		0	●

Function code	Name	Detailed description of parameters	Default value	Modify
P07.49	Previous 2 fault running frequency		0.00Hz	●
P07.50	Ramp reference frequency at the previous 2 faults		0.00Hz	●
P07.51	Output current at the previous 2 faults		0V	●
P07.52	Output current at the previous 2 fault		0.0A	●
P07.53	Bus voltage at the previous 2 fault		0.0V	●
P07.54	Highest temperature at previous 2 fault		0.0° C	●
P07.55	Input terminals state at previous 2 fault		0	●
P07.56	Output terminals state at previous 2 fault		0	●
<b>P08 group Enhanced function</b>				
P08.00	ACC time 2	Refer to P00.11 and P00.12 for detailed definition. Goodrive10 series define four groups of ACC/DEC time which can be selected by P5 group. The first group of ACC/DEC time is the factory default one.	Depend on model	○
P08.01	DEC time 2		Depend on model	○

Function code	Name	Detailed description of parameters	Default value	Modify
		Setting range:0.0–3600.0s		
P08.06	Jogging running frequency	This parameter is used to define the reference frequency during jogging. Setting range: 0.00Hz –P00.03(the Max. frequency)	5.00Hz	<input type="radio"/>
P08.07	Jogging running ACC time	The jogging ACC time means the time needed if the VFD runs from 0Hz to the Max. Frequency.	Depend on model	<input type="radio"/>
P08.08	Jogging running DEC time	The jogging DEC time means the time needed if the VFD goes from the Max. Frequency (P0.03) to 0Hz. Setting range:0.0–3600.0s	Depend on model	<input type="radio"/>
P08.15	Traverse range	This function applies to the industries where traverse and convolution function are required such as textile and chemical fiber.	0.0%	<input type="radio"/>
P08.16	Sudden jumping frequency range	The traverse function means that the output frequency of the VFD is fluctuated with the set frequency as its center. The route of the running frequency is illustrated as below, of which the traverse is set by P08.15 and when P08.15 is set as 0, the traverse is 0 with no function.	0.0%	<input type="radio"/>
P08.17	Traverse boost time		5.0s	<input type="radio"/>
P08.18	Traverse declining time	<p>Traverse range: The traverse running is limited by upper and low frequency.</p> <p>The traverse range relative to the center frequency: traverse range AW = center frequencyxtraverse range P08.15.</p> <p>Sudden jumping frequency=traverse range AWxsudden jumping frequency range P08.16. When run at the traverse set frequency, the value which is relative to the sudden jumping frequency.</p> <p>The raising time of the traverse frequency: The time from the lowest point to the highest one.</p>	5.0s	<input type="radio"/>

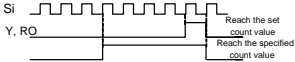
Function code	Name	Detailed description of parameters	Default value	Modify
		<p>The declining time of the traverse frequency: The time from the highest point to the lowest one.</p> <p>Setting range of P08.15: 0.0–100.0%(relative to the set frequency)</p> <p>Setting range of P08.16: 0.0–50.0%(relative to the traverse range)</p> <p>Setting range of P08.17: 0.1–3600.0s</p> <p>Setting range of P08.18: 0.1–3600.0s</p>		
P08.25	Setting counting value	The counter works by the input pulse signals of the HDI terminals.	0	<input type="radio"/>
P08.26	Given counting value	<p>When the counter achieves a given number, the multi-function output terminals will output the signal of "fixed counting number arrival" and the counter go on working; when the counter achieves a setting number, the multi-function output terminals will output the signal of "setting counting number arrival", the counter will clear all numbers and stop to recount before the next pulse.</p> <p>The setting counting value P08.26 should be no more than the setting counting value P08.25.</p> <p>The function is illustrated as below:</p>  <p>Setting range of P08.25:P08.26–65535</p> <p>Setting range of P08.26:0–P08.25</p>	0	<input type="radio"/>
P08.27	Setting running time	<p>Pre-set running time of the VFD. When the accumulative running time achieves the set time, the multi-function digital output terminals will output the signal of "running time arrival".</p> <p>Setting range:0–65535min</p>	0m	<input type="radio"/>
P08.28	Time of fault reset	The time of the fault reset: set the fault reset time by selecting this function. If the reset time exceeds this set value, the VFD will stop for the fault and wait to be repaired.	0	<input type="radio"/>
P08.29	Interval time of automatic fault reset	The interval time of the fault reset: The interval between the time when the fault occurs and the time when the reset action occurs.	1.0s	<input type="radio"/>

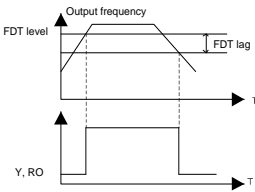
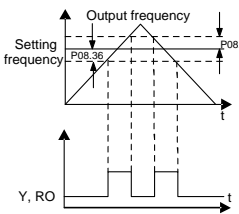
Function code	Name	Detailed description of parameters	Default value	Modify
		Setting range of P08.28:0-10 Setting range of P08.29:0.1-3600.0s		
P08.32	FDT electrical level detection value	When the output frequency exceeds the corresponding frequency of FDT electrical level, the multi-function digital output terminals will output the signal of "frequency level detect FDT" until the output frequency decreases to a value lower than (FDT electrical level—FDT retention detection value) the corresponding frequency, the signal is invalid. Below is the waveform diagram:	50.00Hz	<input type="radio"/>
P08.33	FDT retention detection value	 <p>Setting range of P08.32: 0.00Hz~P00.03(the Max. frequency) Setting range of P08.33: 0.0~100.0%(FDT electrical level)</p>	5.0%	<input type="radio"/>
P08.36	Amplitude value for frequency arrival detection	When the output frequency is among the below or above range of the set frequency, the multi-function digital output terminal will output the signal of "frequency arrival", see the diagram below for detailed information:	0.00Hz	<input type="radio"/>
		 <p>Setting range:0.00Hz~P00.03(the Max. frequency)</p>		

Function code	Name	Detailed description of parameters	Default value	Modify
P08.37	Energy Braking enable	This parameter is used to control the internal braking pipe. 0:Disabled 1:Enabled Note: Only applied to internal braking pipe.	0	<input type="radio"/>
P08.38	Energy Braking threshold voltage	After setting the original bus voltage to brake the energy, adjust the voltage appropriately to brake the load. The factory changes with the voltage level. Setting range:200.0 – 2000.0V	220V voltage: 380.0V	<input type="radio"/>
			380V voltage: 700.0V	
P08.39	Cooling fan running mode	0:Rated running mode 1:The fan keeps on running after power on	0	<input type="radio"/>
P08.40	PWM selection	0x0000–0x0021 LED ones: PWM mode selection 0: PWM mode 1, Three-phase modulation and two-phase modulation 1: PWM mode 2, Three-phase modulation LED tens: low-speed carrier frequency limit 0: low-speed carrier frequency limit mode 1; when the carrier frequency exceeds 1k at low speed, limit to 1k. 1: low-speed carrier frequency limit mode 2; when the carrier frequency exceeds 2k at low speed, limit to 2k. 2: No limit for the carrier frequency at low speed	0x01	<input checked="" type="radio"/>
P08.41	Over commission selection	0:Invalid 1:Valid	1	<input checked="" type="radio"/>
P08.42	Keypad data control setting	0x000–0x1223 LED ones: frequency enable selection 0: ^/∨ keys adjustments are valid 1:Reserved 2: ^/∨ keys adjustments are invalid 3: Reserved LED tens: frequency control selection 0:Only valid when P00.06=0 or P00.07=0 1:Valid for all frequency setting manner 2:Invalid for multi-stage speed when multi-stage speed has the priority LED hundreds: action selection during stopping	0x0000	<input type="radio"/>



Function code	Name	Detailed description of parameters	Default value	Modify
		0:Setting is valid 1:Valid during running, cleared after stopping 2:Valid during running, cleared after receiving the stop command LED thousands: $\wedge/\vee$ keys and digital potentiometer Integral function 0:The Integral function is valid 1:The Integral function is invalid		
P08.44	UP/DOWN terminals control setting	0x00–0x221 LED ones: frequency enabling selection 0:UP/DOWN terminals setting valid 1:UP/DOWN terminals setting invalid LED tens: frequency control selection 0:Only valid when P00.06=0 or P00.07=0 1:All frequency means are valid 2:When the multi-stage are priority, it is invalid to the multi-stage LED hundreds: action selection when stop 0:Setting valid 1:Valid in the running, clear after stop 2:Valid in the running, clear after receiving the stop commands	0x000	<input type="radio"/>
P08.45	UP terminal frequency increasing integral ratio	0.01–50.00 Hz/s	0.50 Hz/s	<input type="radio"/>
P08.46	DOWN terminal frequency decreasing integral ratio	0.01–50.00 Hz/s	0.50 Hz/s	<input type="radio"/>
P08.47	Action selection for frequency settings on power off	0x000–0x111 LED ones: Action for digital adjustable frequency on power off 0: Save on power off 1: Clear on power off LED tens: Action for MODBUS frequency setting on power off 0: Save on power off 1: Clear on power off	0x000	<input type="radio"/>

Function code	Name	Detailed description of parameters	Default value	Modify
		LED hundreds: Action for other-mode frequency setting on power off 0: Save on power off 1: Clear on power off		
P08.50	Magnetic flux braking	This function code is used to enable magnetic flux. 0: Invalid. 100 – 150: the bigger the coefficient, the bigger the braking strength. This VFD can slow down the motor by increasing the magnetic flux. The energy generated by the motor during braking can be transformed into heat energy by increasing the magnetic flux. The VFD monitors the state of the motor continuously even during the magnetic flux period. So the magnetic flux can be used in the motor stop, as well as to change the rotation speed of the motor. Its other advantages are: Brake immediately after the stop command. It does not need to wait the magnetic flux weaken. The cooling is better. The current of the stator other than the rotor increases during magnetic flux braking, while the cooling of the stator is more valid than the rotor.	0	●
<b>P09 group PID control</b>				
P09.00	PID reference source selection	When the frequency command selection (P00.06, P00.07) is 7, the running mode of the VFD is procedure PID control. The parameter determines the target reference channel during the PID procures. 0:Keypad digital reference(P09.01) 1:Analog channel AI1 reference 2:Analog channel AI2 reference 5:Multi-stage speed set 6:MODBUS communication set The setting target of procedure PID is a relative one, 100% of the setting equals to 100% of the response of the controlled system. The system is calculated according to the relative value (0–100.0%). Note: Multi-stage speed reference, it is realized by setting P10	0	○
P09.01	Keypad PID	When P09.00=0, set the parameter whose basic value is	0.0%	○

Function code	Name	Detailed description of parameters	Default value	Modify
	preset	the feedback value of the system. Setting range:-100.0%–100.0%		
P09.02	PID feedback source selection	Select the PID channel by the parameter. 1:Analog channel AI2 feedback 4:MODBUS communication feedback Note: The reference channel and the feedback channel can not coincide, otherwise, PID can not control validly.	1	<input type="radio"/>
P09.03	PID output feature selection	0: PID output is positive: When the feedback signal exceeds the PID reference value, the output frequency of the VFD will decrease to balance the PID. For example, the strain PID control during wrapup 1: PID output is negative: When the feedback signal is stronger than the PID reference value, the output frequency of the VFD will increase to balance the PID. For example, the strain PID control during wrapdown	0	<input type="radio"/>
P09.04	Proportional gain (Kp)	The function is applied to the proportional gain P of PID input. P determines the strength of the whole PID adjuster. The parameter of 100 means that when the offset of PID feedback and reference value is 100%, the adjusting range of PID adjuster is the Max. Frequency (ignoring integral function and differential function). Setting range:0.00–100.00	1.00	<input type="radio"/>
P09.05	Integral time(Ti)	This parameter determines the speed of PID adjuster to carry out integral adjustment on the deviation of PID feedback and reference. When the deviation of PID feedback and reference is 100%, the integral adjuster works continuously after the time (ignoring the proportional effect and differential effect) to achieve the Max. Frequency (P00.03) or the Max. Voltage (P04.31). Shorter the integral time, stronger is the adjustment Setting range: 0.01–10.00s	0.10s	<input type="radio"/>
P09.06	Differential time(Td)	This parameter determines the strength of the change ratio when PID adjuster carries out integral adjustment on the deviation of PID feedback and reference. If the PID feedback changes 100% during the time, the adjustment of integral adjuster (ignoring the proportional effect and differential effect) is the Max. Frequency	0.00s	<input type="radio"/>

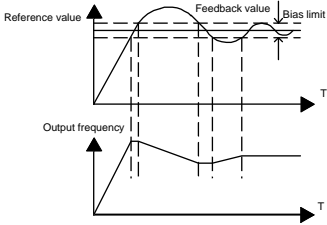
Function code	Name	Detailed description of parameters	Default value	Modify
		(P00.03). Longer the integral time, stronger is the adjusting. Setting range: 0.00–10.00s		
P09.07	Sampling cycle(T)	This parameter means the sampling cycle of the feedback. The modulator calculates in each sampling cycle. The longer the sampling cycle is, the slower the response is. Setting range: 0.00–100.00s	0.10s	<input type="radio"/>
P09.08	PID control deviation limit	As shown in the diagram below, PID adjuster stops to work during the deviation limit. Set the function properly to adjust the accuracy and stability of the system.  Setting range:0.0–100.0%	0.0%	<input type="radio"/>
P09.09	Output upper limit of PID	These parameters are used to set the upper and lower limit of the PID adjuster output. 100.0 % corresponds to Max. Frequency	100.0%	<input type="radio"/>
P09.10	Output lower limit of PID	Setting range of P09.09: P09.10–100.0% Setting range of P09.10: -100.0%–P09.09	0.0%	<input type="radio"/>
P09.11	Feedback offline detection value	Set the PID feedback offline detection value, when the detection value is smaller than or equal to the feedback offline detection value, and the lasting time exceeds the set value in P09.12, the VFD will report "PID feedback offline fault" and the keypad will display PIDE.	0.0%	<input type="radio"/>
P09.12	Feedback offline detection time		1.0s	<input type="radio"/>

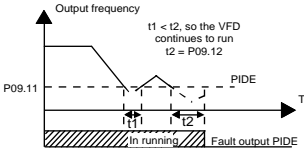
Function code	Name	Detailed description of parameters	Default value	Modify
		 <p>Setting range of P09.11: 0.0–100.0%</p> <p>Setting range of P09.12: 0.0–3600.0s</p>		
P09.13	PID adjustment selection	<p>0x00–0x11</p> <p>LED ones:</p> <p>0: Keep on integral adjustment when the frequency achieves the upper and low limit; the integration shows the change between the reference and the feedback unless it reaches the internal integral limit. When the trend between the reference and the feedback changes, it needs more time to offset the impact of continuous working and the integration will change with the trend.</p> <p>1: Stop integral adjustment when the frequency reaches the upper and low limit. If the integration keeps stable, and the trend between the reference and the feedback changes, the integration will change with the trend quickly.</p> <p>LED tens:</p> <p>0: The same with the setting direction; if the output of PID adjustment is different from the current running direction, the internal will output 0 forcedly.</p> <p>1: Opposite to the setting direction</p>	0x00	<input type="radio"/>
<b>P10 group Simple PLC and multi-step speed control</b>				
P10.02	Multi-step speed 0	<p>100.0% of the frequency setting corresponds to the Max. Frequency P00.03.</p> <p>When selecting simple PLC running, set P10.02–P10.33 to define the running frequency and direction of all steps.</p>	0.0%	<input type="radio"/>
P10.04	Multi-step speed 1	<p>Note: The symbol of multi-step determines the running direction of simple PLC. The negative value means reverse</p>	0.0%	<input type="radio"/>

Function code	Name	Detailed description of parameters	Default value	Modify
P10.06	Multi-step speed 2	rotation.	0.0%	<input type="radio"/>
P10.08	Multi-step speed 3	<p>Multi-step speeds are in the range of <math>-f_{\max}</math>~<math>f_{\max}</math> and it can be</p> <p>Goodrive10 series VFDs can set 16 steps speed, selected by the combination of multi-step terminals 1~4, corresponding to the speed 0 to speed 15.</p> <p>When terminal1= terminal 2= terminal 3= terminal 4=OFF, the frequency input manner is selected via code P00.06 or P00.07. When not all terminals are off, it runs at multi-step which takes precedence of keypad, analog value, high-speed pulse, PLC, communication frequency input. Select at most 16 steps speed via the combination code of terminals 1, 2, 3, and 4.</p> <p>The start-up and stopping of multi-step running is determined by function code P00.06, the relationship between terminals 1, 2, 3, and 4 and multi-step speed is as following:</p>	0.0%	<input type="radio"/>
P10.10	Multi-step speed 4		0.0%	<input type="radio"/>
P10.12	Multi-step speed 5		0.0%	<input type="radio"/>
P10.14	Multi-step speed 6		0.0%	<input type="radio"/>
P10.16	Multi-step speed 7		0.0%	<input type="radio"/>
P10.18	Multi-step speed 8		0.0%	<input type="radio"/>
P10.20	Multi-step speed 9		0.0%	<input type="radio"/>
P10.22	Multi-step speed 10		0.0%	<input type="radio"/>
P10.24	Multi-step speed 11		0.0%	<input type="radio"/>
P10.26	Multi-step speed 12		0.0%	<input type="radio"/>
P10.28	Multi-step speed 13		0.0%	<input type="radio"/>
P10.30	Multi-step speed 14		0.0%	<input type="radio"/>

Function code	Name	Detailed description of parameters	Default value	Modify								
P10.32	Multi-step speed 15	Terminal 1	OFF	ON	OFF	ON	OFF	ON	OFF	ON	0.0%	○
		Terminal 2	OFF	OFF	ON	ON	OFF	OFF	ON	ON		
		Terminal 3	OFF	OFF	OFF	OFF	ON	ON	ON	ON		
		Terminal 4	OFF	OFF	OFF	OFF	OFF	OFF	OFF	OFF		
		Step	0	1	2	3	4	5	6	7		
		Terminal 1	OFF	ON	OFF	ON	OFF	ON	OFF	ON		
		Terminal 2	OFF	OFF	ON	ON	OFF	OFF	ON	ON		
		Terminal 3	OFF	OFF	OFF	OFF	ON	ON	ON	ON		
		Terminal 4	ON	ON	ON	ON	ON	ON	ON	ON		
		step	8	9	10	11	12	13	14	15		
				Setting range of P10.(2n,1<n<17): -100.0–100.0%								
<b>P11 group Protection parameters</b>												
P11.01	Sudden power loss frequency decreasing function selection	0: Disable 1: Enable	0	○								
P11.02	Frequency decreasing ratio of sudden power loss	<p>Setting range: 0.00Hz/s–P00.03 (the Max. frequency)</p> <p>After the power loss of the grid, the bus voltage drops to the sudden frequency-decreasing point, the VFD begin to decrease the running frequency at P11.02, to make the VFD generate power again. The returning power can maintain the bus voltage to ensure a rated running of the VFD until the recovery of power.</p> <table border="1"> <tr> <td>Voltage degree</td> <td>220V</td> <td>380V</td> </tr> <tr> <td>Frequency-decreasing point of sudden power loss</td> <td>260V</td> <td>460V</td> </tr> </table> <p><b>Note:</b></p> <p>1. Adjust the parameter properly to avoid the stopping</p>	Voltage degree	220V	380V	Frequency-decreasing point of sudden power loss	260V	460V	10.00Hz/s	○		
Voltage degree	220V	380V										
Frequency-decreasing point of sudden power loss	260V	460V										

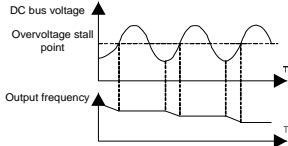
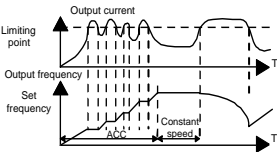
Function code	Name	Detailed description of parameters	Default value	Modify
		caused by VFD protection during the switching of the grid. 2. Disable input phase loss protection to enable this function.		
P11.03	Overvoltage speed loss protection	0:Disabled 1:Enabled 	1	<input type="radio"/>
P11.04	Overvoltage speed loss voltage protection	120–150%(standard bus voltage)(380V)	136%	<input type="radio"/>
		120–150%(standard bus voltage)(220V)	120%	
P11.05	Current limit action selection	The actual increasing ratio is less than the ratio of output frequency because of the big load during ACC running. It is necessary to take measures to avoid overcurrent fault and the VFD trips.	1	<input checked="" type="radio"/>
P11.06	Automatic current limit level	During the running of the VFD, this function will detect the output current and compare it with the limit level defined in P11.06. If it exceeds the level, the VFD will run at stable frequency in ACC running, or the VFD will derate to run during the constant running. If it exceeds the level continuously, the output frequency will keep on decreasing to the lower limit. If the output current is detected to be lower than the limit level, the VFD will accelerate to run.	160.0%	<input checked="" type="radio"/>
P11.07	The decreasing ratio during current limit	 Setting range of P11.05:	10.00Hz/s	<input checked="" type="radio"/>



Function code	Name	Detailed description of parameters	Default value	Modify
		0:current limit invalid 1:current limit valid Setting range of P11.06:50.0–200.0% Setting range of P11.07:0.00–50.00Hz/s		
P11.08	Overload pre-alarm of the motor or the VFD	The output current of the VFD or the motor is above P11.09 and the lasting time is beyond P11.10, overload pre-alarm will be output.	0x000	<input type="radio"/>
P11.09	Overload pre-alarm test level		150%	<input type="radio"/>
P11.10	Overload pre-alarm detection time	Setting range of P11.08: Enable and define the overload pre-alarm of the VFD or the motor. Setting range: 0x000–0x131 LED ones: 0:Overload pre-alarm of the motor, comply with the rated current of the motor 1:Overload pre-alarm of the VFD, comply with the rated current of the VFD LED tens: 0:The VFD continues to work after underload pre-alarm 1:The VFD continues to work after underload pre-alarm and the VFD stops to run after overload fault 2: The VFD continues to work after overload pre-alarm and the VFD stops to run after underload fault 3. The VFD stops when overloading or underloading. LED hundreds : 0:Detection all the time 1:Detection in constant running	1.0s	<input type="radio"/>

Function code	Name	Detailed description of parameters	Default value	Modify
		Setting range of P11.09: P11.11–200% Setting range of P11.10: 0.1–60.0s		
P11.11	Detection level of the underload pre-alarm	If the VFD current or the output current is lower than P11.11, and its lasting time is beyond P11.12, the VFD will output underload pre-alarm.	50%	<input type="radio"/>
P11.12	Detection time of the underload pre-alarm	Setting range of P11.11: 0–P11.09 Setting range of P11.12: 0.1–60.0s	1.0s	<input type="radio"/>
P11.13	Output terminal action selection during fault	Select the action of fault output terminals on undervoltage and fault reset. 0x00–0x11 LED ones: 0:Action under fault undervoltage 1:No action under fault undervoltage LED tens: 0:Action during the automatic reset 1:No action during the automatic reset	0x00	<input type="radio"/>
<b>P14 group Serial communication</b>				
P14.00	Local communication address	Setting range:1–247 When the master is writing the frame, the communication address of the slave is set to 0; the broadcast address is the communication address. All slaves on the MODBUS fieldbus can receive the frame, but the slave doesn't answer. The communication address of the drive is unique in the communication net. This is the fundamental for the point to point communication between the upper monitor and the drive. <b>Note:</b> The address of the slave cannot set to 0.	1	<input type="radio"/>

Function code	Name	Detailed description of parameters	Default value	Modify
P14.01	Baud rate	<p>Set the digital transmission speed between the upper monitor and the VFD.</p> <p>0:1200BPS 1:2400BPS 2:4800BPS 3:9600BPS 4:19200BPS 5:38400BPS</p> <p><b>Note:</b> The baud rate between the upper monitor and the VFD must be the same. Otherwise, the communication is not applied. The bigger the baud rate, the quicker the communication speed.</p>	4	<input type="radio"/>
P14.02	Digital bit checkout setting	<p>The data format between the upper monitor and the VFD must be the same. Otherwise, the communication is not applied.</p> <p>0: No check (N,8,1)for RTU 1: Even check (E,8,1) for RTU 2: Odd check (O,8,1) for RTU 3:No check (N,8,2) for RTU 4: Even check (E,8,2) for RTU 5: Odd check(O,8,2) for RTU</p>	1	<input type="radio"/>
P14.03	Communication response delay	<p>0–200ms</p> <p>It means the interval time between the interval time when the drive receive the data and sent it to the upper monitor. If the answer delay is shorter than the system processing time, then the answer delay time is the system processing time, if the answer delay is longer than the system processing time, then after the system deal with the data, waits until achieving the answer delay time to send the data to the upper monitor.</p>	5	<input type="radio"/>
P14.04	Communication overtime fault time	<p>0.0(invalid),0.1–60.0s</p> <p>When the function code is set as 0.0, the communication overtime parameter is invalid.</p>	0.0s	<input type="radio"/>

Function code	Name	Detailed description of parameters	Default value	Modify
		<p>When the function code is set as non-zero, if the interval time between two communications exceeds the communication overtime, the system will report "485 communication faults" (CE).</p> <p>Generally, set it as invalid; set the parameter in the continuous communication to monitor the communication state.</p>		
P14.05	Transmission fault processing	<p>0:Alarm and stop freely</p> <p>1:No alarm and continue to run</p> <p>2:No alarm and stop according to the stop means(only under the communication control)</p> <p>3:No alarm and stop according to the stop means(under all control modes)</p>	0	○
P14.06	Communication processing action selection	<p>0x00–0x11</p> <p>LED ones:</p> <p>0: Operation with response: the drive will respond to all reading and writing commands of the upper monitor.</p> <p>1: Operation without response; The drive only responds to the reading command other than the writing command of the drive. The communication efficiency can be increased by this method.</p> <p>LED tens:(reserved)</p>	0x00	○
<b>P17 group State viewing function</b>				
P17.00	Set frequency	<p>Display current set frequency of the VFD</p> <p>Range: 0.00Hz–P00.03</p>	0.00Hz	●
P17.01	Output frequency	<p>Display current output frequency of the VFD</p> <p>Range: 0.00Hz–P00.03</p>	0.00Hz	●
P17.02	Ramp reference frequency	<p>Display current ramp reference frequency of the VFD</p> <p>Range: 0.00Hz–P00.03</p>	0.00Hz	●

Function code	Name	Detailed description of parameters	Default value	Modify
P17.03	Output voltage	Display current output voltage of the VFD Range: 0–1200V	0V	●
P17.04	Output current	Display current output current of the VFD Range: 0.0–5000.0A	0.0A	●
P17.05	The rotation speed of the motor	Display the rotation speed of the motor. Range: 0–65535RPM	0 RPM	●
P17.08	Motor power	Display current power of the motor. Setting range: -300.0%–300.0%(the rated current of the motor)	0.0%	●
P17.09	Output torque	Display the current output torque of the VFD. Range: -250.0–250.0%	0.0%	●
P17.11	DC bus voltage	Display current DC bus voltage of the VFD Range: 0.0–2000.0V	0V	●
P17.12	Switch input terminals state	Display current Switch input terminals state of the VFD Range: 0000–00FF	0	●
P17.13	Switch output terminals state	Display current Switch output terminals state of the VFD Range: 0000–000F	0	●
P17.14	Digital adjustment	Display the adjustment through the keypad of the VFD. Range : 0.00Hz–P00.03	0.00V	●
P17.18	Counting value	Display the current counting number of the VFD. Range: 0–65535	0	●

Function code	Name	Detailed description of parameters	Default value	Modify
P17.19	AI1 input voltage	Display analog AI1 input signal Range: 0.00–10.00V	0.00V	●
P17.20	AI2 input voltage	Display analog AI2 input signal Range: 0.00–10.00V	0.00V	●
P17.23	PID reference value	Display PID reference value Range: -100.0–100.0%	0.0%	●
P17.24	PID response value	Display PID response value Range: -100.0–100.0%	0.0%	●
P17.25	Power factor of the motor	Display the current power factor of the motor Range: -1.00–1.00		●
P17.26	Current running time	Display the current running time of the VFD. Range:0–65535min	0m	●
P17.27	Current stage of the multi-stage speed	Display simple PLC and the current stage of the multi-stage speed Range: 0–15	0	●
P17.36	Output torque	Display the output torque. Positive value is in the electromotion state, and negative is in the power generating state. Range : -3000.0Nm–3000.0Nm	0	●
P17.37	Counting value of motor overload	0 – 100 (100: OL1)		●

## Chapter 6 Fault tracking

### 6.1 Fault prevention

This chapter describes how to perform preventive maintenance on the VFD.

#### 6.1.1 Maintenance intervals

If installed in an appropriate environment, the VFD requires very little maintenance. The table lists the routine maintenance intervals recommended by INVT.

Checking part		Checking item	Checking method	Criterion
Ambient environment		Check the ambient temperature, humidity and vibration and ensure there is no dust, gas, oil fog and water drop.	Visual examination and instrument test	Conforming to the manual
		Ensure there are no tools or other foreign or dangerous objects	Visual examination	There are no tools or dangerous objects.
Voltage		Ensure the main circuit and control circuit are normal.	Measurement by multimeter	Conforming to the manual
Keypad		Ensure the display is clear enough	Visual examination	The characters are displayed normally.
		Ensure the characters are displayed totally	Visual examination	Conforming to the manual
Main circuit	Commonly used	Ensure the screws are tightened security	Tighten up	NA
		Ensure there is no distortion, crackles, damage or color-changing caused by overheating and aging to the machine and insulator.	Visual examination	NA
		Ensure there is no dust and dirtiness	Visual examination	NA <b>Note:</b> if the color of the copper blocks change, it does not mean that there is something wrong with the features.
	The lead of the conductors	Ensure that there is no distortion or color-changing of the conductors caused by overheating.	Visual examination	NA

Checking part	Checking item	Checking method	Criterion
	Ensure that there are no crackles or color-changing of the protective layers.	Visual examination	NA
Terminals seat	Ensure that there is no damage	Visual examination	NA
Filter capacitors	Ensure that there is no weeping, color-changing, crackles and cassis expansion.	Visual examination	NA
	Ensure the safety valve is in the right place.	Estimate the usage time according to the maintenance or measure the static capacity.	NA
	If necessary, measure the static capacity.	Measure the capacity by instruments.	The static capacity is above or equal to the original value *0.85.
Resistors	Ensure whether there is replacement and splitting caused by overheating.	Smelling and visual examination	NA
	Ensure that there is no offline.	Visual examination or remove one ending to coagulate or measure with multimeters	The resistors are in $\pm 10\%$ of the standard value.
Transformers and reactors	Ensure there is no abnormal vibration, noise and smelling,	Hearing, smelling and visual examination	NA
Electromagnetism contactors and relays	Ensure whether there is vibration noise in the workrooms.	Hearing	NA
	Ensure the contactor is good enough.	Visual examination	NA
Control circuit	Ensure there is no loose screws and contactors.	Fasten up	NA
	Ensure there is no smelling and color-changing.	Smelling and visual examination	NA
	Ensure there are no crackles, damage distortion and rust.	Visual examination	NA



Checking part		Checking item	Checking method	Criterion
		Ensure there is no weeping and distortion to the capacitors.	Visual examination or estimate the usage time according to the maintenance information	NA
Cooling system	Cooling fan	Estimate whether there is abnormal noise and vibration.	Hearing and Visual examination or rotate with hand	Stable rotation
		Estimate there is no losses screw.	Tighten up	NA
		Ensure there is no color-changing caused by overheating.	Visual examination or estimate the usage time according to the maintenance information	NA
	Ventilating duct	Ensure whether there is stuff or foreign objection in the cooling fan, air vent.	Visual examination	NA

### 6.1.2 Cooling fan

The VFD's cooling fan has a minimum life span of 25,000 operating hours. The actual life span depends on the VFD usage and ambient temperature.

The operating hours can be found through P07.14 (accumulative hours of the VFD).

Fan failure can be predicted by the increasing noise from the fan bearings. If the VFD is operated in a critical part of a process, fan replacement is recommended once these symptoms appear. Replacement fans are available from INVT.

	<p>⚡ Read and follow the instructions in chapter <i>Safety Precautions</i>. Ignoring the instructions would cause physical injury or death, or damage to the equipment.</p>
--	---

1. Stop the VFD and disconnect it from the AC power source and wait for at least the time designated on the VFD.
2. Lever the fan holder off the drive frame with a screwdriver and lift the hinged fan holder slightly upward from its front edge.
3. Disconnect the fan cable.
4. Remove the fan holder from the hinges.
5. Install the new fan holder including the fan in reverse order. Keep the wind direction of the fan consistent with that of the VFD, as shown below:
6. Restore power.

### 6.1.3 Capacitors

#### Reforming the capacitors

The DC bus capacitors must be reformed according to the operation instruction if the VFD has been stored for a long time. The storing time is counted from the producing date other than the delivery data which has been marked in the serial number of the VFD.

Time	Operational principle
Storing time less than 1 year	Operation without charging
Storing time 1-2 years	Connect with the power for 1 hour before first ON command
Storing time 2-3 years	Use power surge to charge for the VFD <ul style="list-style-type: none"> <li>• Add 25% rated voltage for 30 minutes</li> <li>• Add 50% rated voltage for 30 minutes</li> <li>• Add 75% rated voltage for 30 minutes</li> <li>• Add 100% rated voltage for 30 minutes</li> </ul>
Storing time more than 3 years	Use power surge to charge for the VFD <ul style="list-style-type: none"> <li>• Add 25% rated voltage for 2 hours</li> <li>• Add 50% rated voltage for 2 hours</li> <li>• Add 75% rated voltage for 2 hours</li> <li>• Add 100% rated voltage for 2 hours</li> </ul>

The method of using power surge to charge for the VFD:

The right selection of Power surge depends on the supply power of the VFD. Single phase 220V AC/2A power surge applied to the VFD with single/three-phase 220V AC as its input voltage. All DC bus capacitors charge at the same time because there is one rectifier.

High-voltage VFD needs enough voltage (for example, 380V) during charging. The small capacitor power (2A is enough) can be used because the capacitor nearly does not need current when charging.

#### Change electrolytic capacitors

	<p>⚡ Read and follow the instructions in chapter <i>Safety Precautions</i>. Ignoring the instructions may cause physical injury or death, or damage to the equipment.</p>
--	---

Change electrolytic capacitors if the working hours of electrolytic capacitors in the VFD are above 35000. Please contact with the local INVT offices or dial our national service hotline (400-700-9997) for detailed operation.

### 6.1.4 Power cable

	<p>⚡ Read and follow the instructions in chapter <i>Safety Precautions</i>. Ignoring the instructions may cause physical injury or death, or damage to the equipment.</p>
--	---

1. Stop the drive and disconnect it from the power line. Wait for at least the time designated on the VFD.
2. Check the tightness of the power cable connections.
3. Restore power.

## 6.2 Fault rectification



- ✧ Only qualified electricians are allowed to maintain the VFD. Read the safety instructions in chapter Safety precautions before working on the VFD.

### 6.2.1 Alarm and fault indications

Fault is indicated by LEDs. See **Operation Procedure**. When **TRIP** light is on, an alarm or fault message on the panel display indicates abnormal VFD state. P07.27 - P07.32 record the latest 6 fault type and P07.33 - P07.56 record the operation data of the latest 3 fault type. Using the information reference in this chapter, most alarm and fault cause can be identified and corrected. If not, contact with the INVT office.

### 6.2.2 Fault reset

The VFD can be reset by pressing the keypad key **STOP/RS1**, through digital input, or by switching the power light. When the fault has been removed, the motor can be restarted.

### 6.2.3 Fault instruction and solution

Do as the following after the VFD fault:

1. Check to ensure there is nothing wrong with the keypad. If not, please contact with the local INVT office.
2. If there is nothing wrong, please check P07 and ensure the corresponding recorded fault parameters to confirm the real state when the current fault occurs by all parameters.
3. See the following table for detailed solution and check the corresponding abnormal state.
4. Eliminate the fault and ask for relative help.
5. Check to eliminate the fault and carry out fault reset to run the VFD.

Fault code	Fault type	Possible cause	What to do
OC1	Over-current when acceleration	1. The acceleration or deceleration is too fast.	1. Increase the ACC time
OC2	Over-current when deceleration	2. The voltage of the grid is too low.	2. Check the input power
OC3	Over-current when constant speed running	3. The power of the VFD is too low.	3. Select the VFD with a larger power
		4. The load transients or is abnormal.	4. Check if the load is short circuited (the grounding short circuited or the wire short circuited) or the rotation is not smooth.
		5. The grounding is short circuited or the output is phase loss.	5. Check the output configuration.
		6. There is strong external interference.	6. Check if there is strong interference.
OV1	Over-voltage when acceleration	1. The input voltage is abnormal.	1. Check the input power
OV2	Over-voltage when deceleration	2. There is large energy feedback.	2. Check if the DEC time of the load is too short or the VFD starts during the rotation of the

OV3	Over-voltage when constant speed running		motor or it needs to add the dynamic braking components.
UV	DC bus Under-voltage	The voltage of the power supply is too low.	Check the input power of the supply line
OL1	Motor overload	<ol style="list-style-type: none"> <li>1. The voltage of the power supply is too low.</li> <li>2. The motor setting rated current is incorrect.</li> <li>3. The motor stall or load transients is too strong.</li> </ol>	<ol style="list-style-type: none"> <li>1. Check the power of the supply line</li> <li>2. Reset the rated current of the motor</li> <li>3. Check the load and adjust the torque lift</li> </ol>
OL2	VFD overload	<ol style="list-style-type: none"> <li>1. The acceleration is too fast</li> <li>2. Reset the rotating motor</li> <li>3. The voltage of the power supply is too low.</li> <li>4. The load is too heavy.</li> <li>5. The motor power is too small.</li> </ol>	<ol style="list-style-type: none"> <li>1. Increase the ACC time</li> <li>2. Avoid the restarting after stopping.</li> <li>3. Check the power of the supply line</li> <li>4. Select an VFD with bigger power.</li> <li>5. Select a proper motor.</li> </ol>
OL3	Electrical overload	The VFD will report overload pre-alarm according to the set value.	Check the load and the overload pre-alarm point.
OH1	Rectifier overheated	<ol style="list-style-type: none"> <li>1. Air duct jam or fan damage</li> <li>2. Ambient temperature is too high.</li> <li>3. The time of overload running is too long.</li> </ol>	<ol style="list-style-type: none"> <li>1. Refer to the overcurrent solution</li> <li>2. Redistribute dredge the wind channel or change the fan</li> <li>3. Low the ambient temperature</li> <li>4. Check and reconnect</li> <li>5. Change the power</li> <li>6. Change the power unit</li> <li>7. Change the main control panel</li> </ol>
OH2	Inverter module overheated		
EF	External fault	SI external fault input terminals action	Check the external device input
CE	Communication error	<ol style="list-style-type: none"> <li>1. The baud rate setting is incorrect.</li> <li>2. Fault occurs to the communication wiring.</li> <li>3. The communication address is wrong.</li> <li>4. There is strong interference to the communication.</li> </ol>	<ol style="list-style-type: none"> <li>1. Set proper baud rate</li> <li>2. Check the communication connection distribution</li> <li>3. Set proper communication address.</li> <li>4. Chang or replace the connection distribution or improve the anti-interference capability.</li> </ol>

EEP	EEPROM fault	1. Error of controlling the write and read of the parameters 2. Damage to EEPROM	1. Press STOP/RST to reset 2. Change the main control panel
PIDE	PID feedback fault	1. PID feedback offline 2. PID feedback source disappear	1. Check the PID feedback signal 2. Check the PID feedback source
END	Time reach of factory setting	The actual running time of the VFD is above the internal setting running time.	Ask for the supplier and adjust the setting running time.
LL	Electronic underload fault	The VFD will report the underload pre-alarm according to the set value.	Check the load and the underload pre-alarm point.

## Chapter 7 Communication protocol

### 7.1 Modbus protocol introduction

Modbus protocol is a software protocol and common language which is applied in the electrical controller. With this protocol, the controller can communicate with other devices via network (the channel of signal transmission or the physical layer, such as RS485). And with this industrial standard, the controlling devices of different manufacturers can be connected to an industrial network for the convenient of being monitored.

There are two transmission modes for Modbus protocol: ASCII mode and RTU (Remote Terminal Units) mode. On one Modbus network, all devices should select same transmission mode and their basic parameters, such as baud rate, digital bit, check bit, and stopping bit should have no difference.

Modbus network is a controlling network with single-master and multiple slaves, which means that there is only one device performs as the master and the others are the slaves on one Modbus network. The master means the device which has active talking right to sent message to Modbus network for the controlling and inquiring to other devices. The slave means the passive device which sends data message to the Modbus network only after receiving the controlling or inquiring message (command) form the master (response). After the master sends message, there is a period of time left for the controlled or inquired slaves to response, which ensure there is only one slave sends message to the master at a time for the avoidance of singles impact.

Generally, the user can set PC, PLC, IPC and HMI as the masters to realize central control. Setting certain device as the master is a promise other than setting by a bottom or a switch or the device has a special message format. For example, when the upper monitor is running, if the operator clicks sending command bottom, the upper monitor can send command message actively even it can not receive the message form other devices. In this case, the upper monitor is the master. And if the designer makes the VFD send the data only after receiving the command, then the VFD is the slave.

The master can communicate with any single slave or with all slaves. For the single-visiting command, the slave should feedback a response message; for the broadcasting message from the master, the slave does not need to feedback the response message.

### 7.2 Application mode for the VFD

The Modbus protocol of the VFD is RTU mode and the physical layer is 2-wire RS485.

#### 7.2.1 Two-wire RS485

The interface of 2-wire RS485 works on semiduplex and its data signal applies differential transmission which is called balance transmission, too. It uses twisted pairs, one of which is defined as A (+) and the other is defined as B (-). Generally, if the positive electrical level between sending drive A and B is among +2~+6V, it is logic“1”, if the electrical level is among -2V~6V; it is logic“0”.

485+ on the terminal board corresponds to A and 485- to B.

Communication baud rate means the binary bit number in one second. The unit is bit/s (bps). The higher the baud rate is, the quicker the transmission speed is and the weaker the anti-interference is. If the twisted pairs of 0.56mm (24AWG) is applied as the communication cables, the Max. Transmission distance is as below:

Baud rate	Max. transmission distance	Baud rate	Max. transmission distance	Baud rate	Max. transmission distance	Baud rate	Max. transmission distance
2400BPS	1800m	4800BPS	1200m	9600BPS	800m	19200BPS	600m

It is recommended to use shield cables and make the shield layer as the grounding wires during RS485 remote communication.

In the cases with less devices and shorter distance, it is recommended to use 120Ω terminal resistor as the performance will be weakened if the distance increase even though the network can perform well without load resistor.

### 7.2.1.1 Single application

Figure 7-1 is the site Modbus connection figure of single VFD and PC. Generally, the computer does not have RS485 interface, the RS232 or USB interface of the computer should be converted into RS485 by converter. Connect the A terminal of RS485 to the 485+ terminal of the VFD and B to the 485- terminal. It is recommended to use the shield twisted pairs. When applying RS232-RS485 converter, if the RS232 interface of the computer is connected to the RS232 interface of the converter, the wire length should be as short as possible within the length of 15m. It is recommended to connect the RS232-RS485 converter to the computer directly. If using USB-RS485 converter, the wire should be as short as possible, too.

Select a right interface to the upper monitor of the computer (select the interface of RS232-RS485 converter, such as COM1) after the wiring and set the basic parameters such as communication baud rate and digital check bit to the same as the VFD.

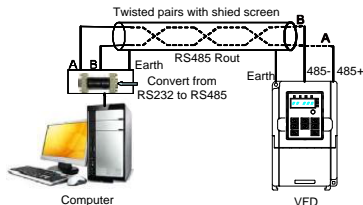

Figure 7-1 RS485 physical connection in single application

**7.2.1.2 Multi-application** In the real multi-application, the chrysanthemum connection and star connection are commonly used.

Chrysanthemum chain connection is required in the RS485 industrial fieldbus standards. The two ends are connected to terminal resistors of 120Ω which is shown in Figure 7-2.

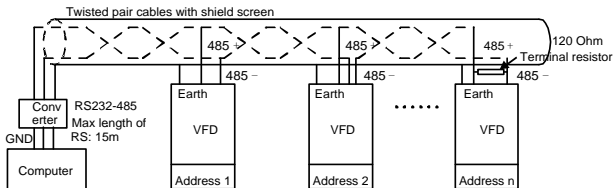

Figure 7-2 Chrysanthemum connection applications

Figure 7-3 is the star connection. Terminal resistor should be connected to the two devices which have the longest distance. (1# and 15#device)

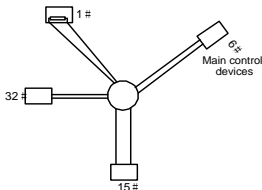

Figure 7-3 star connection

It is recommended to use shield cables in multiple connection. The basic parameter of the devices, such as baud rate and digital check bit in RS485 should be the same and there should be no repeated address.

## 7.2.2 RTU mode

### 7.2.2.1 RTU communication frame format

If the controller is set to communicate by RTU mode in Modbus network every 8bit byte in the message includes two 4Bit hex characters. Compared with ACSII mode, this mode can send more data at the same baud rate.

#### Code system

- 1 start bit
- 7 or 8 digital bit, the minimum valid bit can be sent firstly. Every 8 bit frame includes two hex characters (0...9, A...F)
- 1 even/odd check bit . If there is no checkout, the even/odd check bit is inexistent.
- 1 end bit (with checkout), 2 Bit(no checkout)

#### Error detection field

- CRC

The data format is illustrated as below:

11-bit character frame (BIT1 - BIT8 are the digital bits)

Start bit	BIT1	BIT2	BIT3	BIT4	BIT5	BIT6	BIT7	BIT8	Check bit	End bit
-----------	------	------	------	------	------	------	------	------	-----------	---------

10-bit character frame (BIT1 - BIT7 are the digital bits)



Start bit	BIT1	BIT2	BIT3	BIT4	BIT5	BIT6	BIT7	Check bit	End bit
-----------	------	------	------	------	------	------	------	-----------	---------

In a character frame, only the data bits carry information. The start bit, check bit, and end bit are used to facilitate the transmission of the data bits to the destination device. In practical applications, you must set the data bits, parity check bits, and end bits consistently.

In RTU mode, the transmission of a new frame always starts from an idle time (the transmission time of 3.5 bytes). On a network where the transmission rate is calculated based on the baud rate, the transmission time of 3.5 bytes can be easily obtained. After the idle time ends, the data domains are transmitted in the following sequence: slave address, operation command code, data, and CRC check character. Each byte transmitted in each domain includes 2 hexadecimal characters (0–9, A–F). The network devices always monitor the communication bus. After receiving the first domain (address information), each network device identifies the byte. After the last byte is transmitted, a similar transmission interval (the transmission time of 3.5 bytes) is used to indicate that the transmission of the frame ends. Then, the transmission of a new frame starts.

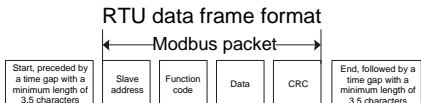

The information of a frame must be transmitted in a continuous data flow. If there is an interval greater than the transmission time of 1.5 bytes before the transmission of the entire frame is complete, the receiving device deletes the incomplete information, and mistakes the subsequent byte for the address domain of a new frame. Similarly, if the transmission interval between two frames is shorter than the transmission time of 3.5 bytes, the receiving device mistakes it for the data of the last frame. The CRC check value is incorrect due to the disorder of the frames, and thus a communication fault occurs.

The standard structure of RTU frame:

START	T1-T2-T3-T4(transmission time of 3.5 bytes)
ADDR	Communication address: 0 - 247(decimal system)(0 is the broadcast address)
CMD	03H:read slave parameters 06H:write slave parameters
DATA (N-1) ... DATA (0)	The data of 2*N bytes are the main content of the communication as well as the core of data exchanging
CRC CHK low bit	Detection value:CRC (16BIT)
CRC CHK high bit	
END	T1-T2-T3-T4(transmission time of 3.5 bytes)

### 7.2.2.2 RTU communication frame error checkout

Various factors (such as electromagnetic interference) may cause error in the data transmission. For example, if the sending message is a logic "1", A-B potential difference on RS485 should be 6V, but in reality, it may be -6V because of electromagnetic interference, and then the other devices take the sent message as logic "0". If there is no error checkout, the receiving devices will not find the message is wrong and they may give incorrect response which cause serious result. So the checkout is essential to the message.

The theme of checkout is that: the sender calculate the sending data according to a fixed formula, and then send the result with the message. When the receiver gets this message, they will calculate another result according to the same method and compare it with the sending one. If two results are the same, the message is correct. If not, the message is incorrect.

The error checkout of the frame can be divided into two parts: the bit checkout of the byte and the whole data checkout of the frame (CRC check).

#### Bit checkout of the byte

The user can select different bit checkouts or non-checkout, which impacts the check bit setting of each byte.

The definition of even checkout: add an even check bit before the data transmission to illustrate the number of "1" in the data transmission is odd number or even number. When it is even, the check byte is "0", otherwise, the check byte is "1". This method is used to stabilize the parity of the data.

The definition of odd checkout: add an odd check bit before the data transmission to illustrate the number of "1" in the data transmission is odd number or even number. When it is odd, the check byte is "0", otherwise, the check byte is "1". This method is used to stabilize the parity of the data.

For example, when transmitting "11001110", there are five "1" in the data. If the even checkout is applied, the even check bit is "1"; if the odd checkout is applied; the odd check bit is "0". The even and odd check bit is calculated on the check bit position of the frame. And the receiving devices also carry out even and odd checkout. If the parity of the receiving data is different from the setting value, there is an error in the communication.

#### CRC check

The checkout uses RTU frame format. The frame includes the frame error detection field which is based on the CRC calculation method. The CRC field is two bytes, including 16 figure binary values. It is added into the frame after calculated by transmitting device. The receiving device recalculates the CRC of the received frame and compares them with the value in the received CRC field. If the two CRC values are different, there is an error in the communication.

During CRC, 0xFFFF will be stored. And then, deal with the continuous 6-above bytes in the frame and the value in the register. Only the 8Bit data in every character is valid to CRC, while the start bit, the end and the odd and even check bit is invalid.

The calculation of CRC applies the international standard CRC checkout principles. When the user is editing CRC calculation, he can refer to the relative standard CRC calculation to write the required CRC calculation program.

Here provided a simple function of CRC calculation for the reference (programmed with C language):

```
unsigned int crc_cal_value(unsigned char *data_value, unsigned char data_length)
{
    int i;
```

```

unsigned int crc_value=0xffff;
while(data_length--)
{
  crc_value^=*data_value++;
  for(i=0;i<8;i++)
  {
    if(crc_value&0x0001)crc_value=(crc_value>>1)^0xa001;
    else crc_value=crc_value>>1;
  }
}
return(crc_value);
}

```

In ladder logic, CKSM calculated the CRC value according to the frame with the table inquiry. The method is advanced with easy program and quick calculation speed. But the ROM space the program occupied is huge. So use it with caution according to the program required space.

### 7.3 RTU command code and communication data description

#### 7.3.1 Command code: 03H

**03H(correspond to binary 0000 0011),read N words(Word)(the Max. continuous reading is 16 words)**

Command code 03H means that if the master read data form the VFD, the reading number depends on the "data number" in the command code. The Max. Continuous reading number is 16 and the parameter address should be continuous. The byte length of every data is 2 (one word). The following command format is illustrated by hex (a number with "H" means hex) and one hex occupies one byte.

The command code is used to read the working stage of the VFD.

For example, read continuous 2 data content from0004H from the VFD with the address of 01H (read the content of data address of 0004H and 0005H), the frame structure is as below:

RTU master command message (from the master to the VFD)

START	T1-T2-T3-T4 (transmission time of 3.5 bytes)
ADDR	01H
CMD	03H
High bit of the start bit	00H
Low bit of the start bit	04H
High bit of data number	00H
Low bit of data number	02H
CRC low bit	85H
CRC high bit	CAH
END	T1-T2-T3-T4 (transmission time of 3.5 bytes)

T1-T2-T3-T4 between START and END is to provide at least the time of 3.5 bytes as the leisure time and distinguish two messages for the avoidance of taking two messages as one message.

**ADDR** = 01H means the command message is sent to the VFD with the address of 01H and ADDR occupies one byte

**CMD**=03H means the command message is sent to read data form the VFD and CMD occupies one byte

**"Start address"** means reading data form the address and it occupies 2 bytes with the fact that the high bit

is in the front and the low bit is in the behind.

“**Data number**” means the reading data number with the unit of word. If the “start address’ is 0004H and the “data number” is 0002H, the data of 0004H and 0005H will be read.

**CRC** occupies 2 bytes with the fact that the high bit is in the front and the low bit is in the behind.

**RTU slave response message (from the VFD to the master)**

START	T1-T2-T3-T4 (transmission time of 3.5 bytes)
ADDR	01H
CMD	03H
Byte number	04H
Data high bit of address 0004H	13H
Data low bit of address 0004H	88H
Data high bit of address 0005H	00H
Data low bit of address 0005H	00H
CRC CHK low bit	7EH
CRC CHK high bit	9DH
END	T1-T2-T3-T4 (transmission time of 3.5 bytes)

The meaning of the response is that:

**ADDR = 01H** means the command message is sent to the VFD with the address of 01H and ADDR occupies one byte

**CMD=03H** means the message is received from the VFD to the master for the response of reading command and CMD occupies one byte

“**Byte number**” means all byte number from the byte(excluding the byte) to CRC byte(excluding the byte). 04 means there are 4 byte of data from the “byte number” to “CRC CHK low bit”, which are “digital address 0004H high bit”, “digital address 0004H low bit”, “digital address 0005H high bit” and “digital address 0005H low bit”.

There are 2 bytes stored in one data with the fact that the high bit is in the front and the low bit is in the behind of the message, the data of data address 0004H is 1388H, and the data of data address 0005H is 0000H.

**CRC** occupies 2 bytes with the fact that the high bit is in the front and the low bit is in the behind.

### 7.3.2 Command code: 06H

06H(correspond to binary 0000 0110), write one word(Word)

The command means that the master write data to the VFD and one command can write one data other than multiple dates. The effect is to change the working mode of the VFD.

For example, write 5000 (1388H) to 0004H from the VFD with the address of 02H, the frame structure is as below:

**RTU master command message (from the master to the VFD)**

START	T1-T2-T3-T4 (transmission time of 3.5 bytes)
ADDR	02H
CMD	06H
High bit of writing data address	00H

Low bit of writing data address	04H
data content	13H
data content	88H
CRC CHK low bit	C5H
CRC CHK high bit	6EH
END	T1-T2-T3-T4 (transmission time of 3.5 bytes)

RTU slave response message (from the VFD to the master)

START	T1-T2-T3-T4 (transmission time of 3.5 bytes)
ADDR	02H
CMD	06H
High bit of writing data address	00H
Low bit of writing data address	04H
High bit of data content	13H
Low bit of data content	88H
CRC CHK low bit	C5H
CRC CHK high bit	6EH
END	T1-T2-T3-T4 (transmission time of 3.5 bytes)

**Note:** section 7.31 and 7.32 mainly describe the command format, and the detailed application will be mentioned in 10.8 with examples.

### 7.3.3 Command code 08H for diagnosis

Meaning of sub-function codes

Sub-function Code	Description
0000	Return to inquire information data

For example: The inquiry information string is same as the response information string when the loop detection to address 01H of driver is carried out.

The RTU request command is:

START	T1-T2-T3-T4 (transmission time of 3.5 bytes)
ADDR	01H
CMD	08H
High byte of sub-function code	00H
Low byte of sub-function code	00H
High byte of data content	12H
Low byte of data content	ABH
Low byte of CRC	ADH
High byte of CRC	14H
END	T1-T2-T3-T4 (transmission time of 3.5 bytes)

The RTU response command is:

START	T1-T2-T3-T4 (transmission time of 3.5 bytes)
ADDR	01H
CMD	08H
High byte of sub-function code	00H
Low byte of sub-function code	00H
High byte of data content	12H
Low byte of data content	ABH
Low byte of CRC	ADH
High byte of CRC	14H
END	T1-T2-T3-T4 (transmission time of 3.5 bytes)

### 7.3.4 The definition of data address

The address definition of the communication data in this part is to control the running of the VFD and get the state information and relative function parameters of the VFD.

#### 7.3.4.1 The rules of parameter address of the function codes

The parameter address occupies 2 bytes with the fact that the high bit is in the front and the low bit is in the behind. The range of high and low byte are: high byte—00 - ffH; low byte—00 - ffH. The high byte is the group number before the radix point of the function code and the low byte is the number after the radix point. But both the high byte and the low byte should be changed into hex. For example P05.05, the group number before the radix point of the function code is 05, then the high bit of the parameter is 05, the number after the radix point 05, then the low bit of the parameter is 05, then the function code address is 0505H and the parameter address of P10.01 is 0A01H.

**Note:** P29 group is the factory parameter which can not be read or changed. Some parameters can not be changed when the VFD is in the running state and some parameters can not be changed in any state. Setting range, unit and relative instructions should be paid attention to when modifying the function code parameters.

Besides, EEPROM is stocked frequently, which may shorten the usage time of EEPROM. For users, some functions are not necessary to be stocked on the communication mode. The needs can be met on by changing the value in RAM. Changing the high bit of the function code from 0 to 1 can also realize the function. For example, the function code P00.07 is not stocked into EEPROM. Only by changing the value in RAM can set the address to 8007H. This address can only be used in writing RAM other than reading. If it is used to read, it is an invalid address.

#### 7.3.4.2 The address instruction of other function in Modbus

The master can operate on the parameters of the VFD as well as control the VFD, such as running or stopping and monitoring the working state of the VFD.

Below is the parameter list of other functions

Function instruction	Address definition	Data meaning instruction	R/W characteristics
Communication control command	2000H	0001H:forward running	R/W
		0002H:reverse running	
		0003H:forward jogging	
		0004H:reverse jogging	
		0005H:stop	
		0006H:coast to stop (emergency stop)	
		0007H:fault reset	
		0008H:jogging stop	
The address of the communication setting value	2001H	Communication setting frequency(0–Fmax(unit: 0.01Hz))	R/W
	2002H	PID reference, range(0 - 1000, 1000 corresponds to100.0% )	R/W
	2003H	PID feedback, range(0 - 1000, 1000 corresponds to100.0% )	R/W
	200AH	Virtual input terminal command , range: 0x000–0x1FF	R/W
	200BH	Virtual input terminal command , range: 0x00–0x0F	R/W
	200DH	AO output setting 1(-1000–1000, 1000 corresponds to 100.0%)	R/W
SW 1 of the VFD	2100H	0001H:forward running	R
		0002H:forward running	
		0003H:stop	
		0004H:fault	
		0005H: POF state	
SW 1 of the VFD	2101H	Bit0: =0:bus voltage is not established =1:bus voltage is established Bi1–2:=00:motor 1 Bit3: =0:asynchronous motor =1:synchronous motor Bit4:=0:pre-alarm without overload =1:overload pre-alarm Bit5 - Bit6:=00:keypad control =01:terminal control =10:communication control	R
Fault code of the VFD	2102H	See the fault type instruction	R
Identifying code of the VFD	2103H	Goodrive10----0x010d	R
Setting frequency	3001H	Compatible with GD series, CHF100A and CHV100	R
Bus voltage	3002H		R

Function instruction	Address definition	Data meaning instruction	R/W characteristics
Output voltage	3003H		R
Output current	3004H		R
Operation speed	3005H		R
Output power	3006H		R
Output torque	3007H		R
PID setting	3008H		R
PID feedback	3009H		R
Input IO state	300AH		R
Output IO state	300BH		R
AI 1	300CH		R
AI 2	300DH		R
Reserved	300EH		R
Reserved	300FH		R
Reserved	3010H		R
Reserved	3011H		R
Reserved	3012H		R
Reserved	3013H		R
External counting value	3014H		R
Torque setting	3015H		R
VFD code	3016H		R
Fault code	5000H	R	

R/W characteristics means the function is with read and write characteristics. For example, "communication control command" is writing characteristics and control the VFD with writing command (06H). R characteristic can only read other than write and W characteristic can only write other than read.

**Note:** When you operate on the VFD with the table above, it is necessary to enable some parameters. For example, the operation of running and stopping, it is necessary to set P00.01 to communication running command channel and set P00.02 to MODBUS communication channel. And when operate on "PID reference", it is necessary to set P09.00 to "MODBUS communication setting".

The encoding rules for device codes (corresponds to identifying code 2103H of the VFD)

Code high 8bit	Meaning	Code low 8 position	Meaning
01	GD	0x08	GD35 vector VFDs
		0x09	GD35-H1 vector VFDs
		0x0a	GD300 vector VFDs



Code high 8bit	Meaning	Code low 8 position	Meaning
		0x0b	GD100 simple vector VFDs
		0x0c	GD200 general VFDs
		0x0d	GD10 mini VFDs

**Note:** the code is consisted of 16 bit which is high 8 bits and low 8 bits. High 8 bits mean the motor type series and low 8 bits mean the derived motor types of the series. For example, 0110H means Goodrive10 vector VFDs.

### 7.3.5 Fieldbus ratio values

The communication data is expressed by hex in actual application and there is no radix point in hex. For example, 50.12Hz can not be expressed by hex so 50.12 can be magnified by 100 times into 5012, so hex 1394H can be used to express 50.12.

A non-integer can be timed by a multiple to get an integer and the integer can be called fieldbus ratio values. The fieldbus ratio values are referred to the radix point of the setting range or default value in the function parameter list. If there are figures behind the radix point ( $n=1$ ), then the fieldbus ratio value  $m$  is  $10^n$ . Take the table as the example:

Function code	Name	Details	Setting range	Default value	Modify
P01.20	Wake-up from sleep delay time	0.0 - 3600.0s (valid when P01.19=2)	0.0 - 3600.0	0.0s	<input type="radio"/>
P01.21	Restart after power off	0: Disable 1: Enable	0 - 1	0	<input type="radio"/>

If there is one figure behind the radix point in the setting range or the default value, then the fieldbus ratio value is 10. if the data received by the upper monitor is 50, then the "hibernation restore delay time" is 5.0 (5.0=50÷10).

If Modbus communication is used to control the hibernation restore delay time as 5.0s. Firstly, 5.0 can be magnified by 10 times to integer 50 (32H) and then this data can be sent.

**01**    **06**    **01 14**    **00 32**    **49 E7**  
 VFD    Write    Parameters    Data number    CRC check  
 address    command    address

After the VFD receives the command, it will change 50 into 5 according to the fieldbus ratio value and then set the hibernation restore delay time as 5s.

Another example, after the upper monitor sends the command of reading the parameter of hibernation restore delay time ,if the response message of the VFD is as following:

**01**    **03**    **02**    **00 32**    **39 91**  
 VFD    Read    2-byte    Parameter    CRC  
 address    command    data    data

Because the parameter data is 0032H (50) and 50 divided by 10 is 5, then the hibernation restore delay time is 5s.

### 7.3.6 Fault message response

There may be fault in the communication control. For example, some parameter can only be read. If a writing message is sent, the VFD will return a fault response message.

The fault message is from the VFD to the master, its code and meaning is as below:

Code	Name	Meaning
01H	Illegal command	The command from master can not be executed. The reason maybe: 1. This command is only for new version and this version can not realize. 2. Slave is in fault state and can not execute it.
02H	Illegal data address.	Some of the operation addresses are invalid or not allowed to access. Especially the combination of the register and the transmitting bytes are invalid.
03H	Illegal value	When there are invalid data in the message framed received by slave. <b>Note:</b> This error code does not indicate the data value to write exceed the range, but indicate the message frame is an illegal frame.
04H	Operation failed	The parameter setting in parameter writing is invalid. For example, the function input terminal can not be set repeatedly.
05H	Password error	The password written to the password check address is not same as the password set by P7.00.
06H	Data frame error	In the frame message sent by the upper monitor, the length of the digital frame is incorrect or the counting of CRC check bit in RTU is different from the lower monitor.
07H	Written not allowed.	It only happen in write command, the reason maybe: 1. The written data exceeds the parameter range. 2. The parameter should not be modified now. 3. The terminal has already been used.
08H	The parameter can not be changed during running	The modified parameter in the writing of the upper monitor can not be modified during running.
09H	Password protection	When the upper monitor is writing or reading and the user password is set without password unlocking, it will report that the system is locked.

The slave uses functional code fields and fault addresses to indicate it is a normal response or some error occurs (named as objection response). For normal responses, the slave shows corresponding function codes, digital address or sub-function codes as the response. For objection responses, the slave returns a code which equals the normal code, but the first byte is logic 1.

For example: when the master sends a message to the slave, requiring it to read a group of address data of the VFD function codes, there will be following function codes:

0 0 0 0 0 0 1 1 (Hex 03H)

For normal responses, the slave responds the same codes, while for objection responses, it will return:

1 0 0 0 0 0 1 1 (Hex 83H)

Besides the function codes modification for the objection fault, the slave will respond a byte of abnormal code which defines the error reason.

When the master receives the response for the objection, in a typical processing, it will send the message again or modify the corresponding order.

For example, set the "running command channel" of the VFD (P00.01, parameter address is 0001H) with the address of 01H to 03, the command is as following:

<b><u>01</u></b>	<b><u>06</u></b>	<b><u>00 01</u></b>	<b><u>00 03</u></b>	<b><u>98 0B</u></b>
VFD address	Write command	Parameter address	Parameter data	CRC

But the setting range of "running command channel" is 0 - 2, if it is set to 3, because the number is beyond the range, the VFD will return fault response message as below:

<b><u>01</u></b>	<b><u>86</u></b>	<b><u>04</u></b>	<b><u>43 A3</u></b>
VFD address	Exception response code	Error code	CRC

Abnormal response code 86H means the abnormal response to writing command 06H; the fault code is 04H. In the table above, its name is operation failed and its meaning is that the parameter setting in parameter writing is invalid. For example, the function input terminal can not be set repeatedly.

### 7.3.7 Example of writing and reading

Refer to 10.4.1 and 10.4.2 for the command format.

#### 7.3.7.1 Example of reading command 03H

Read the state word 1 of the VFD with the address of 01H (refer to table 1). From the table 1, the parameter address of the state word 1 of the VFD is 2100H.

The command sent to the VFD:

<b><u>01</u></b>	<b><u>03</u></b>	<b><u>21 00</u></b>	<b><u>00 01</u></b>	<b><u>8E 36</u></b>
VFD address	Read command	Parameter address	Data quantity	CRC

If the response message is as below:

<b><u>01</u></b>	<b><u>03</u></b>	<b><u>02</u></b>	<b><u>00 03</u></b>	<b><u>F8 45</u></b>
VFD address	Read command	Number of bytes	Data content	CRC

The data content is 0003H. From the table 1, the VFD stops.

Watch "the current fault type" to "the previous 5 times fault type" of the VFD through commands, the corresponding function code is P07.27 - P07.32 and corresponding parameter address is 071BH - 0720H(there are 6 from 071BH).

The command sent to the VFD:

<b><u>03</u></b>	<b><u>03</u></b>	<b><u>07 1B</u></b>	<b><u>00 06</u></b>	<b><u>B5 59</u></b>
VFD address	Read command	Start address	6 parameters in total	CRC

If the response message is as below:

**03 03 0C 00 23 00 23 00 23 00 23 00 23 00 23 00 23 5F D2**

VFD address    Read command    Number of bytes    Type of current fault    Type of last fault    Type of last but one fault    Type of last but two fault    Type of last but three fault    Type of last but four fault    CRC

See from the returned data, all fault types are 0023H (decimal 35) with the meaning of maladjustment (STO).

### 7.3.7.2 Example of writing command 06H

Make the VFD with the address of 03H to run forward. See table 1, the address of "communication control command" is 2000H and forward running is 0001. See the table below.

Function	Address	Data description	R/W
Communication-based control command	2000H	0001H: Forward running	R/W
		0002H: Reverse running	
		0003H: Forward jogging	
		0004H: Reverse jogging	
		0005H: Stop	
		0006H: Coast to stop (emergency stop)	
		0007H: Fault reset	
		0008H: Jogging to stop	

The command sent by the master:

**03**      **06**      **20 00**      **00 01**      **42 28**  
 VFD address    Write command    Parameter address    Forward running    CRC

If the operation is successful, the response may be as below (the same with the command sent by the master):

**03**      **06**      **20 00**      **00 01**      **42 28**  
 VFD address    Write command    Parameter address    Forward running    CRC

Set the Max. Output frequency of the VFD with the address of 03H as 100Hz.

Function code	Name	Detailed parameter description	Default value	Modify
P00.03	Max. output frequency	This parameter is used to set the maximum output frequency of the VFD. Users should pay attention to this parameter because it is the foundation of the frequency setting and the speed of acceleration and deceleration. Setting range: P00.04–400.00Hz	50.00Hz	☉

See the figures behind the radix point, the fieldbus ratio value of the Max. output frequency (P00.03) is 100. 100Hz timed by 100 is 10000 and the corresponding hex is 2710H.

The command sent by the master:

<b><u>03</u></b>	<b><u>06</u></b>	<b><u>00 03</u></b>	<b><u>27 10</u></b>	<b><u>62 14</u></b>
VFD address	Write command	Parameter address	Parameter data	CRC

If the operation is successful, the response may be as below (the same with the command sent by the master):

<b><u>03</u></b>	<b><u>06</u></b>	<b><u>00 03</u></b>	<b><u>27 10</u></b>	<b><u>62 14</u></b>
VFD address	Write command	Parameter address	Parameter data	CRC

**Note:** The blank in the above command is for illustration. The blank cannot be added in the actual application unless the upper monitor can automatically remove the blank.

## Appendix A Technical data

### A.1 Derating in application

#### A.1.1 Capacity

VFD sizing is based on the rated motor current and power. To achieve the rated motor power reference in the table, the rated current of the VFD must be higher than or equal to the rated motor current. Also the rated power of the VFD must be higher than or equal to the rated motor power. The power ratings are the same regardless of the supply voltage within one voltage range.

#### Note:

- The maximum allowed motor shaft power is limited to  $1.5 \cdot P_N$ . If the limit is exceeded, motor torque and current are automatically restricted. The function protects the input bridge of the drive against overload.
- The ratings apply at ambient temperature of  $40\text{ }^\circ\text{C}$
- It is important to check that in Common DC systems the power flowing through the common DC connection does not exceed  $P_N$ .

#### A.1.2 Derating

The load capacity decreases if the installation site ambient temperature exceeds  $40\text{ }^\circ\text{C}$ , the altitude exceeds 1000 meters or the carrier frequency is changed from 4 kHz to 8, 12 or 15 kHz.

##### A.1.2.1 Temperature-based derating

In the temperature range  $+40\text{ }^\circ\text{C}$  –  $+50\text{ }^\circ\text{C}$ , the rated output current is decreased by 1% for every additional  $1\text{ }^\circ\text{C}$ . Refer to the below list for the actual derating.

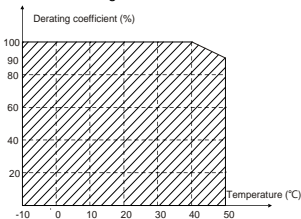

**Note:** It is not recommended to use the VFD at a temperature higher than  $50\text{ }^\circ\text{C}$ . If you do, you shall be held accountable for the consequences caused.

##### A.1.2.2 Altitude-based derating

When the altitude of the site where the VFD is installed is lower than 1000 m, the VFD can run at the rated power. If the altitude is higher than 1000 m, the allowable output power is derated. For details about the derating, see the following figure.

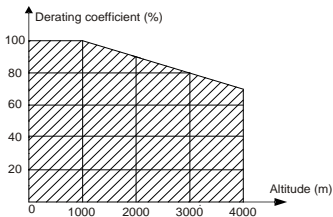

When the altitude exceeds 2000m, configure an isolation transformer on the input end of the VFD. When the altitude exceeds 3000m but is lower than 5000m, contact our company for technical consultation. Do not use the VFD at an altitude higher than 5000m.

### A.1.2.3 Carrier frequency-based derating

Setting range of carrier frequency in different power rating is different. The rated power is defined as its factory carrier frequency. The VFD has to derate 10% for every additional 1kHz carrier frequency if the carrier frequency exceeds the factory value.

## A.2 CE

### A.2.1 CE marking

The CE mark is attached to the drive to verify that the drive follows the provisions of the European Low Voltage (2006/95/EC) and EMC Directives (2004/108/EC).

### A.2.2 Compliance with the European EMC Directive

The EMC Directive defines the requirements for immunity and emissions of electrical equipment used within the European Union. The EMC product standard (EN 61800-3:2004) covers requirements stated for drives. See section *EMC regulations*

## A.3 EMC regulations

EMC product standard (EN 61800-3:2004) contains the EMC requirements to the VFD.

First environment: domestic environment (includes establishments connected to a low-voltage network which supplies buildings used for domestic purposes).

Second environment includes establishments connected to a network not directly supplying domestic premises.

Four categories of the VFD:

VFD of category C1: VFD of rated voltage less than 1000 V and used in the first environment.

VFD of category C2: VFD of rated voltage less than 1000 V other than pins, sockets and motion devices and intended to be installed and commissioned only by a professional electrician when used in the first environment.

**Note:** IEC/EN 61800-3 in EMC standard doesn't limit the power distribution of the VFD, but it defines the usage, installation and commission. The professional electrician has necessary skills in installing and/or commissioning power drive systems, including their EMC aspects.

VFD of category C3: VFD of rated voltage less than 1000 V and used in the second environment other than

the first one

VFD of category C4: VFD of rated voltage more than 1000 V or the nominal current is above or equal to 400A and used in the complicated system in second environment

### A.3.1 Category C2

The emission limits are complied with the following provisions:

1. The optional EMC filter is selected according to the options and installed as specified in the EMC filter manual.
2. The motor and control cables are selected as specified in this manual.
3. The drive is installed according to the instructions reference in this manual.



⚡ In a domestic environment, this product may cause radio interference, in which case supplementary mitigation measures may be required.

### A.3.2 Category C3

The immunity performance of the drive complies with the demands of IEC/EN 61800-3, second environment.

The emission limits are complied with the following provisions:

1. The optional EMC filter is selected according to the options and installed as specified in the EMC filter manual.
2. The motor and control cables are selected as specified in this manual.
3. The drive is installed according to the instructions reference in this manual.



⚠ A drive of category C3 is not intended to be used on a low-voltage public network which supplies domestic premises. Radio frequency interference is expected if the drive is used on such a network.



## Appendix B Dimension drawings

Dimension drawings of the Goodrive10 are shown below. The dimensions are given in millimeters and inches.

### B.1 Keypad structure

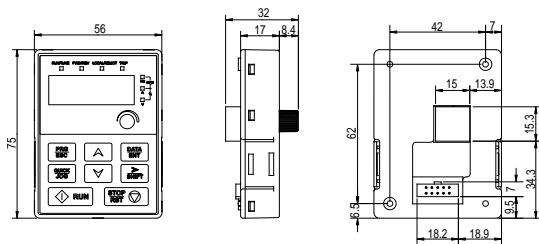

Figure B-1 Keypad structure diagram

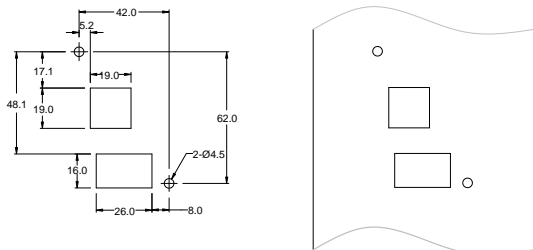
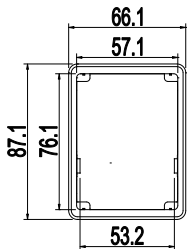
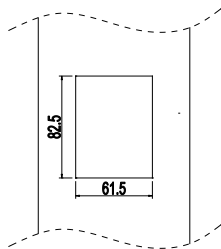

Figure B-2 Cut-out for keypad installation without brackets

The keypad can be externally installed on an optional bracket.



Installation bracket



Installation dimensions

## B.2 VFD chart

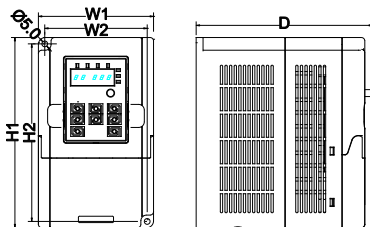

Wall mounting (unit: mm)

	Model	W1	W2	H1	H2	D
1PH 220V	GD10-0R2G-S2-B	85.0	74.0	145.5	131.5	134.2
	GD10-0R4G-S2-B	85.0	74.0	145.5	131.5	134.2
	GD10-0R7G-S2-B	85.0	74.0	145.5	131.5	153.2
	GD10-1R5G-S2-B	100.0	89.0	170.5	154.0	153.2
	GD10-2R2G-S2-B	100.0	89.0	170.5	154.0	153.2
3PH 220V	GD10-0R2G-2-B	85.0	74.0	145.5	131.5	134.2
	GD10-0R4G-2-B	85.0	74.0	145.5	131.5	134.2
	GD10-0R7G-2-B	85.0	74.0	145.5	131.5	153.2
	GD10-1R5G-2-B	100.0	89.0	170.5	154.0	153.2
	GD10-2R2G-2-B	100.0	89.0	170.5	154.0	153.2
3PH 380V	GD10-0R7G-4-B	100.0	89.0	170.5	154.0	153.2
	GD10-1R5G-4-B	100.0	89.0	170.5	154.0	153.2
	GD10-2R2G-4-B	100.0	89.0	170.5	154.0	153.2

## Appendix C Peripheral options and parts

This chapter describes how to select the options and parts of Goodrive10 series VFDs.

### C.1 Peripheral wiring

Figure C-1 shows the peripheral wiring of Goodrive10 series VFDs.

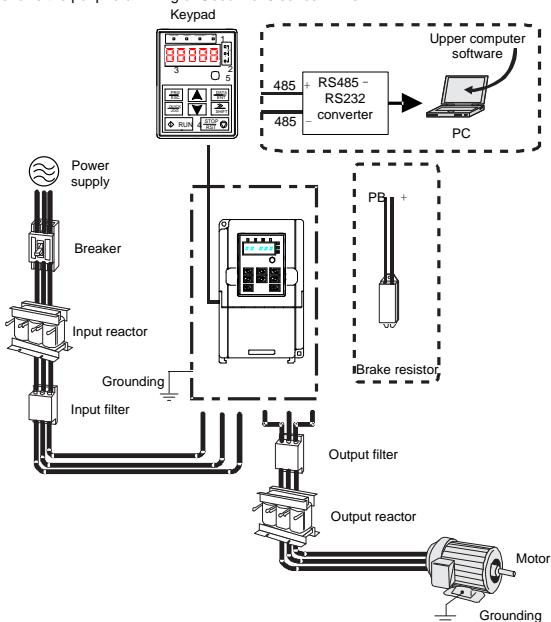









Figure C-1 Peripheral wiring of Goodrive10 series VFDs

Image	Name	Description
	Cables	Device to transfer the electronic signals
	Breaker	Prevent from electric shock and protect the power supply and the cables system from overcurrent when short circuits occur. (Please select the breaker with the function of reducing high order harmonic and the rated sensitive current to 1 VFD should be above 30mA).
	Input reactor	This device is used to improve the power factor of the input side of the VFD and control the higher harmonic current. The VFD above 37kW (including 37kW) can be connected with DC reactor.
	Input filter	Control the electromagnetic interference generated from the VFD, please install close to the input terminal side of the VFD.
	Braking resistors	Shorten the DEC time
	Output filter	Control the interference from the output side of the VFD and please install close to the output terminals of the VFD.
	Output reactor	Prolong the effective transmitting distance of the VFD to control the sudden high voltage when switching on/off the inverter unit of the VFD.

## C.2 Power supply

	◇ Check that the voltage degree of the VFD complies with the voltage of the supply power voltage.
--	---

## C.3 Cables

### C.3.1 Power cables

Dimension the input power and motor cables according to local regulations.

**Note:** A separate PE conductor is required if the conductivity of the cable shield is not sufficient for the purpose.

### C.3.2 Control cables

All analog control cables and the cable used for the frequency input must be shielded.

The relay cable needs the cable type with braided metallic screen.

**Note:** Run analog and digital signals in separate cables.

Check the insulation of the input power cable according to local regulations before connecting to the drive.

VFD	Recommended cable size(mm <sup>2</sup> )		Connecting cable size(mm <sup>2</sup> )				Terminal screw size	Tightening torque (Nm)
	RST UVW	PE	RST UVW	P1 and (+)	PB (+) and (-)	PE		
GD10-0R2G-S2-B	1.5	1.5	1.5	1.5	1.5	1.5	M3	0.56
GD10-0R4G-S2-B	1.5	1.5	1.5	1.5	1.5	1.5	M3	0.56
GD10-0R7G-S2-B	1.5	1.5	1.5	1.5	1.5	1.5	M3	0.56
GD10-1R5G-S2-B	2.5	2.5	2.5	2.5	2.5	2.5	M3	0.8
GD10-2R2G-S2-B	2.5	2.5	2.5	2.5	2.5	2.5	M3	0.8
GD10-0R2G-2-B	1.5	1.5	1.5	1.5	1.5	1.5	M3	0.56
GD10-0R4G-2-B	1.5	1.5	1.5	1.5	1.5	1.5	M3	0.56
GD10-0R7G-2-B	1.5	1.5	1.5	1.5	1.5	1.5	M3	0.56
GD10-1R5G-2-B	2.5	2.5	2.5	2.5	2.5	2.5	M3	0.8
GD10-2R2G-2-B	2.5	2.5	2.5	2.5	2.5	2.5	M3	0.8
GD10-0R7G-4-B	1.5	1.5	1.5	1.5	1.5	1.5	M3	0.8
GD10-1R5G-4-B	2.5	2.5	2.5	2.5	2.5	2.5	M3	0.8
GD10-2R2G-4-B	2.5	2.5	2.5	2.5	2.5	2.5	M3	0.8

**Note:**

- It is appropriate to use the recommended cable size under 40° C and rated current. The wiring distance should be no more than 100m.
- Terminals P1, (+), PB and (-) connects the DC reactor options and parts.

### C.4 Breaker and electromagnetic contactor

It is necessary to add fuse for the avoidance of overload.

It is appropriate to use a breaker (MCCB) which complies with the VFD power in the 3-phase AC power and input power and terminals. The capacity of the VFD should be 1.5-2 times of the rated current.

	<p>◇ Due to the inherent operating principle and construction of circuit breakers, independent of the manufacturer, hot ionized gases may escape from the breaker enclosure in case of a short-circuit. To ensure safe use, special attention must be paid to the installation and placement of the breakers. Follow the manufacturer's instructions.</p>
--	---

It is necessary to install the electromagnetic contactor in the input side to control the switching on and off safety of the main circuit. It can switch off the input power supply when system fault.

VFD	Fuse (A)	Breaker (A)	The rated working current of the contactor(A)
GD10-0R2G-S2-B	16	10	10
GD10-0R4G-S2-B	16	16	10
GD10-0R7G-S2-B	16	16	16
GD10-1R5G-S2-B	25	25	16
GD10-2R2G-S2-B	50	40	32
GD10-0R2G-2-B	6	6	6
GD10-0R4G-2-B	6	10	10
GD10-0R7G-2-B	10	10	10
GD10-1R5G-2-B	25	16	16
GD10-2R2G-2-B	32	25	16
GD10-0R7G-4-B	10	6	10
GD10-1R5G-4-B	10	10	10
GD10-2R2G-4-B	16	16	10

### C.5 Reactors

Transient high current in the input power circuit may cause damage to the rectifying components. It is appropriate to use AC reactor in the input side for the avoidance of high-voltage input of the power supply and improvement of the power factors.

When the distance between the VFD and motor is longer than 50 m, the parasitic capacitance between the long cable and ground may cause large leakage current, and overcurrent protection of the VFD may be frequently triggered. To prevent this from happening and avoid damage to the motor insulator, compensation must be made by adding an output reactor. When an VFD is used to drive multiple motors, take the total length of the motor cables (that is, sum of the lengths of the motor cables) into account. When the total length is longer than 50 m, an output reactor must be added on the output side of the VFD. If the distance between the VFD and motor is 50 m to 100 m, select the reactor according to the following table. If the distance is longer than 100 m, contact INVT's technical support technicians.

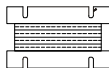
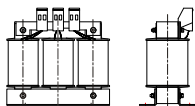

Input reactor

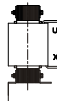
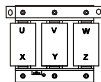

Output reactor

VFD	Input reactor	Output reactor
GD10-0R2G-S2-B	-	-
GD10-0R4G-S2-B	-	-
GD10-0R7G-S2-B	-	-
GD10-1R5G-S2-B	-	-
GD10-2R2G-S2-B	-	-
GD10-0R2G-2-B	ACL2-1R5-4	OCL2-1R5-4
GD10-0R4G-2-B	ACL2-1R5-4	OCL2-1R5-4
GD10-0R7G-2-B	ACL2-2R2-4	OCL2-2R2-4
GD10-1R5G-2-B		
GD10-2R2G-2-B		
GD10-0R7G-4-B	ACL2-1R5-4	OCL2-1R5-4
GD10-1R5G-4-B	ACL2-1R5-4	OCL2-1R5-4
GD10-2R2G-4-B	ACL2-2R2-4	OCL2-2R2-4

**Note:**

- The rated derate voltage of the input reactor is 2%±15%.
- The power factor of the input side is above 90% after adding DC reactor.
- The rated derate voltage of the output reactor is 1%±15%.
- Above options are external, the customer should indicate when purchasing.

**C.6 Filter**

The input interference filter can decrease the interference of the VFD to the surrounding equipments.

Output interference filter can decrease the radio noise cause by the cables between the VFD and the motor and the leakage current of the conducting wires.

Our company configured some filters for the convenient of the users.

**C.6.1 C3 Filter type instruction**

FLT - P 04 003 L - C - G  
A    B C    D E    F    G

Character designation	Detailed instruction
A	FLT:VFD filter series
B	Filter type P:power supply filter L:output filter
C	Voltage degree S2: AC 1PH 220V(-15%) - 240V(+10%) 04: AC 3PH 380V (-15%) - 440V(+10%)

Character designation	Detailed instruction
D	3-digit development serial number. For example, 003 stands for the serial number of C3 filters in development
E	Installation type L: Common type H: High performance type
F	Utilization environment of the filters A: the first environment (IEC61800-3:2004) category C1 (EN 61800-3:2004) B: the first environment (IEC61800-3:2004) category C2 (EN 61800-3:2004) C: the second environment (IEC61800-3:2004) category C3 (EN 61800-3:2004)
G	Lot No. G: Special for external C3 filter

### C.6.2 C3 filters

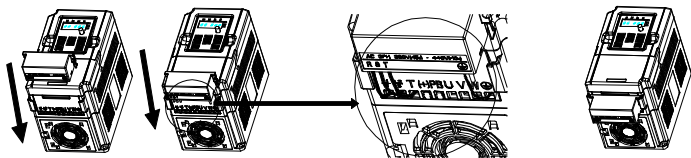

**Note:** When selecting C3 input filters, it is necessary to parallel-connect the filter to the VFD input.

The VFD	Input filter
GD10-0R2G-S2-B	FLT-PS2005L-C-G
GD10-0R4G-S2-B	FLT-PS2005L-C-G
GD10-0R7G-S2-B	FLT-PS2005L-C-G
GD10-1R5G-S2-B	FLT-PS2010L-C-G
GD10-2R2G-S2-B	FLT-PS2010L-C-G
GD10-0R2G-2-B	FLT-P04008L-C-G
GD10-0R4G-2-B	FLT-P04008L-C-G
GD10-0R7G-2-B	FLT-P04008L-C-G
GD10-1R5G-2-B	FLT-P04006L-C-G
GD10-2R2G-2-B	FLT-P04006L-C-G
GD10-0R7G-4-B	FLT-P04006L-C-G
GD10-1R5G-4-B	FLT-P04006L-C-G
GD10-2R2G-4-B	FLT-P04006L-C-G

**Note:**



- The input EMI meet the requirement of C3 after adding input filters.
- Above options are external, the customer should indicate when purchasing.

### C.6.3 C2 Filter type instruction

FLT - P 04 016 L - B  
A
B
C
D
E
F

Character designation	Detailed instruction
A	FLT:VFD filter series
B	Filter type P:power supply filter L:output filter
C	Voltage degree S2: AC 1PH 220V(-15%) - 240V(+10%) 04: AC 3PH 380V (-15%) - 440V(+10%)
D	3 bit rated current code "016" means 16A
E	Installation type L: Common type H: High performance type
F	Utilization environment of the filters A:the first environent (IEC61800-3:2004) category C1 (EN 61800-3:2004) B:the first environent (IEC61800-3:2004) category C2 (EN 61800-3:2004)

### C.6.4 C2 filters

VFD	Input filter	Output filter
GD10-0R2G-S2-B	FLT-PS2010H-A	FLT-L02010H-A
GD10-0R4G-S2-B	FLT-PS2010H-A	FLT-L02010H-A
GD10-0R7G-S2-B	FLT-PS2010H-A	FLT-L02010H-A
GD10-1R5G-S2-B	FLT-P04016L-B	FLT-L04016L-B
GD10-2R2G-S2-B	FLT-P04032L-B	FLT-L04032L-B
GD10-0R2G-2-B	FLT-P04006L-B	FLT-L04006L-B
GD10-0R4G-2-B	FLT-P04006L-B	FLT-L04006L-B
GD10-0R7G-2-B	FLT-P04006L-B	FLT-L04006L-B
GD10-1R5G-2-B	FLT-P04016L-B	FLT-L04016L-B
GD10-2R2G-2-B	FLT-P04016L-B	FLT-L04016L-B
GD10-0R7G-4-B	FLT-P04006L-B	FLT-L04006L-B

VFD	Input filter	Output filter
GD10-1R5G-4-B	FLT-P04006L-B	FLT-L04006L-B
GD10-2R2G-4-B	FLT-P04016L-B	FLT-L04016L-B

**Note:**



- The input EMI meet the requirement of C2 after adding input filters.
- Above options are external, the customer should indicate when purchasing.

**C.7 Braking system****C.7.1 Brake units**

The GD10 series products do not provide brake units. If a brake unit is required, you can select one according to the lot number.

**C.7.2 Select the brake components**

The motor will become a generator if its actual rotating speed is higher than the corresponding speed of the reference frequency. As a result, the inertial energy of the motor and load return to the inverter bridge to charge the capacitors in the main DC circuit. When the voltage increases to the limit, damage may occur to the VFD. It is necessary to apply braking resistor to avoid this accident happens.

	<ul style="list-style-type: none"> <li>◇ Only qualified electricians are allowed to design, install, commission and operate on the VFD.</li> <li>◇ Follow the instructions in "warning" during working. Physical injury or death or serious property may occur.</li> <li>◇ Only qualified electricians are allowed to wire. Damage to the VFD or braking options and part may occur. Read carefully the instructions of braking resistors or units before connecting them with the VFD.</li> <li>◇ Do not connect the braking resistor with other terminals except for PB and (-). Damage to the VFD or braking circuit or fire may occur.</li> </ul>
	<ul style="list-style-type: none"> <li>◇ Connect the braking device with the VFD according to the diagram. Incorrect wiring may cause damage to the VFD or other devices.</li> </ul>



Model	Braking resistor at 100% of the brakign torque(Ω)	Dissipation power (kW)	Dissipation power (kW)	Dissipation power (kW)	Mini braking resistor (Ω)
		10% braking	50% braking	80% braking	
GD10-0R2G-S2-B	722	0.03	0.15	0.24	42
GD10-0R4G-S2-B	361	0.06	0.30	0.48	42
GD10-0R7G-S2-B	192	0.11	0.56	0.90	42
GD10-1R5G-S2-B	96	0.23	1.1	1.8	30
GD10-2R2G-S2-B	65	0.33	1.7	2.6	21
GD10-0R2G-2-B	722	0.03	0.15	0.24	42

Model	Braking resistor at 100% of the brakign torque( $\Omega$ )	Dissipation power (kW)	Dissipation power (kW)	Dissipation power (kW)	Mini braking resistor ( $\Omega$ )
		10% braking	50% braking	80% braking	
GD10-0R4G-2-B	361	0.06	0.30	0.48	42
GD10-0R7G-2-B	192	0.11	0.56	0.90	42
GD10-1R5G-2-B	96	0.23	1.1	1.8	30
GD10-2R2G-2-B	65	0.33	1.7	2.6	21
GD10-0R7G-4-B	653	0.11	0.6	0.9	100
GD10-1R5G-4-B	326	0.23	1.1	1.8	100
GD10-2R2G-4-B	222	0.33	1.7	2.6	54

**Note:**

Select the resistor and power of the braking resistor according to the data our company provided.

The braking resistor may increase the braking torque of the VFD. Above table is measured at 100% braking torque, 10%, 50% and 80% braking usage rate, the user can select braking system according to actual working.

	⚡ Never use a brake resistor with a resistance below the minimum value specified for the particular drive. The drive and the internal chopper are not able to handle the overcurrent caused by the low resistance.
	⚡ Increase the power of the braking resistor properly in the frequent braking situation (the frequency usage ratio is more than 10%).

**C.7.3 Place the brake resistor**

Install all resistors in a place where they will cool.

	⚡ The materials near the brake resistor must be non-flammable. The surface temperature of the resistor is high. Air flowing from the resistor is of hundreds of degrees Celsius. Protect the resistor against contact.
--	--

Only external braking resistor is needed in Goodrive10.

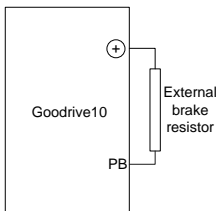

## Appendix D Further information

### D.1 Product and service inquiries

Should you have any queries about the product, contact the local INVT office. Provide the model and serial number of the product you query about. You can visit [www.invt.com](http://www.invt.com) to find a list of INVT offices.

### D.2 Feedback on INVT VFD manuals

Your comments on our manuals are welcome. Visit [www.invt.com](http://www.invt.com), directly contact online service personnel or choose **Contact Us** to obtain contact information.

### D.3 Online document library

You can find manuals and other product documents in the PDF format on the Internet. Visit [www.invt.com](http://www.invt.com) and choose **Service and Support > Data Download**.

 021-88406044  
09106611367  
WWW.LSKALA.COM



Service line:86-755-86312859

Website:www.invt.com

The products are owned by **Shenzhen INVT Electric Co.,Ltd.**

Two companies are commissioned to manufacture: (For product code, refer to the 2nd/3rd place of S/N on the name plate.)

**Shenzhen INVT Electric Co., Ltd.** (origin code: 01)

Address: INVT Guangming Technology Building, Songbai Road,  
Matian, Guangming District, Shenzhen, China

**INVT Power Electronics (Suzhou) Co., Ltd.** (origin code: 06)

Address: 1# Kunlun Mountain Road, Science&Technology Town,  
Gaixin District, Suzhou, Jiangsu, China

**Industrial Automation:** ■ VFD    ■ Servo & Motion Control    ■ Motor & Electric Spindle    ■ PLC

■ HMI    ■ Intelligent Elevator Control System    ■ Traction Drive

**Electric Power:**    ■ SVG    ■ Solar Inverter    ■ UPS    ■ Online Energy Management System



66001-00099

Copyright© INVT.

Manual information may be subject to change without prior notice.

201908 (V2.5)