



Operation **Manual**

Goodrive200A Series VFD



 021-88406044
09106611367
WWW.LSKALA.COM

SHENZHEN INVT ELECTRIC CO., LTD.

Preface

Thanks for choosing our products.

Goodrive200A series variable-frequency drive (VFD) is newly-designed vector-type VFD by our company for controlling asynchronous AC inductance motors. Through adopting the most advanced speed sensor-less vector control technology and DSP control system, as well as enhancing the reliability and adaptability to the environment, our product is armed with optimized functions, flexible applications and stable performances.

The vector control performance of Goodrive200A series VFD is as outstanding as that of the leading sophisticated VFDs in worldwide market. Its integrated speed and torque control can satisfy various application demands, in the meantime, its excellent anti-trip performance and strong adaptability to worse grid, temperature, humidity and dust guarantees its outstanding reliability and stability.

Goodrive200A series VFD adopts modular to fulfill various customized needs. The powerful speed control, torque control, simple PLC, flexible input/output terminals, pulse frequency reference and traverse control can satisfy various requirements from complicated drives to reduce system cost and improve system reliability.

Goodrive200A series VFD adopts electromagnetic compatibility design to ensure strong anti-electromagnetic interference capacity while realizing low noise and weakening electromagnetic interference in the application sites.

This manual presents installation and configuration, parameters setup, fault diagnoses and daily maintenance and relative precautions to customers. Please read this manual carefully before installation to ensure Goodrive200A series VFD is installed and operated properly to give full play to its excellent performance.

If the end user is a military unit or the product is used for weapon manufacturing, please comply with the relevant export control regulations of the ***Foreign Trade Law of the People's Republic of China*** and complete the necessary formalities.

Our company reserves the right to update the information of our products without prior notice.

Contents

Preface	i
Contents	ii
1 Safety precautions	1
1.1 What this chapter contains	1
1.2 Safety definition	1
1.3 Warning symbols	1
1.4 Safety guidelines	2
1.4.1 Delivery and installation	2
1.4.2 Commission and running	3
1.4.3 Maintenance and replacement of components	3
1.4.4 Scrap treatment	4
2 Quick start	5
2.1 What this chapter contains	5
2.2 Unpacking inspection	5
2.3 Application confirmation	5
2.4 Installation environment	5
2.5 Installation confirmation	6
2.6 Basic commissioning	6
3 Product overview	7
3.1 What this chapter contains	7
3.2 Basic principles	7
3.3 Product specifications	8
3.4 Nameplate	10
3.5 Type designation key	10
3.6 Rated specifications	10
3.7 Structure diagram	12
4 Installation guidelines	13
4.1 What this chapter contains	13
4.2 Mechanical installation	13
4.2.1 Installation environment	13
4.2.2 Installation direction	14
4.2.3 Installation manner	15
4.2.4 Multiple installations	16
4.2.5 Vertical installation	16
4.2.6 Tilt installation	17
4.3 Standard wiring	17
4.3.1 Wiring diagram of main circuit	17
4.3.2 Terminals figure of main circuit	19

4.3.3 Wiring of terminals in main circuit	22
4.3.4 Wiring diagram of control circuit.....	23
4.3.5 Terminals of control circuit	24
4.3.6 Input /Output signal connection figure.....	26
4.4 Layout protection	27
4.4.1 Protecting the VFD and input power cable in short-circuit situations.....	27
4.4.2 Protecting the motor and motor cable in short-circuit situations.....	27
4.4.3 Protecting the motor against thermal overload.....	28
4.4.4 Implementing a bypass connection.....	28
5 Keypad operation procedure.....	29
5.1 What this chapter contains	29
5.2 Keypad	29
5.3 Keypad displaying.....	31
5.4 Keypad operation.....	32
5.4.1 How to modify the function codes of the VFD.....	32
5.4.2 How to set the password of the VFD.....	32
5.4.3 How to watch the VFD state through function codes	33
6 Function parameters.....	34
6.1 What this chapter contains	34
6.2 Goodrive200A general series function parameters.....	34
P00 Group Basic functions.....	35
P01 Group Start and stop control	42
P02 Group Motor 1	48
P03 Group Vector control.....	50
P04 Group SVPWM control.....	54
P05 Group Input terminals	58
P06 Group Output terminals.....	66
P07 Group Human-Machine Interface	70
P08 Group Enhanced function	76
P09 Group PID control.....	84
P10 Group Simple PLC and multi-step speed control	88
P11 Group Protective parameters	91
P13 Group Enhanced function parameters.....	95
P14 Group Serial communication	95
P17 Group Monitoring function.....	98
P24 Group Water supply.....	100
7 Basic operation instruction	103
7.1 What this chapter contains	103
7.2 First powering on	103
7.3 Vector control.....	105

7.4 Torque control	106
7.5 Parameters of the motor	107
7.6 Start and stop control	108
7.7 Frequency setting	109
7.8 Simple PLC	111
7.9 Multi-step speed running	111
7.10 PID control	112
7.10.1 General steps of PID parameters setting:	113
7.10.2 PID inching	113
7.11 Pulse counter	115
8 Fault tracking	116
8.1 What this chapter contains	116
8.2 Alarm and fault indications	116
8.3 How to reset	116
8.4 Fault history	116
8.5 Fault instruction and solution	116
8.5.1 Other states	120
8.6 Common fault analysis	121
8.6.1 The motor does not work	121
8.6.2 Motor vibration	122
8.6.3 Overvoltage	122
8.6.4 Undervoltage fault	123
8.6.5 Abnormal motor heat	124
8.6.6 VFD overheating	124
8.6.7 Stall during the acceleration of the motor	125
8.6.8 Overcurrent	126
8.7 VFD system interference troubleshooting	126
8.8 Maintenance and hardware diagnostics	127
8.8.1 Overcurrent	127
8.8.2 Cooling fan	129
8.8.3 Capacitors	130
8.8.4 Power cable	131
9 Communication protocol	132
9.1 What this chapter contains	132
9.2 Brief instruction to MODBUS protocol	132
9.3 Application of the VFD	133
9.3.1 RS485	133
9.3.2 RTU mode	133
9.4 RTU command code and communication data illustration	136
9.4.1 RTU mode	136

9.4.2 ASCII mode.....	141
9.5 The definition of data address	143
9.5.1 The rules of parameter address of the function codes.....	144
9.5.2 The address instruction of other function in MODBUS	144
9.5.3 Fieldbus ratio values	147
9.5.4 Fault message response	148
9.6 Example of writing and reading	150
9.6.1 Example of reading command 03H.....	150
9.6.2 Example of writing command 06H	151
9.6.3 Example of continuous writing command 10H.....	153
Appendix A Technical data	155
A.1 What this chapter contains.....	155
A.2 Ratings.....	155
A.2.1 Capacity	155
A.2.2 Derating.....	155
A.3 Electric power network specification.....	156
A.4 Motor connection data	156
A.4.1 EMC compatibility and motor cable length.....	156
A.5 Applicable standards.....	157
A.5.1 CE marking.....	157
A.5.2 Compliance with the European EMC Directive	157
A.6 EMC regulations	157
A.6.1 Category C2	158
A.6.2 Category C3	158
Appendix B Dimension drawings.....	159
B.1 What this chapter contains.....	159
B.2 Keypad structure	159
B.2.1 Structure chart	159
B.2.2 Installation chart.....	159
B.3 VFD chart.....	160
B.3.1 Wall mounting	160
B.3.2 Flange mounting.....	163
B.3.3 Floor mounting.....	165
Appendix C Peripheral options and parts.....	166
C.1 What this chapter contains.....	166
C.2 Peripheral wiring.....	166
C.3 Power supply.....	167
C.4 Cables.....	167
C.4.1 Power cables.....	167
C.4.2 Control cables	168

C.4.3 Routing the cables	170
C.4.4 Checking the insulation	171
C.5 Breaker, electromagnetic contactor and leakage protection switch	171
C.6 Reactors	173
C.7 Filters	174
C.8 Braking system	176
C.8.1 Select the braking components	176
C.8.2 Select the brake resistor cables	178
C.8.3 Place the brake resistor	178
C.9 Other optional parts	179
Appendix D Further Information	180
D.1 Product and service inquiries	180
D.2 Feedback on INVT VFD manuals	180
D.3 Document library on the internet	180

1 Safety precautions

1.1 What this chapter contains

Read this manual carefully and follow all safety precautions before moving, installing, operating and servicing the variable-frequency drive (VFD). If ignored, physical injury or death may occur, or damage may occur to the devices.









If any physical injury or death or damage to the devices occurs for ignoring to the safety precautions in the manual, our company will not be responsible for any damages and we are not legally bound in any manner.

1.2 Safety definition





- Danger:** Serious physical injury or even death may occur if not follow relevant requirements
- Warning:** Physical injury or damage to the devices may occur if not follow relevant requirements
- Note:** Physical hurt may occur if not follow relevant requirements
- Qualified electricians:** People working on the device should take part in professional electrical and safety training, receive the certification and be familiar with all steps and requirements of installing, commissioning, operating and maintaining the device to avoid any emergency.

1.3 Warning symbols

Warnings caution you about conditions which can result in serious injury or death and/or damage to the equipment, and advice on how to avoid the danger. Following warning symbols are used in this manual:

Symbols	Name	Instruction	Abbreviation
 Danger	Electrical Danger	Serious physical injury or even death may occur if not follow the relative requirements	
 Warning	General danger	Physical injury or damage to the devices may occur if not follow the relative requirements	
 Do not touch	Electrostatic discharge	Damage to the PCBA board may occur if not follow the relative requirements	
 Hot	Hot sides	Sides of the device may become hot. Do not touch.	
Note	Note	Physical hurt may occur if not follow the relative requirements	Note

1.4 Safety guidelines

	<ul style="list-style-type: none"> ● Only qualified electricians are allowed to operate on the VFD. ● Do not carry out any wiring and inspection or changing components when the power supply is applied. Ensure all input power supply is disconnected before wiring and checking and always wait for at least the time designated on the VFD or until the DC bus voltage is less than 36V. Below is the table of the waiting time: <table border="1" data-bbox="264 376 962 510"> <thead> <tr> <th>VFD model</th> <th>Minimum waiting time</th> </tr> </thead> <tbody> <tr> <td>380V 0R7G–110G/132P</td> <td>5 minutes</td> </tr> <tr> <td>380V 132G/160P–315G/355P</td> <td>15 minutes</td> </tr> <tr> <td>380V 355G/400P and higher</td> <td>25 minutes</td> </tr> </tbody> </table>	VFD model	Minimum waiting time	380V 0R7G–110G/132P	5 minutes	380V 132G/160P–315G/355P	15 minutes	380V 355G/400P and higher	25 minutes
VFD model	Minimum waiting time								
380V 0R7G–110G/132P	5 minutes								
380V 132G/160P–315G/355P	15 minutes								
380V 355G/400P and higher	25 minutes								
	<ul style="list-style-type: none"> ● Do not refit the VFD unauthorized; otherwise fire, electric shock or other injury may occur. 								
	<ul style="list-style-type: none"> ● The base of the heat sink may become hot during running. Do not touch to avoid hurt. 								
	<ul style="list-style-type: none"> ● The electrical parts and components inside the VFD are electrostatic. Take measurements to avoid electrostatic discharge during relevant operation. 								

1.4.1 Delivery and installation

	<ul style="list-style-type: none"> ● Please install the VFD on fire-retardant material and keep the VFD away from combustible materials. ● Connect the braking optional parts (braking resistors, braking units or feedback units) according to the wiring diagram. ● Do not operate on the VFD if there is any damage or components loss to the VFD. ● Do not touch the VFD with wet items or body, otherwise electric shock may occur.
---	--

Note:

- Select appropriate moving and installing tools to ensure a safe and normal running of the VFD and avoid physical injury or death. For physical safety, the erector should take some mechanical protective measures, such as wearing exposure shoes and working uniforms.
- Ensure to avoid physical shock or vibration during delivery and installation.
- Do not carry the VFD by its cover. The cover may fall off.
- Install away from children and other public places. Please use the VFD on appropriate condition (See chapter 4.2.1 Installation environment).

- Don't allow screws, cables and other conductive items to fall inside the VFD.
- The leakage current of the VFD may be above 3.5mA during operation. Ground with proper techniques and ensure the grounding resistor is less than 10Ω. The conductivity of PE grounding conductor is the same as that of the phase conductor (with the same cross sectional area). For the 030G/037P and higher models, the cross sectional area of the PE grounding conductor can be slightly less than the recommended area.
- R, S and T are the input terminals of the power supply, while U, V and W are the motor terminals. Please connect the input power cables and motor cables with proper techniques; otherwise the damage to the VFD may occur.

1.4.2 Commission and running

	<ul style="list-style-type: none"> ● Disconnect all power supplies applied to the VFD before the terminal wiring and wait for at least the designated time after disconnecting the power supply. ● High voltage is present inside the VFD during running. Do not carry out any operation except for the keypad setting. It must be noted that the control terminal of EV1000 inverter is ELV (Extra Low Voltage) circuit, which cannot be connected directly to the accessible terminals of other devices if no protective isolation measure is taken. For instance, RS485 terminal of the inverter can be connected to RS232 interface of the PC only after a converter with protective isolation is connected between them. ● The VFD may start up by itself when P01.21=1. Do not get close to the VFD and motor. ● The VFD cannot be used as "Emergency-stop device". ● The VFD cannot be used to break the motor suddenly. A mechanical braking device should be provided.
---	--

Note:

- Do not switch on or off the input power supply of the VFD frequently.
- For the VFD that has been stored for a long time, check and fix the capacitance and try to run it again before utilization (see 8.8 Maintenance and hardware diagnostics).
- Cover the front board before running, otherwise electric shock may occur.



1.4.3 Maintenance and replacement of components

	<ul style="list-style-type: none"> ● Only qualified electricians are allowed to perform the maintenance, inspection, and components replacement of the VFD. ● Disconnect all power supplies to the VFD before the terminal wiring. Wait for at least the time designated on the VFD after disconnection. ● Take measures to avoid screws, cables and other conductive materials to fall into the VFD during maintenance and component replacement.
---	---

Note:

- Please select proper torque to tighten screws.
- Keep the VFD, parts and components away from combustible materials during maintenance and component replacement.
- Do not carry out any insulation voltage-endurance test on the VFD and do not measure the control circuit of the VFD by megameter.
- Carry out a sound anti-electrostatic protection to the VFD and its internal components during maintenance and component replacement.

1.4.4 Scrap treatment

	<ul style="list-style-type: none"> ● There are heavy metals in the VFD. Deal with it as industrial waste.
	<ul style="list-style-type: none"> ● When the life cycle ends, the product should enter the recycling system. Dispose of it separately at an appropriate collection point instead of placing it in the normal waste stream.

2 Quick start

2.1 What this chapter contains

This chapter mainly describes the basic guidelines during the installation and commission procedures on the VFD, which you may follow to install and commission the VFD quickly.

2.2 Unpacking inspection

Check as followings after receiving products:

- | |
|--|
| 1. Check whether the packing box is damaged or dampened. If yes, contact local dealers or INVT offices. |
| 2. Check the model identifier on the exterior surface of the packing box is consistent with the purchased model. If no, contact local dealers or INVT offices. |
| 3. Check whether the interior surface of packing box is abnormal, for example, in wet condition, or whether the enclosure of the VFD is damaged or cracked. If yes, contact local dealers or INVT offices. |
| 4. Check whether the name plate of the VFD is consistent with the model identifier on the exterior surface of the packing box. If not, contact local dealers or INVT offices. |
| 5. Check whether the accessories (including user's manual and control keypad) inside the packing box are complete. If not, contact local dealers or INVT offices. |

2.3 Application confirmation

Check the machine before beginning to use the VFD:

- | |
|---|
| 1. Check the load type to verify that there is no overload of the VFD during work and check whether the VFD needs to modify the power degree. |
| 2. Check that the actual current of the motor is less than the rated current of the VFD. |
| 3. Check that the control accuracy of the load is the same of the VFD. |
| 4. Check that the incoming supply voltage is correspondent to the rated voltage of the VFD. |

2.4 Installation environment

Check as followings before the actual installation and usage:

- | |
|---|
| 1. Check that the ambient temperature of the VFD is below 40°C. If exceeds, derate 1% for every additional 1°C. Additionally, the VFD cannot be used if the ambient temperature is above 50°C.
Note: for the cabinet VFD, the ambient temperature means the air temperature inside the cabinet. |
| 2. Check that the ambient temperature of the VFD in actual usage is above -10°C. If not, add heating facilities.
Note: For the cabinet VFD, the ambient temperature means the air temperature inside the cabinet. |

- | |
|---|
| 3. Check whether the VFD installation site altitude is less than 1000 meters. If yes, the VFD can run at the rated power.
When the installation site altitude exceeds 1000m, derate 1% for every increase of 100m; when the installation site altitude exceeds 3000m, consult the local INVT dealer or office. |
| 4. Check that the humidity of the actual usage site is below 90% and condensation is not allowed. If not, add additional protection to the VFDs. |
| 5. Check that the actual usage site is away from direct sunlight and foreign objects cannot enter the VFD. If not, add additional protective measures. |
| 6. Check that there is no conductive dust or flammable gas in the actual usage site. If not, add additional protection to VFDs. |

2.5 Installation confirmation

Check as followings after the installation:

- | |
|---|
| 1. Check that the input and output cables meet the need of actual load. |
| 2. Check that the accessories of the VFD are correctly and properly installed. The installation cables should meet the needs of every component (including input reactors, input filters, output reactors, output filters, DC reactors, braking units and braking resistors). |
| 3. Check that the VFD is installed on non-flammable materials and the calorific accessories (reactors and braking resistors) are away from flammable materials. |
| 4. Check that all control cables and power cables are run separately and the layout complies with EMC requirement. |
| 5. Check that all grounding systems are properly grounded according to the VFD requirements. |
| 6. Check that the free space during installation is sufficient according to the instructions in user's manual. |
| 7. Check that the installation conforms to the instructions in user's manual. The drive must be installed in an upright position. |
| 8. Check that the external connection terminals are tightly fastened and the torque is appropriate. |
| 9. Check that there are no screws, cables and other conductive items left in the VFD. If not, get them out. |

2.6 Basic commissioning

Complete the basic commissioning as followings before actual utilization:

- | |
|---|
| 1. Select the motor type, set correct motor parameters and select control mode of the VFD according to the actual motor parameters. |
| 2. Autotune. If possible, de-coupled from the motor load to start dynamic autotune. Or if not, static autotune is available. |
| 3. Adjust the ACC/DEC time according to the actual running of the load. |
| 4. Commission the device via jogging and check that the rotation direction is as required. If not, change the rotation direction by changing the wiring of motor. |
| 5. Set all control parameters and then operate. |

3 Product overview

3.1 What this chapter contains

The chapter briefly describes the operation principle, product characteristics, layout, nameplate and type designation information.

3.2 Basic principles

Goodrive200A series VFDs are wall, flange and floor mountable devices for controlling asynchronous AC inductance motors.

The diagram below shows the main circuit diagram of the VFD. The rectifier converts three-phase AC voltage to DC voltage. The capacitor bank of the intermediate circuit stabilizes the DC voltage. The converter transforms the DC voltage back to AC voltage for the AC motor. The brake pipe connects the external braking resistor to the intermediate DC circuit to consume the feedback energy when the voltage in the circuit exceeds its maximum limit.

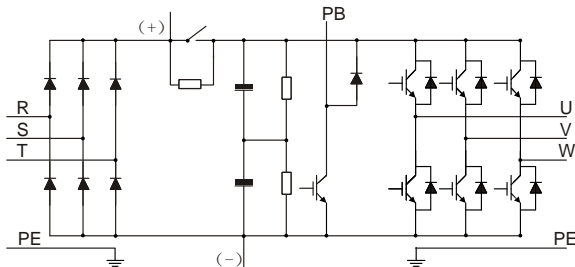

Figure 3-1 Main circuit diagram (for the 030G/037P and lower models)

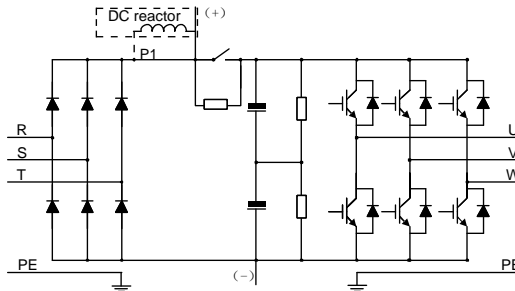

Figure 3-2 Main circuit diagram (for the 037G/045P and higher models)

Note:

1. The 037G/045P and higher models support external optional DC reactors. Before connecting, it is necessary to remove the copper strip between **P1** and **(+)**.

2. The 030G/037P and lower models have standard embedded braking units and the braking resistor is optional.

3. The 037G/045P and higher models can be installed with optional braking units and the braking unit and resistor are optional.

3.3 Product specifications

Function		Specification
Input	Input voltage (V)	AC 3PH 380V(-15%)–440V(+10%)
	Input current (A)	See Rated specifications.
	Input frequency (Hz)	50Hz or 60Hz Allowed range: 47–63Hz
Output	Output voltage (V)	0–Input voltage
	Output current (A)	See Rated specifications.
	Output power (kW)	See Rated specifications.
	Output frequency (Hz)	0–400Hz
Technical control feature	Control mode	SVPWM, SVC
	Motor type	Asynchronous motor
	Speed ratio	Asynchronous motor 1: 100 (sensorless vector control)
	Speed control accuracy	±0.2% (sensorless vector control)
	Speed fluctuation	± 0.3%(sensorless vector control)
	Torque response	<20ms(sensorless vector control)
	Torque control accuracy	10%(sensorless vector control)
	Starting torque	Asynchronous motor: 0.5Hz/150% (SVC)
Overload capability	G type: 150% of rated current: 1 minute 180% of rated current: 10 seconds 200% of rated current: 1 second P type: 120% of rated current: 1 minute 150% of rated current: 10 seconds 180% of rated current: 1 second	
Running control feature	Frequency setting	Digital setting, analog setting, pulse frequency setting, multi-step speed running setting, simple PLC setting, PID setting, MODBUS communication setting. Shift between the set combination and set channel.
	Auto voltage adjustment	Keep a stable voltage automatically when the grid voltage transients
	Fault protection	Provide over 30 fault protection functions: overcurrent, overvoltage, undervoltage, overheating, phase loss and overload, etc.

Function		Specification
	Speed tracking	Restart the rotating motor smoothly Note: This function is available for the 004G/5R5P and higher models.
Peripheral interface	Terminal analog input resolution	≤ 20mV
	Terminal switch input resolution	≤ 2ms
	Analog input	1 channels (AI2) 0 (2)–10V/0 (4)–20mA and 1 channel (AI3) -10–10V
	Analog output	2 channels (AO1, AO2) 0 (2)–10V /0 (4)–20mA
	Digital input	8 channels common input, max. frequency: 1kHz, internal impedance: 3.3kΩ; 1 channel high speed input, max. frequency: 50kHz
	Digital output	1 channel high speed pulse output, max. frequency: 50kHz; 1 channel Y terminal open collector pole output
	Relay output	2 channels programmable relay output RO1A NO, RO1B NC, RO1C common terminal RO2A NO, RO2B NC, RO2C common terminal Contactor capability: 3A/AC250V,1A/DC30V
Others	Mountable method	Wall, flange and floor mountable
	Temperature of the running environment	-10–50°C, derating is required if the temperature is above 40°C. If the ambient temperature is above 40°C, derate 1% for every additional 1°C.
	Ingress protection	IP20
	Cooling	Air-cooling
	Pollution level	Level 2
	Braking unit	Built in 030G/037P and lower models.For other models, it is an optional part.
	EMC filter	380V series products can meet the requirements of IEC61800-3 C3 External optional filter: meet the requirement of IEC61800-3 C2

3.4 Nameplate

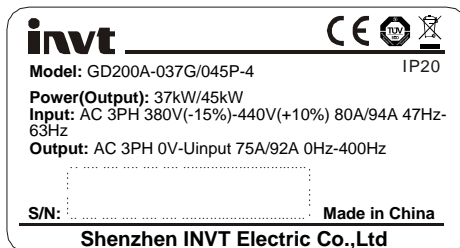

Figure 3-3 Nameplate

Note: This is the example of the nameplate for the standard products, and CE\TUV\IP20 will be marked according to the actual situations.

3.5 Type designation key

The type designation contains information on the VFD. The user can find the type designation on the type designation label attached to the VFD or the simple nameplate.

GD200A-011 G/015 P-4
 ① ② ③ ④ ⑤ ⑥

Figure 3-4 Product type

Key	Instructions
①	GD200A : abbreviation of Goodrive200A
②, ④	3-digit code: output power. "R" means the decimal point; "011": 11kW; "015": 15kW
③, ⑤	G: Constant torque load
	P: Variable torque load
⑥	Input voltage degree: 4: AC 3PH 380V(-15%)–440V(+10%)

3.6 Rated specifications

VFD model	Constant torque			Variable torque		
	Output power (kW)	Input current (A)	Output current (A)	Output power (kW)	Input current (A)	Output current (A)
GD200A-0R7G-4	0.75	3.4	2.5	/	/	/
GD200A-1R5G-4	1.5	5.0	3.7	/	/	/
GD200A-2R2G-4	2.2	5.8	5	/	/	/

VFD model	Constant torque			Variable torque		
	Output power (kW)	Input current (A)	Output current (A)	Output power (kW)	Input current (A)	Output current (A)
GD200A-004G/5R5P-4	4	13.5	9.5	5.5	19.5	14
GD200A-5R5G/7R5P-4	5.5	19.5	14	7.5	25	18.5
GD200A-7R5G/011P-4	7.5	25	18.5	11	32	25
GD200A-011G/015P-4	11	32	25	15	40	32
GD200A-015G/018P-4	15	40	32	18.5	47	38
GD200A-018G/022P-4	18.5	47	38	22	56	45
GD200A-022G/030P-4	22	56	45	30	70	60
GD200A-030G/037P-4	30	70	60	37	80	75
GD200A-037G/045P-4	37	80	75	45	94	92
GD200A-045G/055P-4	45	94	92	55	128	115
GD200A-055G/075P-4	55	128	115	75	160	150
GD200A-075G/090P-4	75	160	150	90	190	180
GD200A-090G/110P-4	90	190	180	110	225	215
GD200A-110G/132P-4	110	225	215	132	265	260
GD200A-132G/160P-4	132	265	260	160	310	305
GD200A-160G/185P-4	160	310	305	185	345	340
GD200A-185G/200P-4	185	345	340	200	385	380
GD200A-200G/220P-4	200	385	380	220	430	425
GD200A-220G/250P-4	220	430	425	250	485	480
GD200A-250G/280P-4	250	485	480	280	545	530
GD200A-280G/315P-4	280	545	530	315	610	600
GD200A-315G/355P-4	315	610	600	355	625	650
GD200A-355G/400P-4	355	625	650	400	715	720
GD200A-400G-4	400	715	720	/	/	/
GD200A-450G-4	450	840	820	/	/	/
GD200A-500G-4	500	890	860	/	/	/

Note:

1. The input current of the 0R7G–315G/355P models is measured when the input voltage is 380V and no DC reactor and input/output reactor.
2. The input current of the 355G/400P–500G models is measured when the input voltage is 380V and the circuit is with input reactor.
3. The rated output current is defined as the output current when the output voltage is 380V.
4. In the allowable voltage range, the output power and current cannot exceed the rated output power and current in any situation.

3.7 Structure diagram

Below is the VFD layout figure (taking the 030G/037P model for example).

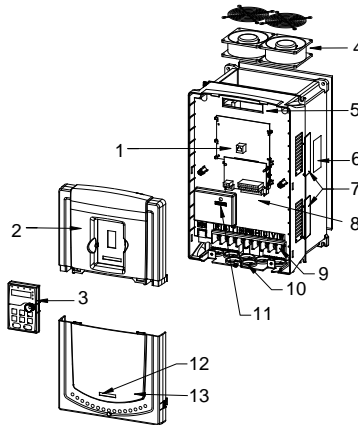



Figure 3-5 Product structure diagram

Serial No.	Name	Illustration
1	Keypad port	Connect the keypad
2	Upper cover	Protect the internal parts and components
3	Keypad	See 5.4 Keypad operation for detailed information
4	Cooling fan	See 8.8 Maintenance and hardware diagnostics for detailed information
5	Wires port	Connect to the control board and the drive board
6	Nameplate	See 3 Product overview for detailed information
7	Side cover	Optional part. The side cover will increase the protective degree of the VFD. The internal temperature of the VFD will increase, too, so it is necessary to derate the VFD at the same time
8	Control terminals	See 4 Installation guidelines for detailed information
9	Main circuit terminals	See 4 Installation guidelines for detailed information
10	Main circuit cable entry	Fix the main circuit cable
11	POWER light	Power indicator
12	Simple nameplate	See 3 Product overview for detailed information
13	Lower cover	Protect the internal parts and components

4 Installation guidelines

4.1 What this chapter contains

The chapter describes the mechanical installation and electric installation.

	<ul style="list-style-type: none"> ● Only qualified electricians are allowed to carry out what described in this chapter. Please operate as the instructions in chapter 1 Safety precautions. Ignoring these may cause physical injury or death or damage to the devices. ● Ensure the power supply of the VFD is disconnected during the operation. Wait for at least the time designated until the POWER indicator is off after the disconnection if the power supply is applied. It is recommended to use the multimeter to monitor that the DC bus voltage of the drive is under 36V. ● The installation and design of the VFD should be complied with the requirement of the local laws and regulations in the installation site. If the installation infringes the requirement, our company will exempt from any responsibility. Additionally, if users do not comply with the suggestion, some damage beyond the assured maintenance range may occur.
---	---

4.2 Mechanical installation

4.2.1 Installation environment

The installation environment is important for a full performance and long-term stable functions of the VFD. Check the installation environment as followings:

Environment	Conditions
Installation site	Indoor
Environment temperature	<p>-10—+50°C</p> <p>If the ambient temperature of the VFD is above 40°C, derate 1% for every additional 1°C.</p> <p>It is not recommended to use the VFD if the ambient temperature is above 50°C.</p> <p>In order to improve the reliability of the device, do not use the VFD if the ambient temperature changes frequently.</p> <p>Please provide cooling fan or air conditioner to control the internal ambient temperature below the required one if the VFD is used in a close space such as in the control cabinet.</p> <p>When the temperature is too low, if the VFD needs to restart to run after a long stop, it is necessary to provide an external heating device to increase the internal temperature, otherwise damage to the devices may occur.</p>
Humidity	<p>RH≤90%</p> <p>No condensation is allowed.</p> <p>The maximum relative humidity should be equal to or less than 60% in corrosive air.</p>

Environment	Conditions
Storage temperature	-30 to +60°C
Running environment condition	The installation site of the VFD should meet the following requirements. Away from the electromagnetic radiation source; Away from contaminative air, such as corrosive gas, oil mist and flammable gas; Ensure foreign objects, such as metal power, dust, oil, water cannot enter into the VFD (do not install the VFD on the flammable materials such as wood); Away from direct sunlight, oil mist, steam and vibration environment.
Altitude	Below 1000 meters When the installation site altitude exceeds 1000m, derate 1% for every increase of 100m; when the installation site altitude exceeds 3000m, consult the local INVT dealer or office.
Vibration	$\leq 5.8\text{m/s}^2(0.6\text{g})$
Installation direction	The VFD should be installed on an upright position to ensure sufficient cooling effect.

Note:

- Goodrive200A series VFDs should be installed in a clean and ventilated environment according to enclosure classification.
- Cooling air must be clean, free from corrosive materials and electrically conductive dust.

4.2.2 Installation direction

The VFD may be installed on the wall or in a cabinet.

The VFD must be installed in an upright position. Check the installation site according to the requirements below. For frame details, please see Appendix B Dimension drawings.

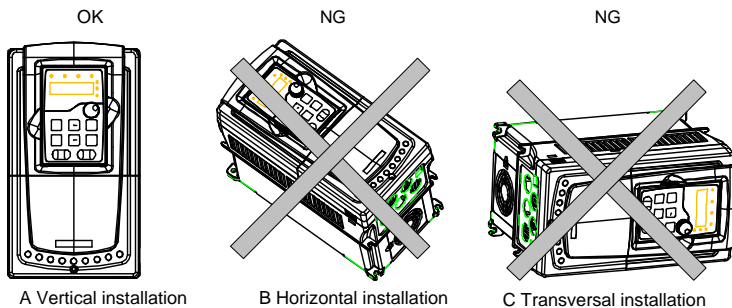

Figure 4-1 Installation direction of the VFD

4.2.3 Installation manner

The VFD can be installed in two different ways, depending on the frame size:

- a) Wall mounting (for the 315G/355P and lower models)
- b) Flange mounting (for the 200G/220P and lower models). Some need optional flange installation board.
- c) Floor mounting (for the 220G/250P–500G models). Some need optional base.

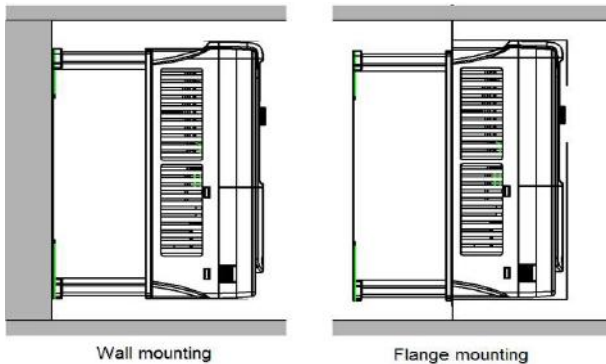

Figure 4-2 Installation manner

- (1) Mark the hole location. The location of the holes is shown in the dimension drawings in the appendix.
- (2) Fix the screws or bolts to the marked locations.
- (3) Position the drive onto the wall.
- (4) Tighten the screws in the wall securely.

Note:

- The flange installation bracket is needed in the flange installation of the 0R7G–030G/037P models while the flange installation of the 037G/045P–200G/220P models does not need the installation bracket.
- The 220G/250P–315G/355P models need optional base in the floor installation.

4.2.4 Multiple installations

Parallel installation

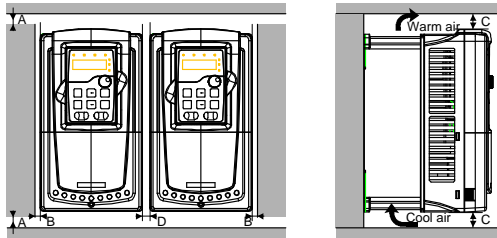

Figure 4-3 Parallel installation

Note:

- Before installing the different size VFDs, please align their top position for the convenience of later maintenance.
- The minimum space of B, D and C is 100mm.

4.2.5 Vertical installation

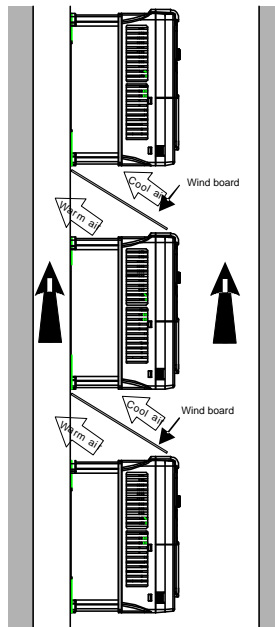

Figure 4-4 Vertical installation

Note: Windscreen should be added in vertical installation for avoiding mutual impact and insufficient cooling.

4.2.6 Tilt installation

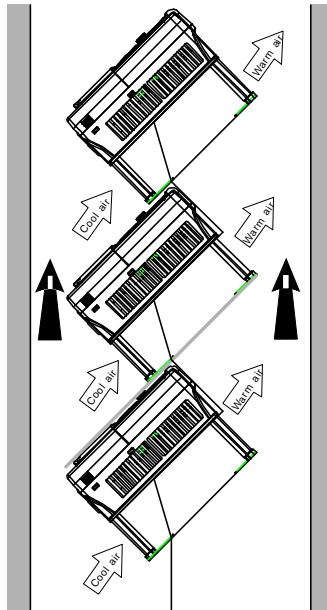

Figure 4-5 Tilt installation

Note: Ensure the separation of the wind input and output channels in tilt installation for avoiding mutual impact.

4.3 Standard wiring

4.3.1 Wiring diagram of main circuit

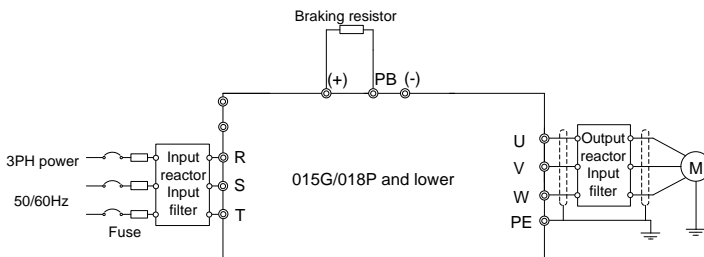

Figure 4-6 Main circuit wiring diagram for the 015G/018P and lower models

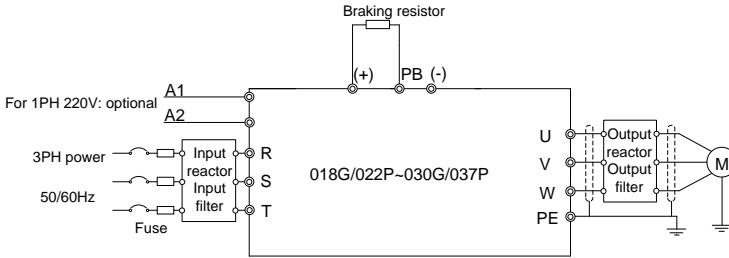

Figure 4-7 Main circuit wiring diagram for the 018G/022P-030G/037P models

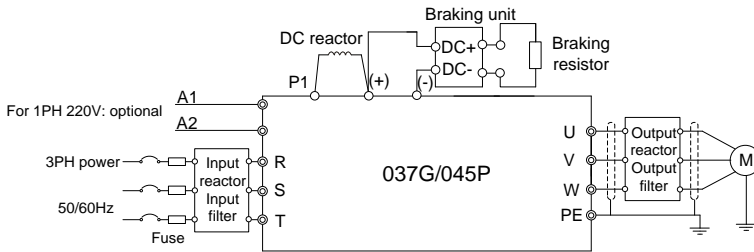

Figure 4-8 Main circuit wiring diagram for the 037G/045P and higher models

Note:

- The fuses, DC reactors, braking units, braking resistors, input reactors, input filters, output reactors and output filters are optional parts. Please refer to Peripheral options and parts for detailed information.
- **A1** and **A2** are optional parts for the 018G/022P and higher models.
- **P1** and **(+)** are short circuited in factory, if need to connect with the DC reactor, please remove the contact tag between **P1** and **(+)**.
- Before connecting the braking resistor cable, remove the yellow labels of **PB**, **(+)**, and **(-)** from the terminal blocks. Otherwise, poor connection may occur.

4.3.2 Terminals figure of main circuit

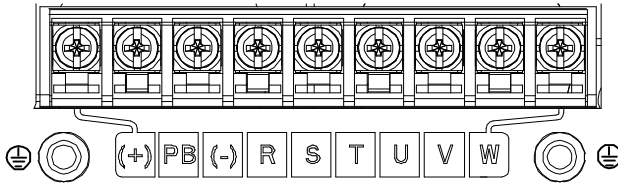

Figure 4-9 Main circuit terminals for the 0R7G-5R5G/7R5G models

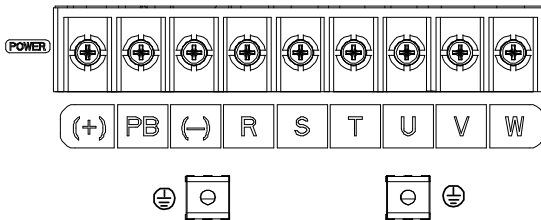

Figure 4-10 Main circuit terminals for the 7R5G/011P-015G/018P models

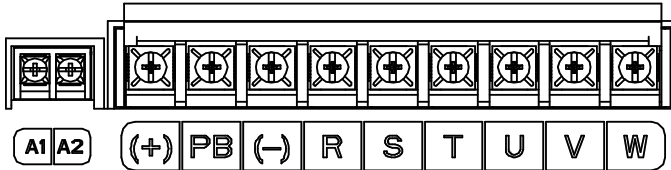

Figure 4-11 Main circuit terminals for the 018G/022P model

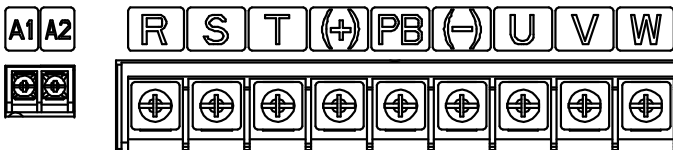

Figure 4-12 Main circuit terminals for the 022G/030P-030G/037P models

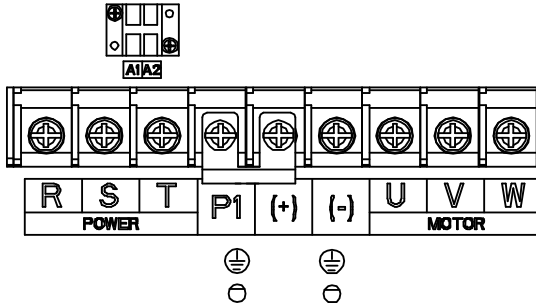

Figure 4-13 Main circuit terminals for the 037G/045P-055G/075P models

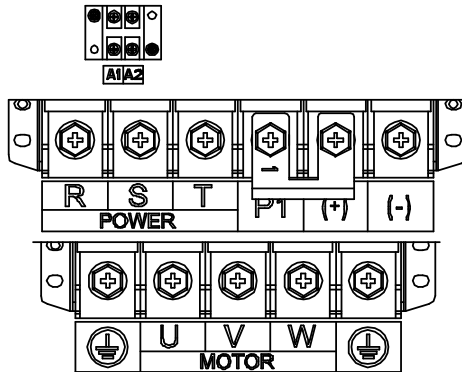

Figure 4-14 Main circuit terminals for the 075G/090P-110G/132P models

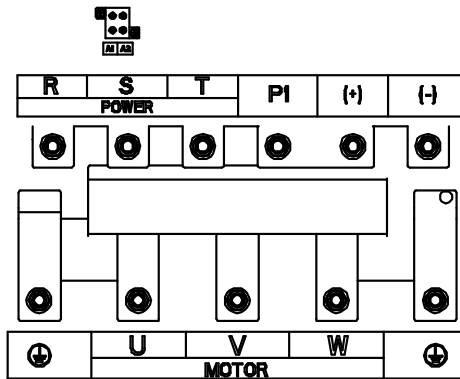

Figure 4-15 Main circuit terminals for the 132G/160P-200G/220P models

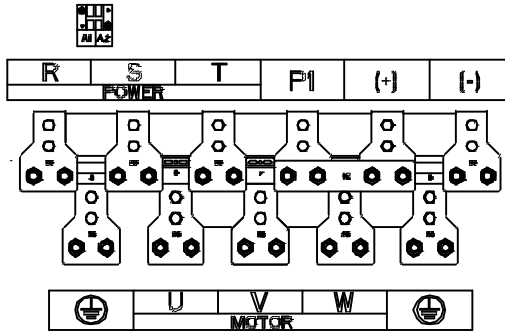

Figure 4-16 Main circuit terminals for the 220G/250P–315G/355P models

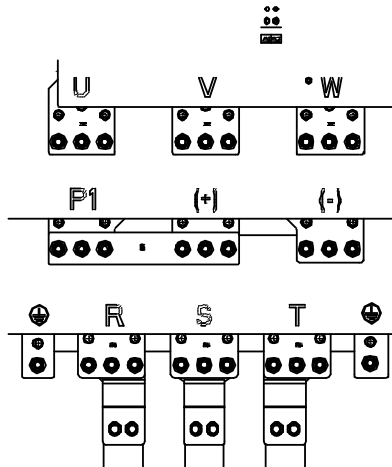

Figure 4-17 Main circuit terminals for the 355G/400P–500G models

Terminal	Terminal name		Function
	For the 030G/037P and lower models	For the 037G/045P and higher models	
R, S, T	Power input of the main circuit		3-phase AC input terminals which are generally connected with the power supply.
U, V, W	The VFD output		3-phase AC output terminals which are generally connected with the motor.

Terminal	Terminal name		Function
	For the 030G/037P and lower models	For the 037G/045P and higher models	
P1	This terminal is inexistent	DC reactor terminal 1	P1 and (+) are connected with the terminals of DC reactor. (+) and (-) are connected with the terminals of braking unit.
(+)	Braking resistor 1	DC reactor terminal 2, braking unit terminal 1	
(-)	/	Braking unit terminal 2	
PB	Braking resistor terminal 2	This terminal is inexistent.	PB and (+) are connected with the terminals of braking resistor.
PE	Protective grounding terminals		Every machine is provided 2 PE terminals as the standard configuration. These terminals should be grounded with proper techniques. 380V: the grounding resistor is less than 10 ohms
A1 and A2	Control power terminal		Optional for the 018G/022P and higher models (connect to external 220V control power). Power can be supplied via auxiliary power, making it more convenient for commissioning.

Note:

- Do not use an asymmetrically constructed motor cable. If there is a symmetrically constructed grounding conductor in the motor cable in addition to the conductive shield, connect the grounding conductor to the grounding terminal at the VFD and motor ends.
- Braking resistor, braking unit and DC reactor are optional parts.
- Route the motor cable, input power cable and control cables separately.
- GD series VFDs cannot share the DC bus with CH series VFDs.
- When sharing the DC bus, the VFDs must be the same in power and must be simultaneously powered on or off.
- In shared DC bus running mode, current balance on the VFD input side must be considered during wiring, and equalizing reactors are recommended to be configured.
- If the terminal is not appeared, the machine does not provide the terminal as the external terminal.

4.3.3 Wiring of terminals in main circuit

1. Connect the ground line of input power cable to the ground terminal (PE) of VFD directly, and connect 3PH input cable to R, S and T and fasten up.

2. Connect the ground line of motor cable to the ground terminal of the VFD, and connect the 3PH motor cable to U, V, W and fasten up.
3. Connect the brake resistor which carries cables to the designated position.
4. Fasten up all the cables on the outside of the VFD if allowed.

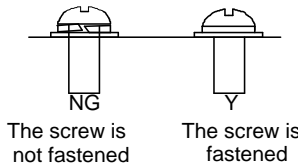

Figure 4-18 Correct installation of the screw

4.3.4 Wiring diagram of control circuit

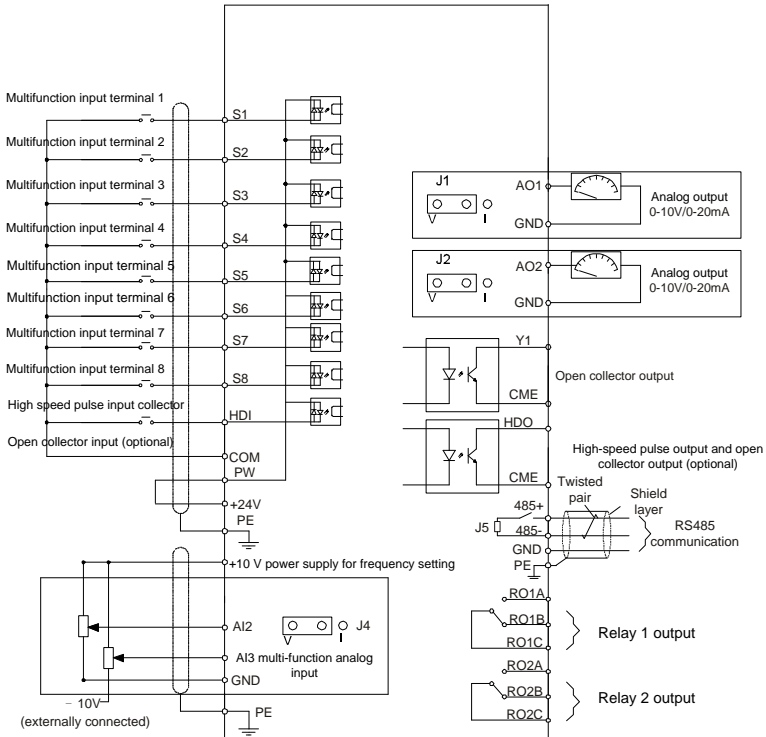

Figure 4-19 Wiring diagram of the control circuit

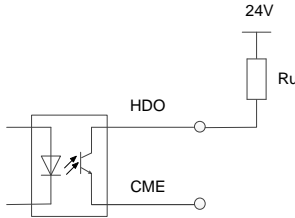

Figure 4-20 HDO wiring diagram

Note: HDO is an open collector and requires a resistor (Ru) when connecting to the 24V power. It is recommended to use a resistor with a rated power of 1W or 2W and a resistance of 700Ω~1000Ω.

4.3.5 Terminals of control circuit

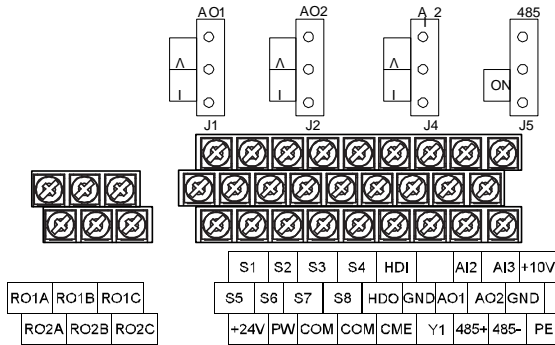

Figure 4-21 Control circuit terminals for the 015G/018P and lower models

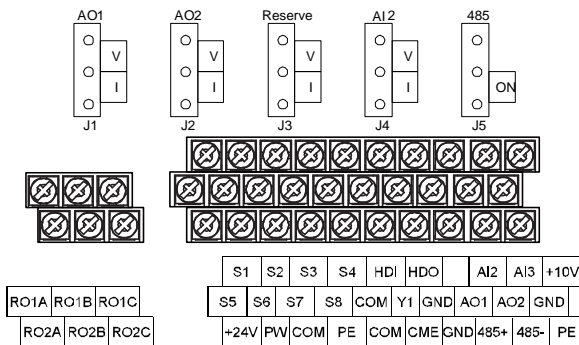

Figure 4-22 Control circuit terminals for the 018G/022P and higher models

Note: the spare terminal is reserved and not be used.

Terminal name	Description	
HDO	1. Switch output: 50mA/30V 2. Output frequency range: 0 - 50kHz	
COM	+24V common terminal	
CME	Common terminal of HDO and Y1, short-connected with COM in factory	
Y1	1.Swtich capability: 50mA/30V 2.Output frequency range: 0 - 1kHz	
485+	485 communication interface and 485 differential signal interface	
485-	If it is the standard 485 communication interface, please use twisted pairs or shield cable.	
+10V	Local power supply +10V	
AI2	1. Input range: AI2 voltage and current can be chose: 0 (2)-10V/0 (4)-20mA; AI2 can be shifted by J4; AI3: -10V-+10V	
AI3	2. Input impedance: voltage input: 20kΩ; current input: 500Ω 3. Resolution: the minimum one is 5mV when 10V corresponds to 50Hz 4. Deviation ±1%, 25°C	
GND	+10V reference null potential	
AO1	1. Output range: 0 (2)-10V or 0 (4)-20mA; AO1 can be shifted by J1; AO2 can be shifted by J2	
AO2	2. Deviation±1%,25°C	
PE	Grounding terminal	
PW	Provide the input switch working power supply from external to internal. Voltage range: 12-30V	
24V	The VFD provides the power supply for users with a maximum output current of 200mA	
S1	Switch input 1	1. Internal impedance: 3.3kΩ 2. 12-30V voltage input is available 3. The terminal is the dual-direction input terminal supporting both NPN and PNP 4. Max input frequency: 1kHz 5. All are programmable digital input terminal. User can set the terminal function through function codes.
S2	Switch input 2	
S3	Switch input 3	
S4	Switch input 4	
S5	Switch input 5	
S6	Switch input 6	
S7	Switch input 7	
S8	Switch input 8	
HDI	Except for S1 - S8, this terminal can be used as high frequency input channel. max. input frequency: 50kHz	
RO1A	RO1 relay output, RO1A NO, RO1B NC, RO1C common terminal Contactor capability: 3A/AC250V,1A/DC30V	
RO1B		
RO1C		

Terminal name	Description
RO2A	RO2 relay output, RO2A NO, RO2B NC, RO2C common terminal Contactor capability: 3A/AC250V,1A/DC30V
RO2B	
RO2C	

4.3.6 Input /Output signal connection figure

Please use U-shaped contact tag to set NPN mode or PNP mode and the internal or external power supply. The default setting is NPN internal mode.

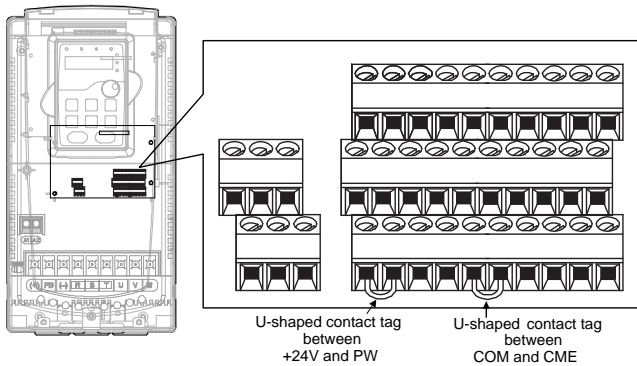

Figure 4-23 U-shaped contact tag

If the signal is from NPN transistor, please set the U-shaped contact tag between +24V and PW as below according to the used power supply.

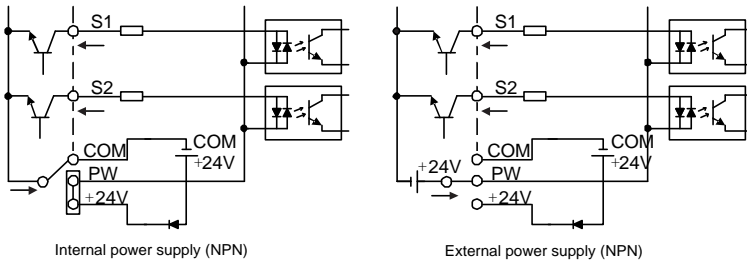

Figure 4-24 NPN modes

If the signal is from PNP transistor, please set the U-shaped contact tag as below according to the used power supply.

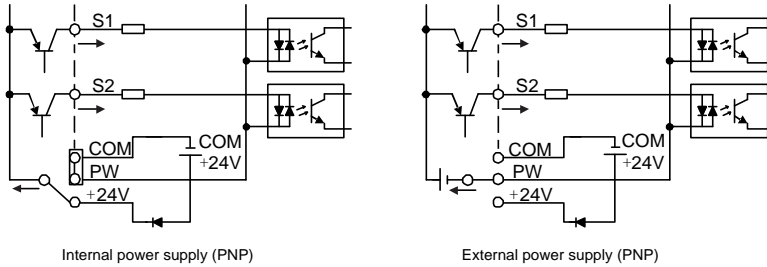

Figure 4-25 PNP modes

4.4 Layout protection

4.4.1 Protecting the VFD and input power cable in short-circuit situations

Protect the VFD and input power cable in short circuit situations and against thermal overload.

Arrange the protection according to the following guidelines.

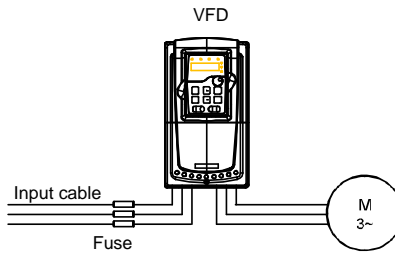

Figure 4-26 Fuse configuration

Note: Select the fuse as the manual indicated. The fuse will protect the input power cable from damage in short-circuit situations. It will protect the surrounding devices when the internal of the VFD is short circuited.

4.4.2 Protecting the motor and motor cable in short-circuit situations

The VFD protects the motor and motor cable in a short-circuit situation when the motor cable is dimensioned according to the rated current of the VFD. No additional protection devices are needed.

	<ul style="list-style-type: none"> ● If the VFD is connected to multiple motors, a separate thermal overload switch or a circuit breaker must be used for protecting each cable and motor. These devices may require a separate fuse to cut off the short-circuit current.
--	---

4.4.3 Protecting the motor against thermal overload

According to regulations, the motor must be protected against thermal overload and the current must be switched off when overload is detected. The VFD includes a motor thermal protection function that protects the motor and closes the output to switch off the current when necessary.

4.4.4 Implementing a bypass connection

It is necessary to set power frequency and variable frequency conversion circuits for the assurance of continuous normal work of the VFD if faults occur in some significant situations.

In some special situations, for example, if it is only used in soft start, the VFD can be converted into power frequency running after starting and some corresponding bypass should be added.



- Never connect the supply power to the VFD output terminals U, V and W. Power line voltage applied to the output can result in permanent damage to the VFD.

If frequent shifting is required, employ mechanically connected switches or contactors to ensure that the motor terminals are not connected to the AC power line and VFD output terminals simultaneously.

5 Keypad operation procedure

5.1 What this chapter contains

This chapter contains following operation:

- Buttons, indicating lights and the screen as well as the methods to inspect, modify and set function codes by keypad
- Start

5.2 Keypad

The keypad is used to control Goodrive200A series VFDs, read the state data and adjust parameters.

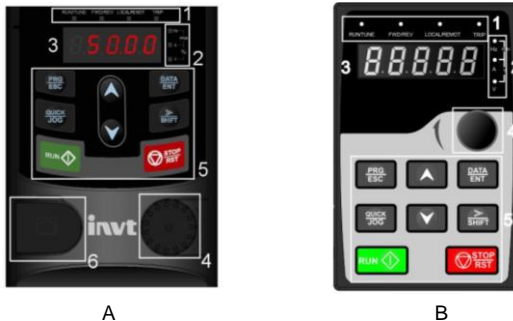
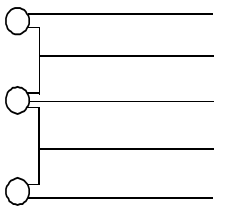









Figure 5-1 Keypad

Note:

- A in Figure 5-1 shows the keypad of the 0R7G–015G/018P models and B in Figure 5-1 shows that of the 018G/022P–500G models.
- The 0R7G–015G/018P models support optional LED keypads and all series support optional LCD keypads. The LCD keypad supports several languages, parameters copy, high-definition display and its installation dimension is compatible with the LED.
- Use screw or installation bracket to fix the external keypad. If you need to use the keypad in another place rather than on the VFD, use a network cable with a standard RJ45 crystal head as the extension cable. The keypad installation brackets are optional for the 0R7G–030G/037P models, while keypad installation brackets are standard configuration for the 037G/045P–500G models.

No.	Name	Description
1	State LED	<p>RUN/TUNE</p> <p>LED off – the VFD is stopped</p> <p>LED blinking – the VFD is in parameter autotune</p> <p>LED on – the VFD is running</p>

No.	Name	Description		
		FWD/REV	LED off – the VFD will run in the forward direction LED on – the VFD will run in the reverse direction	
		LOCAL/REMOT	LED indicates keypad operation, terminal operation and remote communication control LED off – the VFD is in keypad operation mode LED blinking – the VFD is in terminal operation mode LED on – the VFD is in remote operation control mode	
		TRIP	LED for faults LED on – the VFD is faulty LED off – normal state LED blinking – the VFD is in pre-alarm, and will trip soon without corrective actions	
2	Unit LED		Mean the unit displayed currently Hz RPM A % V	Frequency unit Rotation speed unit Current unit Percentage Voltage unit
3	Code displaying zone	5-figure LED display displays various monitoring data and alarm code such as set frequency and output frequency.		
4	Analog potentiometer Digital potentiometer	Equal to AI1. Applicable to the 015G/018P and lower models. Tuning frequency. Please refer to P08.42. Applicable to the 018G/022P and higher models.		
5	Buttons		Programming key	Enter or escape from the first level menu and delete shortcut parameter
			Entry key	Enter the menu step-by-step Confirm parameters

No.	Name	Description		
			UP key	Increase data or function code progressively
			DOWN key	Decrease data or function code progressively
			Right-shift key	Move right to select the displaying parameter circularly in stopping and running mode. Select the parameter modifying digit during the parameter modification
			Run key	This key is used to operate on the VFD in keypad operation mode
			Stop/Reset key	This key is used to stop in running state and it is limited by function code P07.04 This key is used to reset all control modes in the fault alarm state
			Quick key	The function of this key is confirmed by function code P07.02.
6	Keypad interface	The keypad interface is standard configuration for the 015G/018P and lower models.		

5.3 Keypad displaying

The keypad displaying state of Goodrive200A series VFDs is divided into stopping state parameter, running state parameter, function code parameter editing state and fault alarm state and so on.

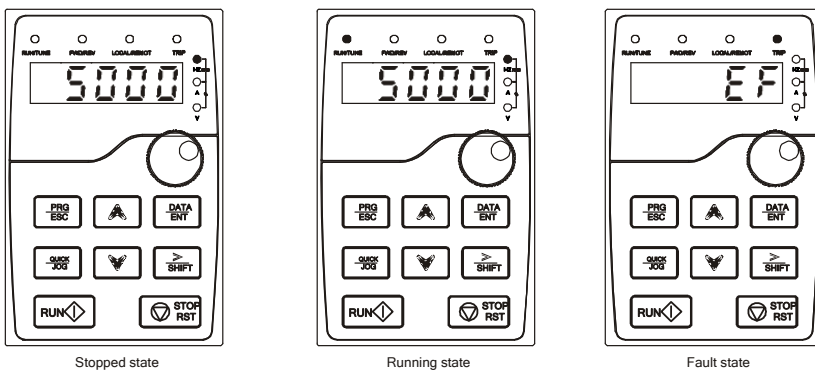

Figure 5-2 Displayed state

5.4 Keypad operation

Operate the VFD via operation panel. See the detailed structure description of function codes in the brief diagram of function codes.

5.4.1 How to modify the function codes of the VFD

The VFD has three levels menu, which are:

1. Group number of function code (first-level menu)
2. Tab of function code (second-level menu)
3. Set value of function code (third-level menu)

Remarks: Press both the **PRG/ESC** and the **DATA/ENT** can return to the second-level menu from the third-level menu. The difference is: pressing **DATA/ENT** will save the set parameters into the control panel, and then return to the second-level menu with shifting to the next function code automatically; while pressing **PRG/ESC** will directly return to the second-level menu without saving the parameters, and keep staying at the current function code.

Under the third-level menu, if the parameter has no flickering bit, it means the function code cannot be modified. The possible reasons could be:

- 1) This function code is not modifiable parameter, such as actual detected parameter, operation records and so on;
- 2) This function code is not modifiable in running state, but modifiable in stop state.

Example: Set function code P00.01 from 0 to 1.

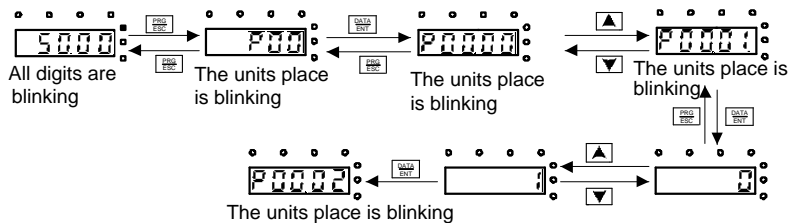

Figure 5-3 Sketch map of modifying parameters

5.4.2 How to set the password of the VFD

Goodrive200A series VFDs provides the user password protection function. When you set P07.00 to a non-zero value, the value is the user password. After you exit the function code editing interface, the password protection function is enabled within 1 minute. If password protection is enabled, "0.0.0.0.0" is displayed when you press the PRG/ESC key again to enter the function code editing

interface. You need to enter the correct user password to enter the interface.

To disable the password protection function, you need only to set P07.00 to 0.

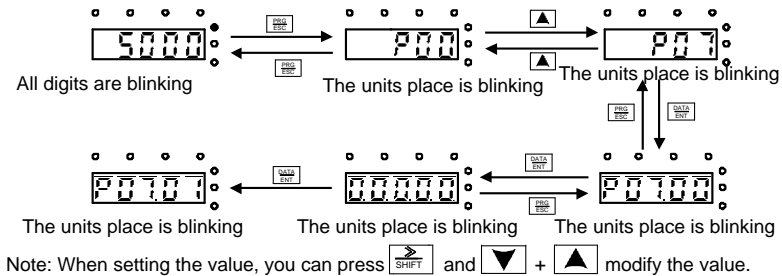

Figure 5-4 Sketch map of password setting

5.4.3 How to watch the VFD state through function codes

Goodrive200A series VFDs provide group P17 as the state inspection group. Users can enter into P17 directly to watch the state.

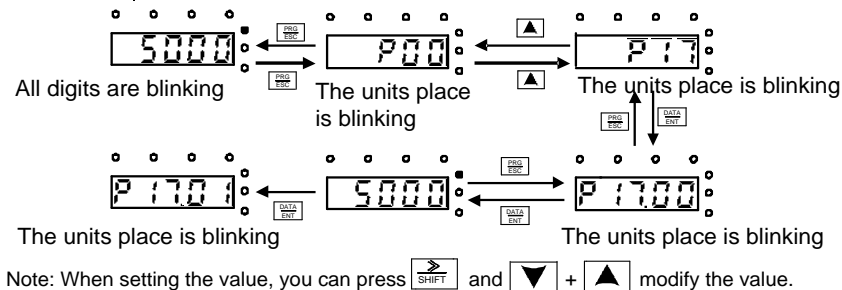

Figure 5-5 Sketch map of state watching

6 Function parameters

6.1 What this chapter contains

This chapter lists and describes the function parameters.

6.2 Goodrive200A general series function parameters

The function parameters of Goodrive200A series VFDs have been divided into 30 groups (P00–P29) according to the function, of which P18 – P28 are reserved. Each function group contains certain function codes applying 3-level menus. For example, "P08.08" means the eighth function code in the P8 group function, P29 group is factory reserved, and users are forbidden to access these parameters.

For the convenience of function codes setting, the function group number corresponds to the first level menu, the function code corresponds to the second level menu and the function code corresponds to the third level menu.

1. Below is the instruction of the function lists:

The first column "Function code": codes of function parameter group and parameters;

The second column "Name": full name of function parameters;

The third column "Description": detailed illustration of the function parameters;

The fourth column "Default value": the original factory set value of the function parameter;

The fifth column "Modify": the modifying character of function codes (the parameters can be modified or not and the modifying conditions), below is the instruction:

"○": means the set value of the parameter can be modified on stop and running state;

"◎": means the set value of the parameter cannot be modified on the running state;

"●": means the value of the parameter is the real detection value which cannot be modified.

(The VFD has limited the automatic inspection of the modifying character of the parameters to help users avoid inadvertent modification).

2. "Parameter radix" is decimal (DEC), if the parameter is expressed by hex, then the parameter is separated from each other when editing. The setting range of certain bits are 0 – F (hex).

3. "The default value" means the function parameter will restore to the default value during default parameters restoring. But the detected parameter or recorded value won't be restored.

4. For a better parameter protection, the VFD provides password protection to the parameters. After setting the password (set P07.00 to any non-zero number), the system will come into the state of password verification firstly after the user press **PRG/ESC** to come into the function code editing state. And then "0.0.0.0.0." will be displayed. Unless the user input right password, they cannot enter

into the system. For the factory setting parameter zone, it needs correct factory password (remind that the users cannot modify the factory parameters by themselves, otherwise, if the parameter setting is incorrect, damage to the VFD may occur). If the password protection is unlocked, the user can modify the password freely and the VFD will work as the last setting one. When P07.00 is set to 0, the password can be canceled. If P07.00 is not 0 during powering on, then the parameter is protected by the password. When modify the parameters by serial communication, the function of the password follows the above rules, too.

P00 Group Basic functions

Function code	Name	Description	Default value	Modify
P00.00	Speed control mode	<p>1: Sensorless vector control mode 1 (applying to AM) No need to install encoders. It is suitable in cases with high speed control accuracy for accurate speed and torque control at all power ratings.</p> <p>2: SVM control No need to install encoders. It can improve the control accuracy with the advantages of stable operation, valid low-frequency torque boost and current vibration suppression and the functions of slip compensation and voltage adjustment.</p> <p>Note: AM-Asynchronous motor</p>	2	☉
P00.01	Run command channel	<p>Select the run command channel of the VFD. The control command of the VFD includes: start, stop, forward, reverse, jogging and fault reset.</p> <p>0: Keypad running command channel("LOCAL/REMOT" light off) Carry out the command control by RUN, STOP/RST on the keypad. Set the multi-function key QUICK/JOG as FWD/REV shifting function (P07.02=3) to change the running direction; press RUN and STOP/RST simultaneously in running state to make the VFD coast to stop.</p> <p>1: Terminal running command channel ("LOCAL/REMOT" flickering) Carry out the running command control by the forward rotation, reverse rotation and forward jogging and reverse jogging of the multi-function terminals</p>	0	○

Function code	Name	Description	Default value	Modify
		2: Communication running command channel ("LOCAL/REMOT" on); The running command is controlled by the upper monitor via communication.		
P00.02	Communication selection	0: MODBUS communication 1–3: Reserved	0	○
P00.03	Max. output frequency	This parameter is used to set the Maximum output frequency of the VFD. Users should pay attention to this parameter because it is the foundation of the frequency setting and the speed of acceleration and deceleration. Setting range: P00.04–400.00Hz	50.00 Hz	◎
P00.04	Upper limit of the running frequency	The upper limit of the running frequency is the upper limit of the output frequency of the VFD which is lower than or equal to the maximum frequency. Setting range: P00.05–P00.03 (max. output frequency)	50.00 Hz	◎
P00.05	Lower limit of the running frequency	The lower limit of the running frequency is that of the output frequency of the VFD. The VFD runs at the lower limit frequency if the set frequency is lower than the lower limit one. Note: Max. output frequency ≥ Upper limit frequency ≥ Lower limit frequency Setting range: 0.00Hz–P00.04 (Upper limit of the running frequency)	0.00 Hz	◎
P00.06	A frequency command	Note: Frequency A and frequency B cannot use the same frequency setting mode. The frequency source can be set by P00.09. 0: Keypad data setting Modify the value of P00.10 (set the frequency by keypad) to modify the frequency by the keypad. 1: Analog AI1 setting (implemented through the analog potentiometer on the keypad for the 0150G/018P and lower models; not available for the 018G/022P and higher models.) 2: Analog AI2 setting 3: Analog AI3 setting	0	○
P00.07	B frequency command		2	○

Function code	Name	Description	Default value	Modify
		<p>Set the frequency by analog input terminals. Goodrive200A series VFDs provide 3 channels analog input terminals as the standard configuration, of which AI1/AI2 are the voltage/current option (0 (2)–10V/0 (4)–20mA) which can be shifted by jumpers; while AI3 is voltage input (-10V→+10V).</p> <p>Note: When analog AI1/AI2 selects 0 (4)–20mA input, the corresponding voltage of 20mA is 10V. 100.0% of the analog input setting corresponds to the maximum frequency (function code P00.03) in forward direction and -100.0% corresponds to the maximum frequency in reverse direction (function code P00.03)</p> <p>4: High-speed pulse HDI setting The frequency is set by high-speed pulse terminals. Goodrive200A series VFDs provide 1 channel high speed pulse input as the standard configuration. The pulse frequency range is 0.00–50.00kHz. 100.0% of the high speed pulse input setting corresponds to the maximum frequency in forward direction (P00.03) and -100.0% corresponds to the maximum frequency in reverse direction (P00.03).</p> <p>Note: The pulse setting can only be input by multi-function terminals HDI. Set P05.00 (HDI input selection) to high speed pulse input.</p> <p>5: Simple PLC program setting The VFD runs at simple PLC program mode when P00.06=5 or P00.07=5. Set P10 (simple PLC and multi-step speed control) to select the running frequency, running direction, ACC/DEC time and the keeping time of corresponding step. See the function description of P10 for detailed information.</p> <p>6: Multi-step speed running setting The VFD runs at multi-step speed mode when</p>		

Function code	Name	Description	Default value	Modify
		<p>P00.06=6 or P00.07=6. Set P05 to select the current running step, and set P10 to select the current running frequency.</p> <p>The multi-step speed has the priority when P00.06 or P00.07 does not equal to 6, but the setting step can only be the 1–15 steps. The setting step is 0–15 if P00.06 or P00.07 equals 6.</p> <p>7: PID control setting</p> <p>The running mode of the VFD is process PID control when P00.06=7 or P00.07=7. It is necessary to set P09. The running frequency of the VFD is the value after PID effect. See P09 for the detailed information of the preset source, preset value, and feedback source of PID.</p> <p>8: MODBUS communication setting</p> <p>The frequency is set by MODBUS communication. See P14 for detailed information.</p> <p>9–11: Reserved</p>		
P00.08	B frequency command reference	<p>0: Maximum output frequency, 100% of B frequency setting corresponds to the maximum output frequency</p> <p>1: A frequency command, 100% of B frequency setting corresponds to the maximum output frequency. Select this setting if it needs to adjust on the base of A frequency command.</p>	0	○
P00.09	Combination of the setting source	<p>0: A, the current frequency setting is A frequency command</p> <p>1: B, the current frequency setting is B frequency command</p> <p>2: A+B, the current frequency setting is A frequency command + B frequency command</p> <p>3: A-B, the current frequency setting is A frequency command - B frequency command</p> <p>4: Max (A, B): the bigger one between A frequency command and B frequency is the set frequency.</p> <p>5: Min (A, B): The lower one between A frequency command and B frequency is the set frequency.</p> <p>Note: The combination manner can be shifted by P05(terminal function)</p>	0	○

Function code	Name	Description	Default value	Modify
P00.10	Keypad set frequency	When A and B frequency commands are selected as "keypad setting", this parameter will be the initial value of VFD reference frequency Setting range: 0.00 Hz–P00.03 (the max. frequency)	50.00 Hz	<input type="radio"/>
P00.11	ACC time 1	ACC time means the time needed if the VFD speeds up from 0Hz to the max. one (P00.03). DEC time means the time needed if the VFD speeds down from the max. output frequency to 0Hz (P00.03).	Model depended	<input type="radio"/>
P00.12	DEC time 1	Goodrive200A series VFDs define four groups of ACC/DEC time which can be selected by P05. The factory default ACC/DEC time of the VFD is the first group. Setting range of P00.11 and P00.12: 0.0–3600.0s	Model depended	<input type="radio"/>
P00.13	Running direction	0: Runs at the default direction, the VFD runs in the forward direction. FWD/REV indicator is off. 1: Runs at the opposite direction, the VFD runs in the reverse direction. FWD/REV indicator is on. Modify the function code to shift the rotation direction of the motor. This effect equals to the shifting the rotation direction by adjusting either two of the motor lines (U, V and W). In keypad control, the motor rotation direction can be changed by QUICK/JOG on the keypad. Refer to parameter P07.02. Note: When the function parameter comes back to the default value, the motor's running direction will come back to the factory default state, too. In some cases it should be used with caution after commissioning if the change of rotation direction is disabled. 2: Forbid to run in reverse direction: It can be used in some special cases if the reverse running is disabled.	0	<input type="radio"/>

Function code	Name	Description	Default value	Modify																								
P00.14	Carrier frequency setting	<table border="1"> <thead> <tr> <th>Carrier frequency</th> <th>Electro magnetic noise</th> <th>Noise and leakage current</th> <th>Heating eliminating</th> </tr> </thead> <tbody> <tr> <td>1kHz</td> <td>↑ High</td> <td>↑ Low</td> <td>↑ Low</td> </tr> <tr> <td>10kHz</td> <td>↕</td> <td>↕</td> <td>↕</td> </tr> <tr> <td>15kHz</td> <td>↓ Low</td> <td>↓ High</td> <td>↓ High</td> </tr> </tbody> </table> <p>Mapping between models and carrier frequencies:</p> <table border="1"> <thead> <tr> <th>Model</th> <th>Factory setting of carrier frequency</th> </tr> </thead> <tbody> <tr> <td>0R7G-011G/015P</td> <td>8kHz</td> </tr> <tr> <td>015G/018P-055G/075P</td> <td>4kHz</td> </tr> <tr> <td>075G/090P and higher</td> <td>2kHz</td> </tr> </tbody> </table> <p>The advantage of high carrier frequency: ideal current waveform, little current harmonic wave and motor noise. The disadvantage of high carrier frequency: increasing the switch loss, increasing VFD temperature and the impact to the output capacity. The VFD needs to derate on high carrier frequency. At the same time, the leakage and electrical magnetic interference will increase. Applying low carrier frequency is contrary to the above, too low carrier frequency will cause unstable running, torque decreasing and surge. The manufacturer has set a reasonable carrier frequency when the VFD is in factory. In general, users do not need to change the parameter. When the frequency used exceeds the default carrier frequency, the VFD needs to derate 10% for each additional 1k carrier frequency. Setting range: 1.0-15.0kHz</p>	Carrier frequency	Electro magnetic noise	Noise and leakage current	Heating eliminating	1kHz	↑ High	↑ Low	↑ Low	10kHz	↕	↕	↕	15kHz	↓ Low	↓ High	↓ High	Model	Factory setting of carrier frequency	0R7G-011G/015P	8kHz	015G/018P-055G/075P	4kHz	075G/090P and higher	2kHz	Model depended	○
Carrier frequency	Electro magnetic noise	Noise and leakage current	Heating eliminating																									
1kHz	↑ High	↑ Low	↑ Low																									
10kHz	↕	↕	↕																									
15kHz	↓ Low	↓ High	↓ High																									
Model	Factory setting of carrier frequency																											
0R7G-011G/015P	8kHz																											
015G/018P-055G/075P	4kHz																											
075G/090P and higher	2kHz																											
P00.15	Motor parameter autotuning	0: No operation 1: Rotation autotuning Comprehensive motor parameter autotune	0	◎																								

Function code	Name	Description	Default value	Modify
		It is recommended to use rotation autotuning when high control accuracy is needed. 2: Static autotuning 1 It is suitable in the cases when the motor cannot de-couple from the load. 3: Static autotuning 2 It is suitable in the cases when the motor cannot de-couple from the load. But only for parts of parameters.		
P00.16	AVR function selection	0: Invalid 1: Valid during the whole procedure The auto-adjusting function of the VFD can cancel the impact on the output voltage of the VFD because of the bus voltage fluctuation.	1	○
P00.17	VFD type	0: G type, for the constant torque load of rated parameters 1: P type; for the variable torque load of rated parameters (fans and water pumps) GD200A series VFDs can use G/P type, the available motor power of G type is small one power file than that of P type.	0	◎
P00.18	Function restore parameter	0: No operation 1: Restore the default value 2: Clear fault records 3: Lock the keypad 4: Reserved 5: Restore default values (standard version) 6: Restore default values (motor parameters included) Note: The function code is restored to 0 after the operation corresponding to the selected option is performed. Restoring to the default value will cancel the user password. Exercise caution before using this function. When P00.18=3, all the other function codes except P00.18 are read only.	0	◎

Function code	Name	Description	Default value	Modify
		For non-standard software version, the option 1 restores parameters to non-standard version while the option 5 restores parameters to the corresponding standard version. For standard software version, the option 1 and option 5 are the same.		

P01 Group Start and stop control

Function code	Name	Description	Default value	Modify
P01.00	Start mode	<p>0: Start directly: start from the starting frequency P01.01</p> <p>1: Start after DC braking: start the motor from the starting frequency after DC braking (set the parameter P01.03 and P01.04). It is suitable in the cases where reverse rotation may occur to the low inertia load during starting.</p> <p>2: Start after speed tracking 1</p> <p>3: Start after speed tracking 2</p> <p>Start the rotating motor smoothly after tracking the rotation speed and direction automatically. It is suitable in the cases where reverse rotation may occur to the big inertia load during starting.</p> <p>Note: This function is available for the 004G/5R5P and higher models.</p>	0	☉
P01.01	Starting frequency of direct start	Starting frequency of direct start means the original frequency during the VFD starting. See P01.02 for detailed information. Setting range: 0.00–50.00Hz	0.50 Hz	☉
P01.02	Retention time of the starting frequency	Set a proper starting frequency to increase the torque of the VFD during starting. During the retention time of the starting frequency, the output frequency of the VFD is the starting frequency. And then, the VFD will run from the starting frequency to the set frequency. If the set frequency is lower than the starting frequency, the VFD will stop running and keep in the stand-by	0.0s	☉

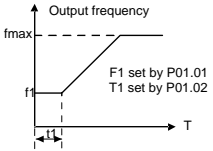
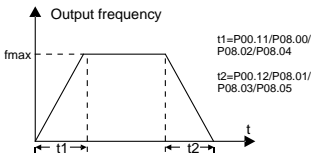
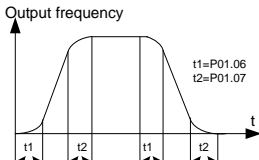
Function code	Name	Description	Default value	Modify
		<p>state. The starting frequency is not limited in the lower limit frequency.</p>  <p>Setting range: 0.0-50.0s</p>		
P01.03	The braking current before starting	<p>The VFD will carry out DC braking at the braking current set before starting and it will speed up after the DC braking time. If the DC braking time is set to 0, the DC braking is invalid.</p>	0.0%	☉
P01.04	The braking time before starting	<p>The stronger the braking current, the bigger the braking power. The DC braking current before starting means the percentage of the rated output current of the VFD.</p> <p>Setting range of P01.03: 0.0-100.0% Setting range of P01.04: 0.00-50.00s</p>	0.00s	☉
P01.05	ACC/DEC selection	<p>The changing mode of the frequency during start and running.</p> <p>0: Linear type The output frequency increases or decreases linearly.</p>  <p>1: S curve: Output frequency increases/decreases gradually based on S curve. S curve is used in cases where smooth start/stop is required, such as elevator, conveyer belt, etc.</p> 	0	☉

Function code	Name	Description	Default value	Modify
P01.06	ACC time of the starting step of S curve	Setting rage: 0.0–50.0s Note: Effective when P01.05 = 1	0.1s	<input type="radio"/>
P01.07	DEC time of the ending step of S curve		0.1s	<input type="radio"/>
P01.08	Stop mode	0: Decelerate to stop: after the stop command becomes valid, the VFD decelerates to reduce the output frequency during the set time. When the frequency decreases to 0Hz, the VFD stops. 1: Coast to stop: after the stop command becomes valid, the VFD ceases the output immediately. And the load coasts to stop at the mechanical inertia.	0	<input type="radio"/>
P01.09	Starting frequency of DC braking	Starting frequency of DC braking: start the DC braking when running frequency reaches starting frequency determined by P01.09.	0.00 Hz	<input type="radio"/>
P01.10	Waiting time before DC braking	Waiting time before DC braking: VFDs block the output before starting the DC braking. After this waiting time, the DC braking will be started so as to prevent over-current fault caused by DC braking at high speed.	0.00s	<input type="radio"/>
P01.11	DC braking current	DC braking current: The value of P01.11 is the percentage of rated current of VFD. The bigger the DC braking current is, the greater the braking torque is. DC braking time: The retention time of DC brake. If the time is 0, the DC brake is invalid. The VFD will stop at the set deceleration time.	0.0%	<input type="radio"/>
P01.12	DC braking time		0.00s	<input type="radio"/>

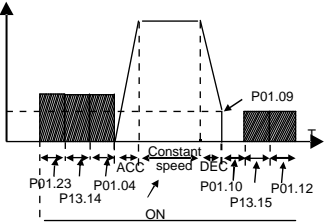

Setting range of P01.09: 0.00Hz–P00.03 (the max. frequency)

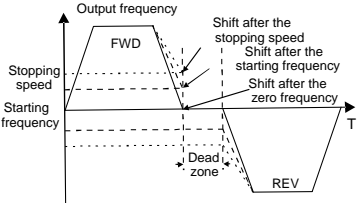
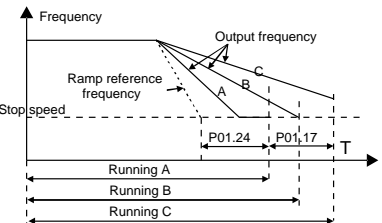
Function code	Name	Description	Default value	Modify
		Setting range of P01.10 : 0.00–50.00s Setting range of P01.11 : 0.0–100.0% (corresponding to the rated output current of the VFD) Setting range of P01.12 : 0.00–50.00s		
P01.13	Dead time of FWD/REV rotation	During the procedure of switching FWD/REV rotation, set the threshold by P01.14 , which is as the table below:  Setting range: 0.0–3600.0s	0.0s	○
P01.14	Shifting between FWD/REV rotation	Set the threshold point of the VFD: 0: Switch after 0 frequency 1: Switch after the starting frequency 2: Switch after the stopping speed	1	◎
P01.15	Stopping speed	0.00–100.00Hz	0.50 Hz	◎
P01.16	Detection of stopping speed	0: Detect according to speed setting (no stopping delay) 1: Detect according to speed feedback (only valid for vector control)	1	◎
P01.17	Detection time of the feedback speed	If P01.16 is set to 1, the feedback frequency is less than or equal to P01.15 and detect in the set time of P01.17 , the VFD will stop; otherwise the VFD will stop after the set time of P01.17 .  Setting range: 0.00–100.00s (only valid when P01.16 =1)	0.50s	◎

Function code	Name	Description	Default value	Modify
P01.18	Operation protection during powering on	<p>When the running command channel is the terminal control, the system will detect the state of the running terminal during powering on.</p> <p>0: The terminal running command is invalid when powering on. Even the running command is detected to be valid during powering on, the VFD won't run and the system keeps in the protection state until the running command is canceled and enabled again.</p> <p>1: The terminal running command is valid when powering on. If the running command is detected to be valid during powering on, the system will start the VFD automatically after the initialization.</p> <p>Note: This function should be selected with cautions, or serious result may follow.</p>	0	○
P01.19	Action selection when running frequency is lower than lower limit of frequency (valid when low limit of frequency is larger than 0)	<p>This function code determines the running state of the VFD when the set frequency is lower than the lower-limit one.</p> <p>Ones place: Action selection</p> <p>0: Run at the frequency lower limit</p> <p>1: Stop</p> <p>2: Hibernation</p> <p>Tens place: Stop mode</p> <p>0: Coast to stop</p> <p>1: Decelerate to stop</p> <p>The VFD will sleeps or stops as set in Tens place when the set frequency is lower than the lower-limit one and the hibernation delay time (P08.22) is reached. If the set frequency is above the lower limit one again and it lasts for the time set by P01.20, the VFD will come back to the running state automatically.</p> <p>3: Sleep and standby 2</p> <p>Select sleep and standby 2: When the running frequency is no more than lower limit frequency (P00.05), it is required to judge P24.05 continuously before entering sleep state.</p> <p>Setting range: 0x00–0x13</p>	0	◎

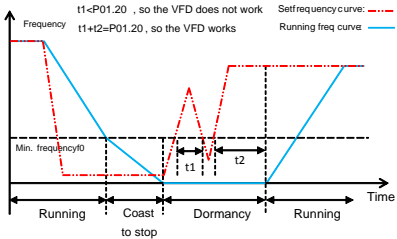
Function code	Name	Description	Default value	Modify
P01.20	Wake-up-from-sleep delay	<p>This function code determines the wake-up-from-sleep delay. When the running frequency of the VFD is lower than the lower limit one, the VFD will pause to stand by. When the set frequency is above the lower limit one again and it lasts for the time set by P01.20, the VFD will run automatically.</p> <p>Note: The time is the total value when the set frequency is above the lower limit one.</p>  <p>Setting range: 0.0–3600.0s (valid when P01.19=2)</p>	0.0s	○
P01.21	Restart after power off	<p>This function can enable the VFD start or not after the power off and then power on.</p> <p>0: Disable 1: Enable, if the starting need is met, the VFD will run automatically after waiting for the time defined by P01.22.</p>	0	○
P01.22	The waiting time of restart after power off	<p>The function determines the waiting time before the automatic running of the VFD when powering off and then powering on.</p> <p>Setting range: 0.0–3600.0s (valid when P01.21=1)</p>	1.0s	○
P01.23	Start delay time	<p>The function determines the brake release after the running command is reference, and the VFD is in a stand-by state and the delay time set by P01.23 to wait.</p> <p>Setting range: 0.0–60.0s</p>	0.0s	○

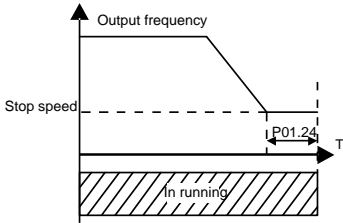
Function code	Name	Description	Default value	Modify
P01.24	Delay time of the stop speed	 <p>Setting range: 0.0–100.0 s</p>	0.0s	●
P01.25	0Hz output selection	0: Output without voltage 1: Output with voltage 2: Output at the DC braking current	0	●

P02 Group Motor 1

Function code	Name	Description	Default value	Modify	
P02.01	Rated power of AM 1	0.1–3000.0kW	To ensure control performance, set P02.01–P02.05 according to the AM nameplate.	Model depended	⊙
P02.02	Rated frequency of AM 1	0.01Hz– P00.03 (the max. frequency)	Goodrive200A provides the parameter self-learning function.	50.00 Hz	⊙
P02.03	Rated speed of AM 1	1–36000rpm	Accurate parameter self-learning is based on the correct settings of motor nameplate parameters.	Model depended	⊙
P02.04	Rated voltage of AM 1	0–1200V	Perform motor configuration according to the mapping between VFDs and motors. If the motor power is far from the power of the motor that matches the VFD, the control performance of the VFD deteriorates sharply.	Model depended	⊙
P02.05	Rated current of AM 1	0.8–6000.0A	Note: Resetting the rated motor power (P02.01) will initialize P02.02–P02.10 .	Model depended	⊙
P02.06	Stator resistor of AM 1	0.001–65.535Ω	After motor parameter self-learning is completed	Model depended	○

Function code	Name	Description		Default value	Modify
P02.07	Rotor resistor of AM 1	0.001–65.535Ω	successfully, in rotary self-learning and static	Model depended	○
P02.08	Leakage inductance of AM 1	0.1–6553.5mH	self-learning 1, the settings of P02.06–P02.10 can be updated automatically. In static	Model depended	○
P02.09	Mutual inductance of AM 1	0.1–6553.5mH	self-learning mode 2, the settings of P02.06–P02.08 can be updated automatically. These	Model depended	○
P02.10	Non-load current of AM 1	0.1–6553.5A	parameters are the basic parameters for the VFD to control the motor and have direct impact on control performance. Note: Exercise caution before modifying these parameters.	Model depended	○
P02.26	Motor 1 overload protection	<p>0: No protection</p> <p>1: Common motor (with low speed compensation). Because the heat-releasing effect of the common motors will be weakened, the corresponding electric heat protection will be adjusted properly. The low speed compensation characteristic mentioned here means reducing the threshold of the overload protection of the motor whose running frequency is below 30Hz.</p> <p>2: Variable frequency motor (without low speed compensation) Because the heat-releasing effect of the specific motors won't be impacted by the rotation speed, it is not necessary to adjust the protection value during low-speed running.</p>		2	◎
P02.27	Motor 1 overload protection coefficient	<p>Times of motor overload $M = I_{out}/(I_n \cdot K)$</p> <p>$I_n$ is the rated current of the motor, I_{out} is the output current of the VFD and K is the motor protection coefficient.</p> <p>So, the bigger the value of K is, the smaller the value of M is. When $M=116\%$, protection is performed after motor overload lasts for 1 hour; when $M=150\%$, protection is performed after motor overload lasts for 12 minutes; when $M=180\%$, protection is performed after motor</p>		100.0%	○

Function code	Name	Description	Default value	Modify
		<p>overload lasts for 5 minutes; when M=200%, protection is performed after motor overload lasts for 60 seconds; and when $M \geq 400\%$, protection is performed immediately.</p> <p>Setting range: 20.0%–120.0%</p>		
P02.28	Correction coefficient of motor 1 power	<p>Correct the power displaying of motor 1. Only impact the displaying value other than the control performance of the VFD.</p> <p>Setting range: 0.00–3.00</p>	1.00	●

P03 Group Vector control

Function code	Name	Description	Default value	Modify
P03.00	Speed loop proportional gain1	<p>The parameters P03.00–P03.05 only apply to vector control mode. Below the switching frequency 1 (P03.02), the speed loop PI parameters are: P03.00 and P03.01. Above the switching frequency 2 (P03.05), the speed loop PI parameters are: P03.03 and P03.04. PI parameters are gained according to the linear change of two groups of parameters. It is shown as below:</p>	20.0	○
P03.01	Speed loop integral time1		0.200s	○
P03.02	Low switching frequency		5.00 Hz	○
P03.03	Speed loop proportional gain 2		20.0	○
P03.04	Speed loop integral time 2		0.200s	○
P03.05	High switching frequency		10.00 Hz	○

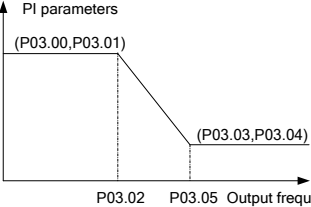
Function code	Name	Description	Default value	Modify
		 <p>Setting the proportional coefficient and integral time of the adjustor can change the dynamic response performance of vector control speed loop. Increasing the proportional gain and decreasing the integral time can speed up the dynamic response of the speed loop. But too high proportional gain and too low integral time may cause system vibration and overshoot. Too low proportional gain may cause system vibration and speed static deviation.</p> <p>PI has a close relationship with the inertia of the system. Adjust on the base of PI according to different loads to meet various demands.</p> <p>Setting range of P03.00: 0–200.0 Setting range of P03.01: 0.000–10.000s Setting range of P03.02: 0.00Hz–P03.05 Setting range of P03.03: 0–200.0 Setting range of P03.04: 0.000–10.000s Setting range of P03.05: P03.02–P00.03 (the max. output frequency)</p>		
P03.06	Speed loop output filter	0–8 (corresponds to 0–2 ⁸ /10ms)	0	○
P03.07	Compensation coefficient of electro motion slip	Slip compensation coefficient is used to adjust the slip frequency of the vector control and improve the speed control accuracy of the system.	100%	○
P03.08	Compensation coefficient of braking slip	Adjusting the parameter properly can control the speed steady-state error. Setting range: 50–200%	100%	○
P03.09	Current loop percentage coefficient P	Note: 1 These two parameters adjust the PI adjustment parameter of the current loop which affects the	1000	○

Function code	Name	Description	Default value	Modify
P03.10	Current loop integral coefficient 1	dynamic response speed and control accuracy directly. Generally, users do not need to change the default value. 2 Only apply to SVC control mode 0 (P00.00=0). Setting range: 0–65535	1000	○
P03.11	Torque setting method	This parameter is used to enable the torque control mode, and set the torque. 0: Torque control is invalid 1: Keypad setting torque (P03.12) 2: Analog AI1 setting torque (implemented through the analog potentiometer on the keypad for the 0150G/018P and lower models; not available for the 018G/022P and higher models.) 3: Analog AI2 setting torque 4: Analog AI3 setting torque 5: Pulse frequency HDI setting torque 6: Multi-step torque setting 7: MODBUS communication setting torque 8–10: Reserved Note: For setting modes 2–5, 100% corresponds to three times of the rated current of the motor.	0	○
P03.12	Keypad setting torque	Setting range: -300.0%–300.0% (rated current of the motor)	50.0%	○
P03.13	Torque reference filter time	0.000–10.000s	0.010s	○
P03.14	Upper frequency of forward rotation in vector control	0: Keypad (P03.16 sets P03.14, P03.17 sets P03.15) 1: AI1 (implemented through the analog potentiometer on the keypad for the 0150G/018P and lower models; not available for the 018G/022P and higher models.)	0	○
P03.15	Upper frequency of reverse rotation in vector control	2: AI2 3: AI3 4: Pulse frequency HDI setting upper-limit frequency 5: Multi-step setting upper-limit frequency 6: MODBUS communication setting upper-limit frequency Note: For setting method 1–6, 100% corresponds to the maximum frequency	0	○

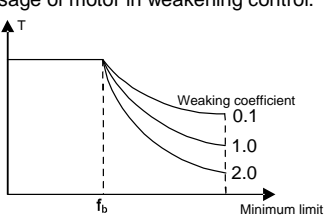
Function code	Name	Description	Default value	Modify
P03.16	Keypad setting for upper frequency of forward rotation	This function is used to set the upper limit of the frequency. P03.16 sets the value of P03.14; P03.17 sets the value of P03.15. Setting range: 0.00 Hz–P00.03 (the max. output frequency)	50.00 Hz	<input type="radio"/>
P03.17	Keypad setting for upper frequency of reverse rotation		50.00 Hz	<input type="radio"/>
P03.18	Upper electro motion torque source	This function code is used to select the electro motion and braking torque upper-limit setting source selection.	0	<input type="radio"/>
P03.19	Upper braking torque source	0: Keypad setting upper-limit frequency (P03.20 sets P03.18, P03.21 sets P03.19) 1: AI1 (implemented through the analog potentiometer on the keypad for the 0150G/018P and lower models; not available for the 018G/022P and higher models.) 2: AI2 3: AI3 4: HDI 5: MODBUS communication Note: For setting mode 1–4, 100% corresponds to three times of the motor current.	0	<input type="radio"/>
P03.20	Keypad setting of electromotion torque	The function code is used to set the limit of the torque. Setting range: 0.0–300.0% (rated motor current)	180.0%	<input type="radio"/>
P03.21	Keypad setting of braking torque		180.0%	<input type="radio"/>
P03.22	Weakening coefficient in constant power zone	The usage of motor in weakening control. 	0.3	<input type="radio"/>
P03.23	Lowest weakening point in constant power		20%	<input type="radio"/>

Function code	Name	Description	Default value	Modify
	zone	Function codes P03.22 and P03.23 are effective at constant power. The motor will enter into the weakening state when the motor runs at rated speed. Change the weakening curve by modifying the weakening control coefficient. The bigger the weakening control coefficient is, the steeper the weak curve is. Setting range of P03.22 : 0.1–2.0 Setting range of P03.23 : 10%–100%		
P03.24	Max. voltage limit	P03.24 sets the max. voltage of the VFD, which is dependent on the site situation. The setting range: 0.0–120.0%	100.0%	☉
P03.25	Pre-exciting time	Reactivate the motor when the VFD starts up. Build up a magnetic field inside the VFD to improve the torque performance during the starting process. The setting time: 0.000–10.000s	0.300s	○
P03.26	Weak magnetic proportional gain	0–8000 Note: P03.24 – P03.26 are invalid for vector mode.	1000	○
P03.27	Vector control speed	0: Display the actual value 1: Display the setting value	0	○
P03.28	Compensation coefficient of static friction	0.0–100.0% Adjust P03.28 to compensate the coefficient of static friction. Only valid when setting in 1Hz.	0.0%	○
P03.29	Compensation coefficient of dynamic friction	0.0–100.0% Adjust P03.29 to compensate the coefficient of static friction. Only valid when setting in 1Hz.	0.0%	○

P04 Group SVPWM control

Function code	Name	Description	Default value	Modify
P04.00	Motor 1 V/F curve setting	These function codes define the V/F curve of Goodrive200A motor 1, and meet the need of different loads. 0: Straight line V/F curve; applying to the constant torque load	0	☉

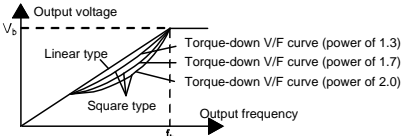
Function code	Name	Description	Default value	Modify
		<p>1: Multi-dots V/F curve 2: Torque down V/F curve (power of 1.3) 3: Torque down V/F curve (power of 1.7) 4: Torque down V/F curve (power of 2.0)</p> <p>Curves 2–4 apply to the torque loads such as fans and water pumps. Users can adjust according to the features of the loads to achieve a best energy-saving effect.</p> <p>5: Customized V/F (V/F separation); in this mode, V can be separated from f and f can be adjusted through the frequency reference channel set by P00.06 or the voltage reference channel set by P04.27 to change the feature of the curve.</p> <p>Note: V_b in the below picture is the motor rated voltage and f_b is the motor rated frequency.</p> 		
P04.01	Motor 1 torque boost	<p>Torque boost is used for the compensation of low frequency torque. P04.01 is relative to the max. output voltage V_b.</p> <p>P04.02 defines the percentage of closing frequency of manual torque to f_b.</p> <p>Torque boost should be selected according to the load. The bigger the load is, the bigger the torque is. Too big torque boost is inappropriate because the motor will run with over magnetic, and the current of the VFD will increase to add the temperature of the VFD and decrease the efficiency.</p>	0.0%	○
P04.02	Motor 1 torque boost close	<p>When the torque boost is set to 0.0%, the VFD is automatic torque boost.</p> <p>Torque boost threshold: below this frequency point, the torque boost is effective, but over this frequency point, the torque boost is invalid.</p>	20.0%	○

Function code	Name	Description	Default value	Modify
		<p>Setting range of P04.01: 0.0%: (automatic) 0.1%–10.0% Setting range of P04.02: 0.0%–50.0%</p>		
P04.03	V/F frequency 1 of motor 1	<p>When P04.00=1, the user can set V/F curve through P04.03–P04.08. V/F is generally set according to the load of the motor. Note: V1 < V2 < V3, f1 < f2 < f3. Too high low frequency voltage will heat the motor excessively or damage. The overcurrent speed or overcurrent protection may occur to the VFD.</p>	0.00 Hz	<input type="radio"/>
P04.04	V/F voltage 1 of motor 1		00.0%	<input type="radio"/>
P04.05	V/F frequency 2 of motor 1		00.00 Hz	<input type="radio"/>
P04.06	V/F voltage 2 of motor 1		00.0%	<input type="radio"/>
P04.07	V/F frequency 3 of motor 1		00.00 Hz	<input type="radio"/>
P04.08	V/F voltage 3 of motor 1	<p>Setting range of P04.03: 0.00Hz–P04.05 Setting range of P04.04: 0.0%–110.0% Setting range of P04.05: P04.03–P04.07 Setting range of P04.06: 0.0%–110.0% (the rated voltage of motor 1) Setting range of P04.07: P04.05–P02.02 (the rated frequency of motor 1) Setting range of P04.08: 0.0%–110.0% (the rated voltage of motor 1)</p>	00.0%	<input type="radio"/>
P04.09	V/F slip compensation gain of motor 1	<p>This function code is used to compensate the change of the rotation speed caused by load during compensation SVPWM control to improve the rigidity of the motor. It can be set to the rated slip frequency of the motor which is counted as below: $\Delta f = f_b - n \cdot p / 60$</p>	100.0%	<input type="radio"/>

Function code	Name	Description	Default value	Modify
		Of which, f_b is the rated frequency of the motor, its function code is P02.02; n is the rated rotating speed of the motor and its function code is P02.03; p is the pole pair of the motor. 100.0% corresponds to the rated slip frequency Δf . Setting range: 0.0–200.0%		
P04.10	Motor 1 low frequency vibration control factor	In the SVPWM control mode, current fluctuation may occur to the motor on some frequency, especially the motor with big power. The motor cannot run stably or overcurrent may occur. These phenomena can be canceled by adjusting this parameter. Setting range of P04.10: 0–100 Setting range of P04.11: 0–100 Setting range of P04.12: 0.00Hz–P00.03 (the max. frequency)	10	<input type="radio"/>
P04.11	Motor 1 high frequency vibration control factor		10	<input type="radio"/>
P04.12	Motor 1 vibration control threshold		30.00 Hz	<input type="radio"/>
P04.26	Energy-saving operation selection	0: No action 1: Automatic energy-saving operation Motor on the light load conditions, automatically adjusts the output voltage to save energy	0	<input checked="" type="radio"/>
P04.27	Voltage setting channel	Select the output setting channel at V/F curve separation. 0: Keypad setting voltage: the output voltage is determined by P04.28. 1: AI1 setting voltage (implemented through the analog potentiometer on the keypad for the 0150G/018P and lower models; not available for the 018G/022P and higher models.) 2: AI2 setting voltage; 3: AI3 setting voltage; 4: HDI setting voltage; 5: Multi-step speed setting voltage; 6: PID setting voltage; 7: MODBUS communication setting voltage; Note: 100% corresponds to the rated voltage of the motor.	0	<input type="radio"/>

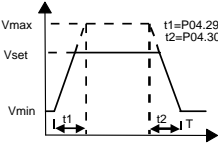
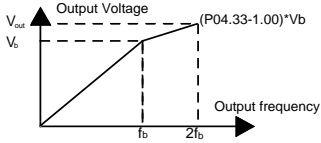
Function code	Name	Description	Default value	Modify
P04.28	Keypad setting voltage	The function code is the voltage digital set value when the voltage setting channel is selected as "keypad selection" The setting range: 0.0%–100.0%	100.0%	○
P04.29	Voltage increasing time	Voltage increasing time is the time when the VFD accelerates from the output minimum voltage to the output maximum voltage.	5.0s	○
P04.30	Voltage decreasing time	Voltage decreasing time is the time when the VFD decelerates from the output maximum voltage to the output minimum voltage. The setting range: 0.0–3600.0s	5.0s	○
P04.31	Maximum output voltage	Set the upper and low limit of the output voltage. Setting range of P04.31: P04.32–100.0%	100.0%	◎
P04.32	Minimum output voltage	(the rated voltage of the motor) Setting range of P04.32: 0.0%–P04.31 (the rated voltage of the motor) 	0.0%	◎
P04.33	Flux weakening coefficient at constant power	Used to adjust the output voltage of VFD in SVPWM mode during flux weakening. Note: Invalid in constant-torque mode. 	1.00	●
P04.34	Reserved			

P05 Group Input terminals

Function code	Name	Description	Default value	Modify
P05.00	HDI input	0: HDI is high pulse input. See P05.50–P05.54 1: HDI is switch input	0	◎

Function code	Name	Description	Default value	Modify
P05.01	S1 terminal function selection	0: No function 1: Forward rotation 2: Reverse rotation	1	☉
P05.02	S2 terminal function selection	3: 3-wire control 4: Forward jogging 5: Reverse jogging	4	☉
P05.03	S3 terminal function selection	6: Coast to stop 7: Fault reset 8: Operation pause 9: External fault input	7	☉
P05.04	S4 terminal function selection	10: Increasing frequency setting(UP) 11: Decreasing frequency setting(DOWN) 12: Cancel the frequency change setting	0	☉
P05.05	S5 terminal function selection	13: Shift between A setting and B setting 14: Shift between combination setting and A setting 15: Shift between combination setting and B setting	0	☉
P05.06	S6 terminal function selection	16: Multi-step speed terminal 1 17: Multi-step speed terminal 2	0	☉
P05.07	S7 terminal function selection	18: Multi-step speed terminal 3 19: Multi- step speed terminal 4 20: Multi- step speed pause	0	☉
P05.08	S8 terminal function selection	21: ACC/DEC time option terminal 1 22: ACC/DEC time option terminal 2 23: Simple PLC stop reset 24: Simple PLC pause	0	☉
P05.09	HDI terminal function selection	25: PID control pause 26: Traverse Pause(stop at the current frequency) 27: Traverse reset(return to the center frequency) 28: Counter reset 29: Torque control prohibition 30: ACC/DEC prohibition 31: Counter trigger 32: Length reset 33: Cancel the frequency change setting temporarily 34: DC brake 36: Shift the command to the keypad 37: Shift the command to the terminals 38: Shift the command to the communication	0	☉

Function code	Name	Description	Default value	Modify																				
		39: Pre-exciting command 40: Clear the power consumption 41: Keep the power consumption 61: PID pole switching When the terminal acts as acceleration/ deceleration time selection function, it is required to select four groups of acceleration/deceleration time via state combination of these two terminal (while terminal 1 choose 21, terminal 2 choose 22)																						
		<table border="1"> <thead> <tr> <th>Terminal1 (21)</th> <th>Terminal2 (22)</th> <th>ACC/DEC time selection</th> <th>Parameters</th> </tr> </thead> <tbody> <tr> <td>OFF</td> <td>OFF</td> <td>ACC/DEC time 1</td> <td>P00.11/P00.12</td> </tr> <tr> <td>ON</td> <td>OFF</td> <td>ACC/DEC time 2</td> <td>P08.00/P08.01</td> </tr> <tr> <td>OFF</td> <td>ON</td> <td>ACC/DEC time 3</td> <td>P08.02/P08.03</td> </tr> <tr> <td>ON</td> <td>ON</td> <td>ACC/DEC time 4</td> <td>P08.04/P08.05</td> </tr> </tbody> </table>	Terminal1 (21)	Terminal2 (22)	ACC/DEC time selection	Parameters	OFF	OFF	ACC/DEC time 1	P00.11/P00.12	ON	OFF	ACC/DEC time 2	P08.00/P08.01	OFF	ON	ACC/DEC time 3	P08.02/P08.03	ON	ON	ACC/DEC time 4	P08.04/P08.05		
Terminal1 (21)	Terminal2 (22)	ACC/DEC time selection	Parameters																					
OFF	OFF	ACC/DEC time 1	P00.11/P00.12																					
ON	OFF	ACC/DEC time 2	P08.00/P08.01																					
OFF	ON	ACC/DEC time 3	P08.02/P08.03																					
ON	ON	ACC/DEC time 4	P08.04/P08.05																					
P05.10	Polarity selection of the input terminals	The function code is used to set the polarity of the input terminals. Set the bit to 0, the input terminal is anode. Set the bit to 1, the input terminal is cathode.	0x000	○																				
		<table border="1"> <tbody> <tr> <td>BIT0</td> <td>BIT1</td> <td>BIT2</td> <td>BIT3</td> <td>BIT4</td> </tr> <tr> <td>S1</td> <td>S2</td> <td>S3</td> <td>S4</td> <td>S5</td> </tr> <tr> <td>BIT5</td> <td>BIT6</td> <td>BIT7</td> <td>BIT8</td> <td></td> </tr> <tr> <td>S6</td> <td>S7</td> <td>S8</td> <td>HDI</td> <td></td> </tr> </tbody> </table> The setting range: 0x000–0x1FF	BIT0	BIT1	BIT2	BIT3	BIT4	S1	S2	S3	S4	S5	BIT5	BIT6	BIT7	BIT8		S6	S7	S8	HDI			
BIT0	BIT1	BIT2	BIT3	BIT4																				
S1	S2	S3	S4	S5																				
BIT5	BIT6	BIT7	BIT8																					
S6	S7	S8	HDI																					
P05.11	ON-OFF filter time	Set the sample filter time of S1–S8 and HDI terminals. If the interference is strong, increase the parameter to avoid the disoperation. 0.000–1.000s	0.010s	○																				
P05.12	Virtual terminals setting	0x000–0x1FF(0: Disabled, 1: Enabled) BIT0: S1 virtual terminal BIT1: S2 virtual terminal BIT2: S3 virtual terminal BIT3: S4 virtual terminal BIT4: S5 virtual terminal BIT5: S6 virtual terminal BIT6: S7 virtual terminal BIT7: S8 virtual terminal BIT8: HDI virtual terminal	0x000	◎																				

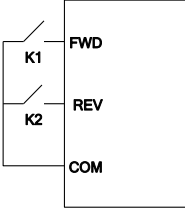
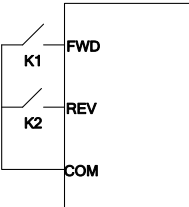
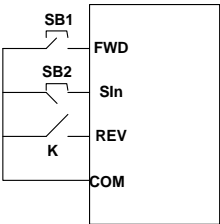
Function code	Name	Description	Default value	Modify																														
		<p>Note: After a virtual terminal is enabled, the terminal status can be changed only through communication, and the communication address is 0x200A.</p>																																
P05.13	Terminals control running mode	<p>Set the operation mode of the terminals control 0: 2-wire control 1, comply the enable with the direction. This mode is widely used. It determines the rotation direction by the defined FWD and REV terminals command.</p>  <table border="1" data-bbox="598 507 762 715"> <thead> <tr> <th>FWD</th> <th>REV</th> <th>Running command</th> </tr> </thead> <tbody> <tr> <td>OFF</td> <td>OFF</td> <td>Stopping</td> </tr> <tr> <td>ON</td> <td>OFF</td> <td>Forward running</td> </tr> <tr> <td>OFF</td> <td>ON</td> <td>Reverse running</td> </tr> <tr> <td>ON</td> <td>ON</td> <td>Hold on</td> </tr> </tbody> </table> <p>1: 2-wire control 2; Separate the enable from the direction. FWD defined by this mode is the enabling ones. The direction depends on the state of the defined REV.</p>  <table border="1" data-bbox="598 847 762 1054"> <thead> <tr> <th>FWD</th> <th>REV</th> <th>Running command</th> </tr> </thead> <tbody> <tr> <td>OFF</td> <td>OFF</td> <td>Stopping</td> </tr> <tr> <td>ON</td> <td>OFF</td> <td>Forward running</td> </tr> <tr> <td>OFF</td> <td>ON</td> <td>Stopping</td> </tr> <tr> <td>ON</td> <td>ON</td> <td>Reverse running</td> </tr> </tbody> </table> <p>2: 3-wire control 1; Sin is the enabling terminal on this mode, and the running command is caused by FWD and the direction is controlled by REV. Sin is natural closed.</p> 	FWD	REV	Running command	OFF	OFF	Stopping	ON	OFF	Forward running	OFF	ON	Reverse running	ON	ON	Hold on	FWD	REV	Running command	OFF	OFF	Stopping	ON	OFF	Forward running	OFF	ON	Stopping	ON	ON	Reverse running	0	©
FWD	REV	Running command																																
OFF	OFF	Stopping																																
ON	OFF	Forward running																																
OFF	ON	Reverse running																																
ON	ON	Hold on																																
FWD	REV	Running command																																
OFF	OFF	Stopping																																
ON	OFF	Forward running																																
OFF	ON	Stopping																																
ON	ON	Reverse running																																

Function code	Name	Description	Default value	Modify																																														
		<p>The direction control is as below during operation:</p> <table border="1"> <thead> <tr> <th>SIn</th> <th>REV</th> <th>Previous direction</th> <th>Current direction</th> </tr> </thead> <tbody> <tr> <td rowspan="2">ON</td> <td rowspan="2">OFF→ON</td> <td>Forward</td> <td>Reverse</td> </tr> <tr> <td>Reverse</td> <td>Forward</td> </tr> <tr> <td rowspan="2">ON</td> <td rowspan="2">ON→OFF</td> <td>Reverse</td> <td>Forward</td> </tr> <tr> <td>Forward</td> <td>Reverse</td> </tr> <tr> <td rowspan="2">ON→OFF</td> <td>ON</td> <td colspan="2" rowspan="2">Decelerate to stop</td> </tr> <tr> <td>OFF</td> </tr> </tbody> </table> <p>3: 3-wire control 2; SIn is the enabling terminal on this mode, and the running command is caused by SB1 or SB3 and both of them control the running direction. NC SB2 generates the stop command.</p> <table border="1"> <thead> <tr> <th>SIn</th> <th>FWD</th> <th>REV</th> <th>Direction</th> </tr> </thead> <tbody> <tr> <td rowspan="2">ON</td> <td>OFF→</td> <td>ON</td> <td>Forward</td> </tr> <tr> <td>ON</td> <td>OFF</td> <td>Reverse</td> </tr> <tr> <td rowspan="2">ON</td> <td>ON</td> <td>OFF→</td> <td>Forward</td> </tr> <tr> <td>OFF</td> <td>ON</td> <td>Reverse</td> </tr> <tr> <td>ON→</td> <td>/</td> <td>/</td> <td rowspan="2">Decelerate to stop</td> </tr> <tr> <td>OFF</td> <td>/</td> <td>/</td> </tr> </tbody> </table> <p>Note: for the 2-wire running mode, when FWD/REV terminal is valid, the VFD stop because of the stopping command from other sources, even the control terminal FWD/REV keeps valid; the VFD won't work when the stopping command is canceled. Only when FWD/REV is relaunched, the VFD can start again. For example, the valid STOP/RST stop when PLC signal cycles stop, fixed-length stop and terminal control (see P07.04).</p>	SIn	REV	Previous direction	Current direction	ON	OFF→ON	Forward	Reverse	Reverse	Forward	ON	ON→OFF	Reverse	Forward	Forward	Reverse	ON→OFF	ON	Decelerate to stop		OFF	SIn	FWD	REV	Direction	ON	OFF→	ON	Forward	ON	OFF	Reverse	ON	ON	OFF→	Forward	OFF	ON	Reverse	ON→	/	/	Decelerate to stop	OFF	/	/		
SIn	REV	Previous direction	Current direction																																															
ON	OFF→ON	Forward	Reverse																																															
		Reverse	Forward																																															
ON	ON→OFF	Reverse	Forward																																															
		Forward	Reverse																																															
ON→OFF	ON	Decelerate to stop																																																
	OFF																																																	
SIn	FWD	REV	Direction																																															
ON	OFF→	ON	Forward																																															
	ON	OFF	Reverse																																															
ON	ON	OFF→	Forward																																															
	OFF	ON	Reverse																																															
ON→	/	/	Decelerate to stop																																															
OFF	/	/																																																

Function code	Name	Description	Default value	Modify
P05.14	S1 terminal switching-on delay time	<p>The function code defines the corresponding delay time of electrical level of the programmable terminals from switching on to switching off.</p> <p>Setting range: 0.000–50.000s</p>	0.000s	○
P05.15	S1 terminal switching-off delay time		0.000s	○
P05.16	S2 terminal switching-on delay time		0.000s	○
P05.17	S2 terminal switching-off delay time		0.000s	○
P05.18	S3 terminal switching-on delay time		0.000s	○
P05.19	S3 terminal switching-off delay time		0.000s	○
P05.20	S4 terminal switching-on delay time		0.000s	○
P05.21	S4 terminal switching-off delay time		0.000s	○
P05.22	S5 terminal switching-on delay time		0.000s	○
P05.23	S5 terminal switching-off delay time		0.000s	○
P05.24	S6 terminal switching-on delay time		0.000s	○
P05.25	S6 terminal switching-off delay time		0.000s	○
P05.26	S7 terminal switching-on delay time		0.000s	○

Function code	Name	Description	Default value	Modify
P05.27	S7 terminal switching-off delay time		0.000s	<input type="radio"/>
P05.28	S8 terminal switching-on delay time		0.000s	<input type="radio"/>
P05.29	S8 terminal switching-off delay time		0.000s	<input type="radio"/>
P05.30	HDI terminal switching-on delay time		0.000s	<input type="radio"/>
P05.31	HDI terminal switching-off delay time		0.000s	<input type="radio"/>
P05.32	Lower limit of AI1		0.00V	<input type="radio"/>
P05.33	Corresponding setting of the lower limit of AI1	<p>AI1 setting is implemented through the analog potentiometer on the keypad for the 0150G/018P and lower models but is not available for the 018G/022P and higher models. AI2 setting is implemented through the control terminal AI2. AI3 setting is implemented through the control terminal AI3.</p> <p>The function code defines the relationship between the analog input voltage and its corresponding set value. If the analog input voltage beyond the set minimum or maximum input value, the VFD will count at the minimum or maximum one.</p> <p>When the analog input is the current input, the corresponding voltage of 0–20mA is 0–10V. In different cases, the corresponding rated value of 100.0% is different. See the application for detailed information.</p> <p>The figure below illustrates different applications:</p>	0.0%	<input type="radio"/>
P05.34	Upper limit of AI1		10.00V	<input type="radio"/>
P05.35	Corresponding setting of the upper limit of AI1		100.0%	<input type="radio"/>
P05.36	AI1 input filter time		0.100s	<input type="radio"/>
P05.37	Lower limit of AI2		0.00V	<input type="radio"/>
P05.38	Corresponding setting of the lower limit of AI2		0.0%	<input type="radio"/>
P05.39	Upper limit of AI2		10.00V	<input type="radio"/>
P05.40	Corresponding setting of		100.0%	<input type="radio"/>

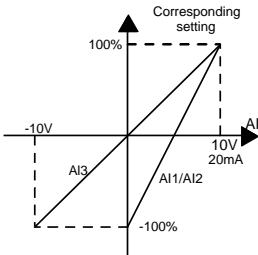
Function code	Name	Description	Default value	Modify
	the upper limit of AI2	 <p>Input filter time: this parameter is used to adjust the sensitivity of the analog input. Increasing the value properly can enhance the anti-interference of the analog, but weaken the sensitivity of the analog input</p> <p>Note: Analog AI1 and AI2 can support 0 (2)–10V or 0 (4)–20mA input, when AI1 and AI2 selects 0 (4)–20mA input, the corresponding voltage of 20mA is 10V. AI3 can support the input of -10V→+10V.</p> <p>Setting range of P05.32: 0.00V–P05.34 Setting range of P05.33: -100.0%–100.0% Setting range of P05.34: P05.32–10.00V Setting range of P05.35: -100.0%–100.0% Setting range of P05.36: 0.000s–10.000s Setting range of P05.37: 0.00V–P05.39 Setting range of P05.38: -100.0%–100.0% Setting range of P05.39: P05.37–10.00V Setting range of P05.40: -100.0%–100.0% Setting range of P05.41: 0.000s–10.000s Setting range of P05.42: -10.00V–P05.44 Setting range of P05.43: -100.0%–100.0% Setting range of P05.44: P05.42–P05.46 Setting range of P05.45: -100.0%–100.0% Setting range of P05.46: P05.44–10.00V Setting range of P05.47: -100.0%–100.0% Setting range of P05.48: 0.000s–10.000s</p>		
P05.41	AI2 input filter time		0.100s	<input type="radio"/>
P05.42	Lower limit of AI3		-10.00V	<input type="radio"/>
P05.43	Corresponding setting of the lower limit of AI3		-100.0%	<input type="radio"/>
P05.44	Middle value of AI3		0.00V	<input type="radio"/>
P05.45	Corresponding middle setting of AI3		0.0%	<input type="radio"/>
P05.46	Upper limit of AI3		10.00V	<input type="radio"/>
P05.47	Corresponding setting of the upper limit of AI3		100.0%	<input type="radio"/>
P05.48	AI3 input filter time		0.100s	<input type="radio"/>
P05.50	Lower limit frequency of HDI	0.000kHz– P05.52	0.000 kHz	<input type="radio"/>

Function code	Name	Description	Default value	Modify
P05.51	Corresponding setting of HDI low frequency setting	-100.0%–100.0%	0.0%	<input type="radio"/>
P05.52	Upper limit frequency of HDI	P05.50 –50.00kHz	50.00 kHz	<input type="radio"/>
P05.53	Corresponding setting of upper limit frequency of HDI	-100.0%–100.0%	100.0%	<input type="radio"/>
P05.54	HDI frequency input filter time	0.000s–10.000s	0.100s	<input type="radio"/>

P06 Group Output terminals

Function code	Name	Description	Default value	Modify
P06.00	HDO output	The function selection of the high-speed pulse output terminals. 0: Open collector pole high speed pulse output: The max. pulse frequency is 50.0kHz. See P06.27–P06.31 for detailed information of the related functions. 1: Open collector pole output. See P06.02 for detailed information of the related functions.	0	<input checked="" type="radio"/>
P06.01	Y1 output	0: Invalid	0	<input type="radio"/>
P06.02	HDO output	1: In operation	0	<input type="radio"/>
P06.03	Relay RO1 output	2: Forward rotation 3: Reverse rotation 4: Jogging	1	<input type="radio"/>
P06.04	Relay RO2 output	5: The VFD fault 6: Frequency degree test FDT1 7: Frequency degree test FDT2 8: Frequency arrival 9: Zero speed running (output at running state) 10: Upper limit frequency arrival 11: Lower limit frequency arrival	5	<input type="radio"/>

Function code	Name	Description	Default value	Modify								
		12: Ready for operation 13: Pre-magnetizing 14: Overload pre-alarm 15: Underload pre-alarm 16: Completion of simple PLC step 17: Completion of simple PLC cycle 18: Setting count value arrival 19: Defined count value arrival 20: External fault valid 21: Zero speed running (output at both running and stop state) 22: Running time arrival 23: MODBUS communication virtual terminals output 24: To-ground short circuit output pre-alarm (P08.23 must be set to 1.) 26: DC bus voltage establishment 27: Auxiliary motor 1 28: Auxiliary motor 2										
P06.05	Polarity selection of output terminals	The function code is used to set the pole of the output terminal. When the current bit is set to 0, output terminal is positive. When the current bit is set to 1, output terminal is negative.	0	○								
		<table border="1" style="margin-left: auto; margin-right: auto;"> <tr> <td>BIT0</td> <td>BIT1</td> <td>BIT2</td> <td>BIT3</td> </tr> <tr> <td>Y</td> <td>HDO</td> <td>RO1</td> <td>RO2</td> </tr> </table> Setting range: 0–F	BIT0	BIT1	BIT2	BIT3	Y	HDO	RO1	RO2		
BIT0	BIT1	BIT2	BIT3									
Y	HDO	RO1	RO2									
P06.06	Y1 switching-on delay time	The function code defines the corresponding delay time of the electrical level change during the programmable terminal switching on and off.	0.000s	○								
P06.07	Y1 switching-off delay time		0.000s	○								
P06.08	HDO switching-on delay time		0.000s	○								
P06.09	HDO switching-off delay time		0.000s	○								
		<p>The diagram shows a step function for 'Y electric level'. The rising edge is labeled 'Switch on delay' and the falling edge is 'Switch off delay'. The signal is 'Y valid' during the high state and 'Invalid' during the transition and low state. A shaded area indicates a period of 'Valid' during the transition.</p>										
		The setting range: 0.000–50.000s Note: P06.08 and P06.09 are valid only when P06.00=1.										

Function code	Name	Description	Default value	Modify
P06.10	RO1 switching-on delay time		0.000s	<input type="radio"/>
P06.11	RO1 switching-off delay time		0.000s	<input type="radio"/>
P06.12	RO2 switching-on delay time		0.000s	<input type="radio"/>
P06.13	RO2 switching-off delay time		0.000s	<input type="radio"/>
P06.14	AO1 output	0: Running frequency	0	<input type="radio"/>
P06.15	AO2 output	1: Setting frequency	0	<input type="radio"/>
P06.16	HDO high-speed pulse output selection	2: Ramp reference frequency 3: Running rotation speed (relative to twice the motor synchronization rotation speed) 4: Output current (relative to twice the VFD rated current) 5: Output current (relative to twice the motor rated current) 6: Output voltage (relative to 1.5 times the rated voltage of the VFD) 7: Output power (relative to twice the rated power of the motor) 9: Output torque (relative to twice the rated torque of the motor) 10: Analog AI1 input value (implemented through the analog potentiometer on the keypad for the 0150G/018P and lower models; not available for the 018G/022P and higher models.) 11: Analog AI2 input value 12: Analog AI3 input value 13: High speed pulse HDI input value 14: MODBUS communication set value 1 15: MODBUS communication set value 2 22: Torque current (relative to triple the motor rated current) 23: Ramp reference frequency(with sign)	0	<input type="radio"/>

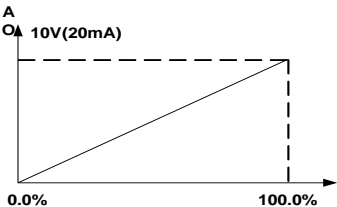
Function code	Name	Description	Default value	Modify
P06.17	Lower limit of AO1 output	<p>The above function codes define the relative relationship between the output value and analog output. When the output value exceeds the range of set maximum or minimum output, it will count according to the low-limit or upper-limit output.</p> <p>When the analog output is current output, 1mA equals to 0.5V.</p> <p>In different cases, the corresponding analog output of 100% of the output value is different. For details, see section 7.10 PID control.</p> 	0.0%	<input type="radio"/>
P06.18	Corresponding AO1 output to the lower limit		0.00V	<input type="radio"/>
P06.19	Upper limit of AO1 output		100.0%	<input type="radio"/>
P06.20	Corresponding AO1 output to the upper limit		10.00V	<input type="radio"/>
P06.21	AO1 output filter time		0.000s	<input type="radio"/>
P06.22	Lower limit of AO2 output		0.0%	<input type="radio"/>
P06.23	Corresponding AO2 output to the lower limit		0.00V	<input type="radio"/>
P06.24	Upper limit of AO2 output		100.0%	<input type="radio"/>
P06.25	Corresponding AO2 output to the upper limit		10.00V	<input type="radio"/>
P06.26	AO2 output filter time		0.000s	<input type="radio"/>
P06.27	Lower limit of HDO output		0.00%	<input type="radio"/>
P06.28	Corresponding HDO output to the lower limit		0.00 kHz	<input type="radio"/>
P06.29	Upper limit of HDO output		100.0%	<input type="radio"/>
P06.30	Corresponding HDO output to the upper limit		50.00 kHz	<input type="radio"/>
P06.31	HDO output filter time		0.000s	<input type="radio"/>

P07 Group Human-Machine Interface

Function code	Name	Description	Default value	Modify
P07.00	User's password	<p>0-65535</p> <p>The password protection will be valid when setting any non-zero number.</p> <p>00000: Clear the previous user's password, and make the password protection invalid.</p> <p>After the user's password becomes valid, if the password is incorrect, users cannot enter the parameter menu. Only correct password can make the user check or modify the parameters. Please remember all users' passwords.</p> <p>Retreat editing state of the function codes and the password protection will become valid in 1 minute.</p> <p>If the password is available, press PRG/ESC to enter into the editing state of the function codes, and then "0.0.0.0.0" will be displayed. Unless input right password, the operator cannot enter into it.</p> <p>Note: Restoring to the default value can clear the password, please use it with caution.</p>	0	○
P07.01	Parameter copy	<p>The function code determines the mode of parameters copy.</p> <p>0: No operation</p> <p>1: Upload the local function parameter to the keypad</p> <p>2: Download the keypad function parameter to local address(including the motor parameters)</p> <p>3: Download the keypad function parameter to local address (excluding the motor parameter of P02 group)</p> <p>4: Download the keypad function parameters to local address (only for the motor parameter of P02 group)</p> <p>Note: After completing the 1-4 operations, the parameter will come back to 0 automatically. The function of upload and download excludes the factory parameters of P29.</p>	0	◎
P07.02	QUICK/JOG function selection	<p>Ones: Function of QUICK/JOG key</p> <p>0: No function</p> <p>1: Jogging. Press QUICK/JOG to begin the</p>	0x01	◎

Function code	Name	Description	Default value	Modify
		<p>jogging running.</p> <p>2: Shift the display state by the shifting key. Press QUICK/JOG to shift the displayed function code from right to left.</p> <p>3: Shift between forward rotations and reverse rotations. Press QUICK/JOG to shift the direction of the frequency commands. This function is only valid in the keypad commands channels.</p> <p>4: Clear UP/DOWN settings. Press QUICK/JOG to clear the set value of UP/DOWN.</p> <p>5: Coast to stop. Press QUICK/JOG to coast to stop.</p> <p>6: Shift the running commands source. Press QUICK/JOG to shift the running commands source.</p> <p>7: Quick commission mode(committee according to the non-factory parameter)</p> <p>Note: Press QUICK/JOG to shift between forward rotation and reverse rotation, the VFD does not record the state after shifting during powering off. The VFD will run according to parameter P00.13 during next powering on.</p> <p>Tens: Keypad lock selection</p> <p>0: Do not lock keypad buttons</p> <p>1: Lock all the keypad buttons</p> <p>2: Lock part of the keypad buttons (lock PRG/ESC key only)</p> <p>Note: If the tens is 1, press PRG+DAT keys three times, and all the keypad buttons will be locked; Keep DAT key pressed down while pressing V key three times can unlock keypad buttons.</p> <p>Setting range: 0x00–0x27</p>		
P07.03	Shifting sequence selection of QUICK/JOG commands	<p>When P07.02=6, set the shifting sequence of running command channels.</p> <p>0: Keypad control→terminals control →communication control</p> <p>1: Keypad control←→terminals control</p> <p>2: Keypad control←→communication control</p> <p>3: Terminals control←→communication control</p>	0	○

Function code	Name	Description	Default value	Modify
P07.04	STOP/RST stop function	STOP/RST is valid for stop function. STOP/RST is valid in any state for the fault reset. 0: Only valid for the keypad control 1: Both valid for keypad and terminals control 2: Both valid for keypad and communication control 3: Valid for all control modes	0	○
P07.05	Parameters state 1	0x0000–0xFFFF BIT0: running frequency (Hz on) BIT1: set frequency (Hz flickering) BIT2: bus voltage (Hz on) BIT3: output voltage (V on) BIT4: output current (A on) BIT5: running rotation speed (rpm on) BIT6: output power (% on) BIT7: output torque (% on) BIT8: PID reference (% flickering) BIT9: PID feedback value (% on) BIT10: input terminals state BIT11: output terminals state BIT12: torque set value (% on) BIT13: pulse counter value BIT14: length value BIT15: PLC and the current stage in multi-step speed	0x03FF	○
P07.06	Parameters state 2	0x0000–0xFFFF BIT0: AI1 (V on) (implemented through the analog potentiometer on the keypad for the 0150G/018P and lower models; not available for the 018G/022P and higher models.) BIT1: AI2 (V on) BIT2: AI3 (V on) BIT3: HDI frequency BIT4: motor overload percentage (% on) BIT5: the VFD overload percentage (% on) BIT6: ramp frequency given value (Hz on) BIT7: linear speed BIT8: AC inlet current (A on) BIT9: upper limit frequency (Hz on)	0x0000	○

Function code	Name	Description	Default value	Modify
P07.07	The parameter in the stop state	0x0000–0xFFFF BIT0: set frequency (Hz on, frequency flickering slowly) BIT1: bus voltage (V on) BIT2: input terminals state BIT3: output terminals state BIT4: PID reference (% flickering) BIT5: PID feedback value (% flickering) BIT6: reserved BIT7: analog AI1 value (V on) (implemented through the analog potentiometer on the keypad for the 0150G/018P and lower models; not available for the 018G/022P and higher models.) BIT8: analog AI2 value (V on) BIT9: analog AI3 value (V on) BIT10: high speed pulse HDI frequency BIT11: PLC and the current step in multi-step speed BIT12: pulse counters BIT14: upper limit frequency (Hz on)	0x00FF	○
P07.08	Frequency coefficient	0.01–10.00 Displayed frequency=running frequency* P07.08	1.00	○
P07.09	Rotation speed coefficient	0.1–999.9% Mechanical rotation speed =120*displayed running frequency× P07.09 /motor pole pairs	100.0%	○
P07.10	Linear speed coefficient	0.1–999.9% Linear speed= Mechanical rotation speed× P07.10	1.0%	○
P07.11	Rectifier bridge module temperature	0–100.0°C	/	●
P07.12	IGBT module temperature	0–100.0°C	/	●
P07.13	Software version	1.00–655.35	/	●
P07.14	Local accumulative running time	0–65535h	/	●

Function code	Name	Description	Default value	Modify
P07.15	High bit of power consumption	Display the power used by the VFD. The power consumption of the VFD = $P07.15 * 1000 + P07.16$	/	●
P07.16	Low bit of power consumption	Setting range of P07.15: 0–65535 kWh (*1000) Setting range of P07.16: 0.0–999.9 kWh	/	●
P07.17	VFD type	0: G type 1: P type	/	●
P07.18	Rated power of the VFD	0.4–3000.0kW	/	●
P07.19	Rated voltage of the VFD	50–1200V	/	●
P07.20	Rated current of the VFD	0.1–6000.0A	/	●
P07.21	Factory bar code 1	0x0000–0xFFFF	/	●
P07.22	Factory bar code 2	0x0000–0xFFFF	/	●
P07.23	Factory bar code 3	0x0000–0xFFFF	/	●
P07.24	Factory bar code 4	0x0000–0xFFFF	/	●
P07.25	Factory bar code 5	0x0000–0xFFFF	/	●
P07.26	Factory bar code 6	0x0000–0xFFFF	/	●
P07.27	Type of present fault	0: No fault 1: IGBT U phase protection (OU1)	/	●
P07.28	Type of the last fault	2: IGBT V phase protection (OU2) 3: IGBT W phase protection (OU3)	/	●
P07.29	Type of the last but one fault	4: OC1 5: OC2 6: OC3	/	●
P07.30	Type of the last but two fault	7: OV1 8: OV2	/	●
P07.31	Type of the last but three fault	9: OV3 10: UV	/	●

Function code	Name	Description	Default value	Modify
P07.32	Type of the last but four fault	11: Motor overload (OL1) 12: The VFD overload (OL2) 13: Input side phase loss (SPI) 14: Output side phase loss (SPO) 15: Overheat of the rectifier module (OH1) 16: Overheat fault of the inverter module (OH2) 17: External fault (EF) 18: 485 communication fault (CE) 19: Current detection fault (ItE) 20: Motor autotune fault (tE) 21: EEPROM operation fault (EEP) 22: PID response offline fault (PIDE) 23: Braking unit fault (bCE) 24: Running time arrival (END) 25: Electrical overload (OL3) 26: Keypad communication fault (PCE) 27: Parameter uploading fault (UPE) 28: Parameter downloading fault (DNE) 32: Grounding short circuit fault 1 (ETH1) 33: Grounding short circuit fault 2 (ETH2) 36: Undervoltage fault (LL)	/	●
P07.33	Running frequency at present fault		0.00 Hz	●
P07.34	Ramp reference frequency at present fault		0.00 Hz	●
P07.35	Output voltage at the present fault		0V	●
P07.36	Output current at present fault		0.0A	●
P07.37	Bus voltage at present fault		0.0V	●
P07.38	The max. temperature at present fault		0.0°C	●
P07.39	Input terminals state at present fault		0	●
P07.40	Output terminals state at present fault		0	●
P07.41	Running frequency at the last fault		0.00 Hz	●
P07.42	Ramp reference frequency at the last fault		0.00 Hz	●
P07.43	Output voltage at the last fault		0V	●
P07.44	The output current at the last fault		0.0A	●
P07.45	Bus voltage at the last fault		0.0V	●
P07.46	The max. temperature at the last fault		0.0°C	●
P07.47	Input terminals state at the last fault		0	●
P07.48	Output terminals state at the last fault		0	●
P07.49	Running frequency at the last but one fault		0.00 Hz	●

Function code	Name	Description	Default value	Modify
P07.50	Output voltage at the last but one faults		0.00 Hz	●
P07.51	Output current at the last but one faults		0V	●
P07.52	Output current at the last but one fault		0.0A	●
P07.53	Bus voltage at the last but one fault		0.0V	●
P07.54	The max. temperature at the last but one fault		0.0°C	●
P07.55	Input terminals state at the last but one fault		0	●
P07.56	Output terminals state at the last but one fault		0	●

P08 Group Enhanced function

Function code	Name	Description	Default value	Modify
P08.00	ACC time 2	Refer to P00.11 and P00.12 for detailed definition. Goodrive200A series define four groups of ACC/DEC time which can be selected by P5 group. The first group of ACC/DEC time is the factory default one. Setting range: 0.0–3600.0s	Model depended	<input type="radio"/>
P08.01	DEC time 2		Model depended	<input type="radio"/>
P08.02	ACC time 3		Model depended	<input type="radio"/>
P08.03	DEC time 3		Model depended	<input type="radio"/>
P08.04	ACC time 4		Model depended	<input type="radio"/>
P08.05	DEC time 4		Model depended	<input type="radio"/>
P08.06	Jogging frequency	This parameter is used to define the reference frequency during jogging. Setting range: 0.00Hz –P00.03 (the max. frequency)	5.00 Hz	<input type="radio"/>
P08.07	Jogging ACC time	The jogging ACC time means the time needed if the VFD runs from 0Hz to the max. frequency.	Model depended	<input type="radio"/>
P08.08	Jogging DEC time	The jogging DEC time means the time needed if the VFD goes from the max. frequency (P00.03) to 0Hz. Setting range: 0.0–3600.0s	Model depended	<input type="radio"/>
P08.09	Jumping frequency 1	When the set frequency is in the range of jumping frequency, the VFD will run at the edge of the jumping frequency.	0.00 Hz	<input type="radio"/>
P08.10	Jumping frequency range 1	The VFD can avoid the mechanical resonance point by setting the jumping frequency. The VFD	0.00 Hz	<input type="radio"/>

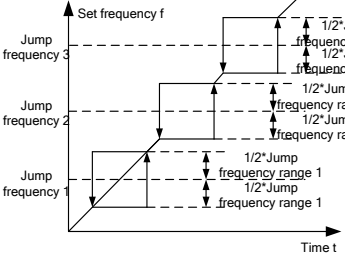
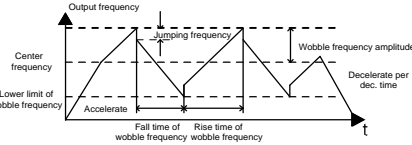
Function code	Name	Description	Default value	Modify
P08.11	Jumping frequency 2	 <p>can set three jumping frequency. But this function will be invalid if all jumping points are 0.</p>	0.00 Hz	<input type="radio"/>
P08.12	Jumping frequency range 2		0.00 Hz	<input type="radio"/>
P08.13	Jumping frequency 3		0.00 Hz	<input type="radio"/>
P08.14	Jumping frequency range 3		Setting range: 0.00Hz –P00.03 (the max. frequency)	0.00 Hz
P08.15	Traverse range	<p>This function applies to the industries where traverse and convolution function are required such as textile and chemical fiber.</p> <p>The traverse function means that the output frequency of the VFD is fluctuated with the set frequency as its center. The route of the running frequency is illustrated as below, of which the traverse is set by P08.15 and when P08.15 is set as 0, the traverse is 0 with no function.</p> 	0.0%	<input type="radio"/>
P08.16	Sudden jumping frequency range		0.0%	<input type="radio"/>
P08.17	Traverse boost time		5.0s	<input type="radio"/>
P08.18	Traverse declining time	<p>Traverse range: The traverse running is limited by upper and low frequency.</p> <p>The traverse range relative to the center frequency: traverse range AW = center frequency x traverse range P08.15.</p> <p>Sudden jumping frequency = traverse range AW x sudden jumping frequency range P08.16.</p> <p>When run at the traverse frequency, the value which is relative to the sudden jumping frequency.</p> <p>The raising time of the traverse frequency: The time from the lowest point to the highest one.</p>	5.0s	<input type="radio"/>

Function code	Name	Description	Default value	Modify
		The declining time of the traverse frequency: The time from the highest point to the lowest one. Setting range of P08.15: 0.0–100.0% (relative to the set frequency) Setting range of P08.16: 0.0–50.0% (relative to the traverse range) Setting range of P08.17: 0.1–3600.0s Setting range of P08.18: 0.1–3600.0s		
P08.19	Number of the displayed decimal points	Ones: Number of decimal points of linear speed 0: No decimal point 1: One decimal point 2: Two decimal points 3: Three decimal points Tens: Number of decimal points of frequency 0: Two decimal points 1: One decimal point Range: 0x00–0x13	0x00	○
P08.20	Correcting analog input and output	0: Correct 1: Not correct Setting range: 0–1	0	◎
P08.22	Sleep delay	0.0–3600.0s Valid for P01.19 selected as 2, the delay time to enter hibernation.	2.0s	○
P08.23	To-ground short circuit detection during running	0: Disable 1: Enable	0	○
P08.24	Power-on to-ground short circuit detection threshold	0%–100%	50%	○
P08.25	Setting counting value	The counter counts the input pulse signals through the S terminals (with the counter triggering function) or HDI (P05.00=1).	0	○
P08.26	Reference counting value		0	○

Function code	Name	Description	Default value	Modify
		<p>signal of "fixed counting number arrival" and the counter go on working; when the counter achieves a setting number, the multi-function output terminals will output the signal of "setting counting number arrival", the counter will clear all numbers and stop to recount before the next pulse.</p> <p>The setting counting value P08.26 should be no more than the setting counting value P08.25.</p> <p>The function is illustrated as below:</p> <p>Setting range of P08.25: P08.26–65535 Setting range of P08.26: 0–P08.25</p>		
P08.27	Set running time	<p>Pre-set running time of the VFD. When the accumulative running time achieves the set time, the multi-function digital output terminals will output the signal of "running time arrival".</p> <p>Setting range: 0–65535 min</p>	0m	○
P08.28	Fault reset times	<p>The time of the fault reset: set the fault reset time by selecting this function. If the reset time exceeds this set value, the VFD will stop for the fault and wait to be repaired.</p>	0	○
P08.29	Interval time of automatic fault reset	<p>The interval time of the fault reset: The interval between the time when the fault occurs and the time when the reset action occurs.</p> <p>Setting range of P08.28: 0–10 Setting range of P08.29: 0.1–3600.0s</p>	1.0s	○
P08.30	Frequency decreasing ratio of the dropping control	<p>The output frequency of the VFD changes as the load. And it is mainly used to balance the power when several VFDs drive one load.</p> <p>Setting range: 0.00–10.00Hz</p>	0.00 Hz	○
P08.32	FDT1 electrical level detection value	<p>When the output frequency exceeds the corresponding frequency of FDT electrical level, the multi-function digital output terminals will</p>	50.00 Hz	○
P08.33	FDT1 retention detection value	<p>output the signal of "frequency level detect FDT" until the output frequency decreases to a value</p>	5.0%	○

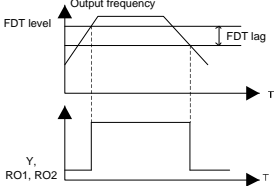
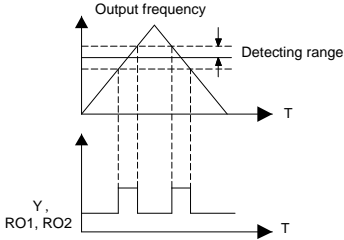
Function code	Name	Description	Default value	Modify
P08.34	FDT2 electrical level detection value	lower than (FDT electrical level—FDT retention detection value) the corresponding frequency, the signal is invalid. Below is the waveform diagram:	50.00 Hz	○
P08.35	FDT2 retention detection value	 <p>Setting range of P08.32: 0.00Hz–P00.03 (the max. frequency) Setting range of P08.33: 0–100.0% (FDT1 electrical level) Setting range of P08.34: 0.00 Hz –P00.03 (the max. frequency) Setting range of P08.35: 0.0–100.0% (FDT2 electrical level)</p>	5.0%	○
P08.36	Amplitude value for frequency arrival detection	<p>When the output frequency is among the below or above range of the set frequency, the multi-function digital output terminal will output the signal of "frequency arrival", see the diagram below for detailed information:</p>  <p>The setting range: 0.00Hz–P00.03 (the max. frequency)</p>	0.00 Hz	○
P08.37	Energy braking enable	<p>This parameter is used to control the internal braking unit.</p> <p>0: Disable 1: Enable</p> <p>Note: Only applicable to the models with internal braking units.</p>	0	○

Function code	Name	Description	Default value	Modify
P08.38	Threshold voltage	After setting the original bus voltage, adjust this parameter to break the load appropriately. The factory value changes with voltage level. Setting range: 200.0–2000.0V	For 220V: 380.0V	○
			For 380V: 700.0V	
			For 660V: 1120.0V	
P08.39	Cooling fan running mode	Set the operation mode of the cooling fan. 0: Normal mode, after the rectifier receives operation command or the detected temperature of module is above 45°C or the module current is above 20% of the rated current, the fan rotates. 1: The fan keeps on running after power on (generally for the site with high temperature and humidity) 2: The fan will start when the ramp frequency of the VFD is larger than 0Hz; if the running frequency is 0Hz or changes from running state to stop state, the fan will stop after one minute. Setting range: 0–2	0	○
P08.40	PWM selection	0x00–0x21 LED ones: PWM mode selection 0: PWM mode 1, three-phase modulation and two-modulation 1: PWM mode 2, three-phase modulation LED tens: low-speed carrier frequency limit mode 0: Low-speed carrier frequency limit mode 1, the carrier frequency will limit to 2k if it exceeds 2k at low speed 1: Low-speed carrier frequency limit mode 2, the carrier frequency will limit to 4k if it exceeds 4k at low speed 2: No limit	00	◎
P08.41	Over modulation selection	0x00–0x11 LED ones 0: Invalid 1: Valid LED tens 0: Light overmodulation 1: Heavy overmodulation	0x01	◎

Function code	Name	Description	Default value	Modify
P08.42	Keypad data control	<p>0x000–0x1223</p> <p>LED ones: frequency enable selection</p> <p>0: Both \wedge/\vee keys and digital potentiometer adjustments are valid</p> <p>1: Only \wedge/\vee keys adjustment is valid</p> <p>2: Only digital potentiometer adjustments is valid</p> <p>3: Neither \wedge/\vee keys nor digital potentiometer adjustments are valid</p> <p>LED tens: frequency control selection</p> <p>0: Only valid when $P00.06=0$ or $P00.07=0$</p> <p>1: Valid for all frequency setting manner</p> <p>2: Invalid for multi-step speed when multi-step speed has the priority</p> <p>LED hundreds: action selection during stopping</p> <p>0: Setting is valid</p> <p>1: Valid during running, cleared after stopping</p> <p>2: Valid during running, cleared after receiving the stop command</p> <p>LED thousands: \wedge/\vee keys and digital potentiometer integral function</p> <p>0: The integral function is valid</p> <p>1: The integral function is invalid</p>	0x0000	○
P08.43	Integral ratio of the keypad potentiometer	0.01–10.00s	0.10s	○
P08.44	UP/DOWN terminals control	<p>0x00–0x221</p> <p>LED ones: frequency control selection</p> <p>0: UP/DOWN terminals setting valid</p> <p>1: UP/DOWN terminals setting valid</p> <p>LED tens: frequency control selection</p> <p>0: Only valid when $P00.06=0$ or $P00.07=0$</p> <p>1: All frequency means are valid</p> <p>2: When the multi-step are priority, it is invalid to the multi-step</p> <p>LED hundreds: action selection when stop</p> <p>0: Setting valid</p> <p>1: Valid in the running, clear after stop</p> <p>2: Valid in the running, clear after receiving the stop commands</p>	0x000	○

Function code	Name	Description	Default value	Modify
P08.45	UP terminals frequency incremental change rate	0.01–50.00Hz/s	0.50 Hz/s	<input type="radio"/>
P08.46	DOWN terminals frequency incremental change rate	0.01–50.00 Hz/s	0.50 Hz/s	<input type="radio"/>
P08.47	Action when the frequency setting is off	0x000–0x111 LED ones: Action selection when power off. 0: Save when power off 1: Clear when power off LED tens: Action selection when MODBUS set frequency off 0: Save when power off 1: Clear when power off LED hundreds: The action selection when other frequency set frequency off 0: Save when power off 1: Clear when power off	0x000	<input type="radio"/>
P08.48	High bit of initial power consumption	This parameter is used to set the original value of the power consumption. The original value of the power consumption	0	<input type="radio"/>
P08.49	Low bit of initial power consumption	=P08.48*1000+ P08.49(kWh) Setting range of P08.48: 0–59999 Setting range of P08.49: 0.0–999.9	0.0	<input type="radio"/>
P08.50	Magnetic flux braking	This function code is used to enable magnetic flux. 0: Invalid. 100–150: The bigger the coefficient, the stronger the braking is. This VFD is used to increase the magnetic flux to decelerate the motor. The energy generated by the motor during braking can be converted into heat energy by increasing the magnetic flux. The VFD monitors the state of the motor continuously even during the magnetic flux period. So the magnetic flux can be used in the motor	0	<input checked="" type="radio"/>

Function code	Name	Description	Default value	Modify
		stop, as well as to change the rotation speed of the motor. Its other advantages are: Brake immediately after the stop command. It does not need to wait the magnetic flux weaken. Better cooling for motors. The current of the stator other than the rotor increases during magnetic flux braking, while the cooling of the stator is more effective than the rotor.		
P08.51	Current regulation coefficient on input side	This function code is used to adjust the displayed current of the AC input side. Setting range: 0.00–1.00	0.56	<input type="radio"/>

P09 Group PID control

Function code	Name	Description	Default value	Modify
P09.00	PID reference source	When the frequency command selection (P00.06 , P00.07) is 7 or the voltage setting channel selection (P04.27) is 6, the running mode of the VFD is procedure PID controlled. The parameter determines the target reference channel during the PID procures. 0: Set by P09.01 1: Analog channel AI1 reference (implemented through the analog potentiometer on the keypad for the 0150G/018P and lower models; not available for the 018G/022P and higher models.) 2: Analog channel AI2 reference 3: Analog channel AI3 set 4: High speed pulse HDI set 5: Multi-step speed set 6: MODBUS communication set The setting target of procedure PID is a relative one, 100% of the setting equals to 100% of the response of the controlled system. The system is calculated according to the relative value (0–100.0%). Note: Multi-step speed reference, it is realized by setting P10 group parameters.	0	<input type="radio"/>

Function code	Name	Description	Default value	Modify
P09.01	PID value reference	When P09.00=0, set the parameter whose basic value is the feedback value of the system. The setting range: -100.0%~100.0%	0.0%	<input type="radio"/>
P09.02	PID feedback source	Select the PID channel by the parameter. 0: Analog channel AI1 feedback (implemented through the analog potentiometer on the keypad for the 0150G/018P and lower models; not available for the 018G/022P and higher models.) 1: Analog channel AI2 feedback 2: Analog channel AI3 feedback 3: High speed HDI feedback 4: MODBUS communication feedback 5: MAX(AI2,AI3) Note: The reference channel and the feedback channel cannot coincide, otherwise, PID cannot control effectively.	0	<input type="radio"/>
P09.03	PID output feature	0: PID output is positive: When the feedback signal exceeds the PID reference value, the output frequency of the VFD will decrease to balance the PID. For example, the strain PID control during wrap-up 1: PID output is negative: When the feedback signal is stronger than the PID reference value, the output frequency of the VFD will increase to balance the PID. For example, the strain PID control during wrap-down	0	<input type="radio"/>
P09.04	Proportional gain (Kp)	The function is applied to the proportional gain P of PID input. P determines the strength of the whole PID adjuster. The parameter of 100 means that when the offset of PID feedback and reference value is 100%, the adjusting range of PID adjuster is the max. frequency (ignoring integral function and differential function). The setting range: 0.00~100.00	1.00	<input type="radio"/>
P09.05	Integral time (Ti)	This parameter determines the speed of PID adjuster to carry out integral adjustment on the deviation of PID feedback and reference. When the deviation of PID feedback and reference is 100%, the integral adjuster works	0.00s	<input type="radio"/>

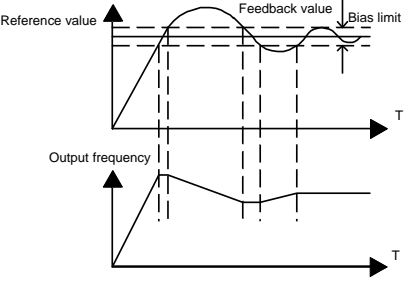
Function code	Name	Description	Default value	Modify
		continuously after the time (ignoring the proportional effect and differential effect) to achieve the max. frequency (P00.03) or the max. voltage (P04.31). Shorter the integral time, stronger is the adjustment Setting range: 0.00–10.00s		
P09.06	Differential time (Td)	This parameter determines the strength of the change ratio when PID adjustor carries out integral adjustment on the deviation of PID feedback and reference. If the PID feedback changes 100% during the time, the adjustment of integral adjustor (ignoring the proportional effect and differential effect) is the max. frequency (P00.03) or the max. voltage (P04.31). Longer the integral time, stronger is the adjusting. Setting range: 0.00–10.00s	0.00s	○
P09.07	Sampling cycle (T)	This parameter means the sampling cycle of the feedback. The modulator calculates in each sampling cycle. The longer the sampling cycle is, the slower the response is. Setting range: 0.000–10.000s	0.100s	○
P09.08	PID control deviation limit	The output of PID system is relative to the maximum deviation of the close loop reference. As shown in the diagram below, PID adjustor stops to work during the deviation limit. Set the function properly to adjust the accuracy and stability of the system.  Setting range: 0.0–100.0%	0.0%	○
P09.09	Output upper limit of PID	These parameters are used to set the upper and lower limit of the PID adjustor output.	100.0%	○

Function code	Name	Description	Default value	Modify
P09.10	Output lower limit of PID	100.0 % corresponds to max. frequency or the max. voltage of (P04.31) Setting range of P09.09: P09.10–100.0% Setting range of P09.10: -100.0%–P09.09	0.0%	○
P09.11	Feedback offline detection value	Set the PID feedback offline detection value, when the detection value is smaller than or equal to the feedback offline detection value, and the lasting time exceeds the set value in P09.12, the VFD will report "PID feedback offline fault" and the keypad will display PIDE.	0.0%	○
P09.12	Feedback offline detection time	<p>Setting range of P09.11: 0.0–100.0% Setting range of P09.12: 0.0–3600.0s</p>	1.0s	○
P09.13	PID adjustment	0x0000–0x1111 LED ones: 0: Keep on integral adjustment when the frequency achieves the upper and low limit; the integration shows the change between the reference and the feedback unless it reaches the internal integral limit. When the trend between the reference and the feedback changes, it needs more time to offset the impact of continuous working and the integration will change with the trend. 1: Stop integral adjustment when the frequency achieves the upper and low limit. If the integration keeps stable, and the trend between the reference and the feedback changes, the integration will change with the trend quickly. LED tens: P00.08 is 0 0: The same with the setting direction; if the output of PID adjustment is different from the current	0x0001	○

Function code	Name	Description	Default value	Modify
		running direction, the internal will output 0 forcedly. 1: Opposite to the setting direction LED hundreds: P00.08 is 0 0: Limit to the maximum frequency 1: Limit to frequency A LED thousands: 0: A+B frequency, the buffer of A frequency is invalid 1: A+B frequency, the buffer of A frequency is valid ACC/DEC is determined by ACC time 4 of P08.04 .		
P09.14	Proportional gain at low frequency (Kp)	0.00–100.00	1.00	<input type="radio"/>
P09.15	PID command of ACC/DEC time	0.0–1000.0s	0.0s	<input type="radio"/>
P09.16	PID output filter time	0.000–10.000s	0.000s	<input type="radio"/>

P10 Group Simple PLC and multi-step speed control

Function code	Name	Description	Default value	Modify
P10.00	Simple PLC	0: Stop after running once. The VFD has to be commanded again after finishing a cycle. 1: Run at the final value after running once. After finish a signal, the VFD will keep the running frequency and direction of the last run. 2: Cycle running. The VFD will keep on running until receiving a stop command and then, the system will stop.	0	<input type="radio"/>
P10.01	Simple PLC memory	0: Power loss without memory 1: Power loss memory; PLC record the running step and frequency when power loss.	0	<input type="radio"/>
P10.02	Multi-step speed 0	100.0% of the frequency setting corresponds to the max. frequency P00.03.	0.0%	<input type="radio"/>

Function code	Name	Description	Default value	Modify
P10.03	Running time of step 0	<p>When selecting simple PLC running, set P10.02–P10.33 to define the running frequency and direction of all steps.</p> <p>Note: The symbol of multi-step determines the running direction of simple PLC. The negative value means reverse rotation.</p>	0.0s	<input type="radio"/>
P10.04	Multi-step speed 1		0.0%	<input type="radio"/>
P10.05	Running time of step 1		0.0s	<input type="radio"/>
P10.06	Multi-step speed 2		0.0%	<input type="radio"/>
P10.07	Running time of step 2		0.0s	<input type="radio"/>
P10.08	Multi-step speed 3		0.0%	<input type="radio"/>
P10.09	Running time of step 3		0.0s	<input type="radio"/>
P10.10	Multi-step speed 4		0.0%	<input type="radio"/>
P10.11	Running time of step 4		0.0s	<input type="radio"/>
P10.12	Multi-step speed 5		0.0%	<input type="radio"/>
P10.13	Running time of step 5	<p>Multi-step speeds are in the range of $-f_{max}-f_{max}$ and it can be set continuously.</p> <p>Goodrive200A series VFDs can set 16 steps speed, selected by the combination of multi-step terminals 1–4, corresponding to the speed 0 to speed 15.</p>	0.0s	<input type="radio"/>
P10.14	Multi-step speed 6		0.0%	<input type="radio"/>
P10.15	Running time of step 6		0.0s	<input type="radio"/>
P10.16	Multi-step speed 7		0.0%	<input type="radio"/>
P10.17	Running time of step 7		0.0s	<input type="radio"/>
P10.18	Multi-step speed 8		0.0%	<input type="radio"/>
P10.19	Running time of step 8		0.0s	<input type="radio"/>
P10.20	Multi-step speed 9		0.0%	<input type="radio"/>
P10.21	Running time of step 9		0.0s	<input type="radio"/>
P10.22	Multi-step speed 10		0.0%	<input type="radio"/>

Function code	Name	Description	Default value	Modify																																																																																																																									
P10.23	Running time of step 10	1, terminal 2, terminal 3, and terminal 4. The start and stopping of multi-step running is determined by function code P00.06, the relationship between terminal 1 (16), terminal 2 (17), terminal 3 (18), terminal 4 (19) and multi-step speed is as following: <table border="1" style="font-size: small;"> <tr><td>Terminal 1</td><td>OFF</td><td>ON</td><td>OFF</td><td>ON</td><td>OFF</td><td>ON</td><td>OFF</td><td>ON</td></tr> <tr><td>Terminal 2</td><td>OFF</td><td>OFF</td><td>ON</td><td>ON</td><td>OFF</td><td>OFF</td><td>ON</td><td>ON</td></tr> <tr><td>Terminal 3</td><td>OFF</td><td>OFF</td><td>OFF</td><td>OFF</td><td>ON</td><td>ON</td><td>ON</td><td>ON</td></tr> <tr><td>Terminal 4</td><td>OFF</td><td>OFF</td><td>OFF</td><td>OFF</td><td>OFF</td><td>OFF</td><td>OFF</td><td>OFF</td></tr> <tr><td>Step</td><td>0</td><td>1</td><td>2</td><td>3</td><td>4</td><td>5</td><td>6</td><td>7</td></tr> </table>	Terminal 1	OFF	ON	OFF	ON	OFF	ON	OFF	ON	Terminal 2	OFF	OFF	ON	ON	OFF	OFF	ON	ON	Terminal 3	OFF	OFF	OFF	OFF	ON	ON	ON	ON	Terminal 4	OFF	OFF	OFF	OFF	OFF	OFF	OFF	OFF	Step	0	1	2	3	4	5	6	7	0.0s	○																																																																												
Terminal 1	OFF		ON	OFF	ON	OFF	ON	OFF	ON																																																																																																																				
Terminal 2	OFF		OFF	ON	ON	OFF	OFF	ON	ON																																																																																																																				
Terminal 3	OFF		OFF	OFF	OFF	ON	ON	ON	ON																																																																																																																				
Terminal 4	OFF		OFF	OFF	OFF	OFF	OFF	OFF	OFF																																																																																																																				
Step	0		1	2	3	4	5	6	7																																																																																																																				
P10.24	Multi-step speed 11		0.0%	○																																																																																																																									
P10.25	Running time of step 11		0.0s	○																																																																																																																									
P10.26	Multi-step speed 12		0.0%	○																																																																																																																									
P10.27	Running time of step 12		0.0s	○																																																																																																																									
P10.28	Multi-step speed 13		0.0%	○																																																																																																																									
P10.29	Running time of step 13		0.0s	○																																																																																																																									
P10.30	Multi-step speed 14		0.0%	○																																																																																																																									
P10.31	Running time of step 14		0.0s	○																																																																																																																									
P10.32	Multi-step speed 15		Setting range of P10.(2n,1<n<17): -100.0~100.0% Setting range of P10.(2n+1,1<n<17): 0.0~6553.5s(min)	0.0%	○																																																																																																																								
P10.33	Running time of step 15	0.0s	○																																																																																																																										
P10.34	Simple PLC 0~7 step ACC/DEC time	Below is the detailed instruction: <table border="1" style="font-size: small;"> <thead> <tr> <th>Function code</th> <th>Binary bit</th> <th>Step</th> <th>ACC/DEC 0</th> <th>ACC/DEC 1</th> <th>ACC/DEC 2</th> <th>ACC/DEC 3</th> </tr> </thead> <tbody> <tr><td rowspan="8">P10.34</td><td>BIT1</td><td>BIT0</td><td>0</td><td>00</td><td>01</td><td>10</td><td>11</td></tr> <tr><td>BIT3</td><td>BIT2</td><td>1</td><td>00</td><td>01</td><td>10</td><td>11</td></tr> <tr><td>BIT5</td><td>BIT4</td><td>2</td><td>00</td><td>01</td><td>10</td><td>11</td></tr> <tr><td>BIT7</td><td>BIT6</td><td>3</td><td>00</td><td>01</td><td>10</td><td>11</td></tr> <tr><td>BIT9</td><td>BIT8</td><td>4</td><td>00</td><td>01</td><td>10</td><td>11</td></tr> <tr><td>BIT11</td><td>BIT10</td><td>5</td><td>00</td><td>01</td><td>10</td><td>11</td></tr> <tr><td>BIT13</td><td>BIT12</td><td>6</td><td>00</td><td>01</td><td>10</td><td>11</td></tr> <tr><td>BIT15</td><td>BIT14</td><td>7</td><td>00</td><td>01</td><td>10</td><td>11</td></tr> <tr><td rowspan="8">P10.35</td><td>BIT1</td><td>BIT0</td><td>8</td><td>00</td><td>01</td><td>10</td><td>11</td></tr> <tr><td>BIT3</td><td>BIT2</td><td>9</td><td>00</td><td>01</td><td>10</td><td>11</td></tr> <tr><td>BIT5</td><td>BIT4</td><td>10</td><td>00</td><td>01</td><td>10</td><td>11</td></tr> <tr><td>BIT7</td><td>BIT6</td><td>11</td><td>00</td><td>01</td><td>10</td><td>11</td></tr> <tr><td>BIT9</td><td>BIT8</td><td>12</td><td>00</td><td>01</td><td>10</td><td>11</td></tr> <tr><td>BIT11</td><td>BIT10</td><td>13</td><td>00</td><td>01</td><td>10</td><td>11</td></tr> <tr><td>BIT13</td><td>BIT12</td><td>14</td><td>00</td><td>01</td><td>10</td><td>11</td></tr> <tr><td>BIT15</td><td>BIT14</td><td>15</td><td>00</td><td>01</td><td>10</td><td>11</td></tr> </tbody> </table>	Function code	Binary bit	Step	ACC/DEC 0	ACC/DEC 1	ACC/DEC 2	ACC/DEC 3	P10.34	BIT1	BIT0	0	00	01	10	11	BIT3	BIT2	1	00	01	10	11	BIT5	BIT4	2	00	01	10	11	BIT7	BIT6	3	00	01	10	11	BIT9	BIT8	4	00	01	10	11	BIT11	BIT10	5	00	01	10	11	BIT13	BIT12	6	00	01	10	11	BIT15	BIT14	7	00	01	10	11	P10.35	BIT1	BIT0	8	00	01	10	11	BIT3	BIT2	9	00	01	10	11	BIT5	BIT4	10	00	01	10	11	BIT7	BIT6	11	00	01	10	11	BIT9	BIT8	12	00	01	10	11	BIT11	BIT10	13	00	01	10	11	BIT13	BIT12	14	00	01	10	11	BIT15	BIT14	15	00	01	10	11	0x0000	○
Function code	Binary bit	Step	ACC/DEC 0	ACC/DEC 1	ACC/DEC 2	ACC/DEC 3																																																																																																																							
P10.34	BIT1	BIT0	0	00	01	10	11																																																																																																																						
	BIT3	BIT2	1	00	01	10	11																																																																																																																						
	BIT5	BIT4	2	00	01	10	11																																																																																																																						
	BIT7	BIT6	3	00	01	10	11																																																																																																																						
	BIT9	BIT8	4	00	01	10	11																																																																																																																						
	BIT11	BIT10	5	00	01	10	11																																																																																																																						
	BIT13	BIT12	6	00	01	10	11																																																																																																																						
	BIT15	BIT14	7	00	01	10	11																																																																																																																						
P10.35	BIT1	BIT0	8	00	01	10	11																																																																																																																						
	BIT3	BIT2	9	00	01	10	11																																																																																																																						
	BIT5	BIT4	10	00	01	10	11																																																																																																																						
	BIT7	BIT6	11	00	01	10	11																																																																																																																						
	BIT9	BIT8	12	00	01	10	11																																																																																																																						
	BIT11	BIT10	13	00	01	10	11																																																																																																																						
	BIT13	BIT12	14	00	01	10	11																																																																																																																						
	BIT15	BIT14	15	00	01	10	11																																																																																																																						
P10.35	Simple PLC 8~15 step ACC/DEC time		0x0000	○																																																																																																																									

Function code	Name	Description	Default value	Modify
		After the users select the corresponding ACC/DEC time, the combined 16 binary bits will change into decimal bit, and then set the corresponding function codes. Setting range: 0x0000–0xFFFF		
P10.36	PLC restart	0: Restart from the first step; stop during running (cause by the stop command, fault or power loss), run from the first step after restart. 1: Continue to run from the stop frequency; stop during running (cause by stop command and fault), the VFD will record the running time automatically, enter into the step after restart and keep the remaining running at the setting frequency.	0	☉
P10.37	Multi-step time unit	0: Seconds; the running time of all steps is counted by second 1: Minutes; the running time of all steps is counted by minute	0	☉

P11 Group Protective parameters

Function code	Name	Description	Default value	Modify
P11.00	Phase loss protection	0x00–0x11 LED ones: 0: Input phase loss protection disable 1: Input phase loss protection enable LED tens: 0: Output phase loss protection disable 1: Output phase loss protection enable LED hundreds: 0: Input phase loss hardware protection disable 1: Input phase loss hardware protection enable	111	○
P11.01	Sudden power loss frequency decrease	0: Disable 1: Enable	0	○
P11.02	Frequency decrease ratio of sudden power loss	Setting range: 0.00Hz/s–P00.03 (max. frequency) After the power loss of the grid, the bus voltage drops to the sudden frequency-decreasing point, the VFD begin to decrease the running frequency	10.00 Hz/s	○

Function code	Name	Description	Default value	Modify								
		<p>at P11.02, to make the VFD generate power again. The returning power can maintain the bus voltage to ensure a rated running of the VFD until power recovery.</p> <table border="1"> <thead> <tr> <th>Voltage degree</th> <th>220V</th> <th>380V</th> <th>660V</th> </tr> </thead> <tbody> <tr> <td>Frequency decrease point at sudden power loss</td> <td>260V</td> <td>460V</td> <td>800V</td> </tr> </tbody> </table> <p>Note:</p> <ol style="list-style-type: none"> 1. Adjust the parameter properly to avoid the stopping caused by VFD protection during the switching of the grid. 2. Disable input phase loss protection to enable this function. 	Voltage degree	220V	380V	660V	Frequency decrease point at sudden power loss	260V	460V	800V		
Voltage degree	220V	380V	660V									
Frequency decrease point at sudden power loss	260V	460V	800V									
P11.03	Overvoltage stall protection	<p>0: Disable 1: Enable</p>	1	○								
P11.04	Protection voltage at overvoltage stall	120–150%(standard bus voltage) (380V)	136%	○								
		120–150%(standard bus voltage) (220V)	120%									
P11.05	Current limit action selection	<p>The actual increasing ratio is less than the ratio of output frequency because of the big load during ACC running. It is necessary to take measures to avoid overcurrent fault and the VFD trips. During the running of the VFD, this function will detect the output current and compare it with the limit defined in P11.06. If it exceeds the level, the VFD will run at stable frequency in ACC running, or the VFD will derate to run during the constant running. If it exceeds the level continuously, the output frequency will keep on decreasing to the lower limit. If the output current is detected to be lower than the limit level, the VFD will accelerate to run.</p>	01	◎								
P11.06	Automatic current limit		G type:	◎								
			P type:									
P11.07	The decreasing ratio during current limit		10.00 Hz/s	◎								

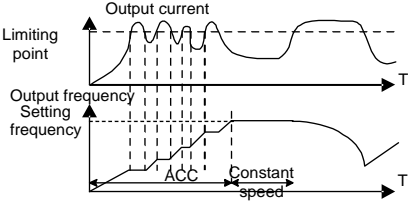
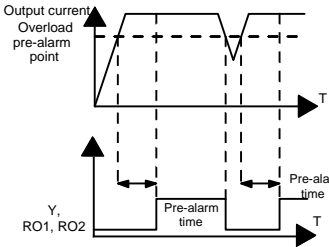
Function code	Name	Description	Default value	Modify
		 <p>Setting range of P11.05: 0x00–0x11 LED ones: current limit 0: Invalid 1: Always valid LED tens: overload alarm 0: Valid 1: Invalid Setting range of P11.06: 50.0–200.0% (corresponding to the rated output current of the VFD) Setting range of P11.07: 0.00–50.00Hz/s</p>		
P11.08	Overload pre-alarm of the motor/VFD	The output current of the VFD or the motor is above P11.09 and the lasting time is beyond P11.10 , overload pre-alarm will be output.	0x000	○
P11.09	Overload pre-alarm test level		G type: 150% P type: 120%	○
P11.10	Overload pre-alarm detection time	<p>Setting range of P11.08: Enable and define the overload pre-alarm of the VFD or the motor. LED ones: 0: Overload pre-alarm of the motor, comply with the rated current of the motor 1: Overload pre-alarm of the VFD, comply with the rated output current of the VFD</p>	0x0000	○

Function code	Name	Description	Default value	Modify
		<p>2: VFD output torque overload/underload pre-alarm, corresponding to the rated motor torque</p> <p>LED tens:</p> <p>0: The VFD continues to work after underload pre-alarm</p> <p>1: The VFD continues to work after underload pre-alarm and the VFD stops running after overload fault</p> <p>2: The VFD continues to work after overload pre-alarm and the VFD stops running after underload fault</p> <p>3. The VFD stops when overload or underload.</p> <p>LED hundreds :</p> <p>0: Detection all the time</p> <p>1: Detection in constant running</p> <p>LED thousands: Overload integral selection</p> <p>0: Overload integral is invalid</p> <p>1: Overload integral is valid</p> <p>Setting range of P11.08: 0000–1131</p> <p>Setting range of P11.09: P11.11–200% (relative value determined by the ones place of P11.08)</p> <p>Setting range of P11.10: 0.1–3600.0s</p>		
P11.11	Detection level of underload pre-alarm	If the VFD current or the output current is lower than P11.11 , and its lasting time is beyond P11.12 , the VFD will output underload pre-alarm.	50%	<input type="radio"/>
P11.12	Detection time of underload pre-alarm	Setting range of P11.11 : 0– P11.09 (relative value determined by the ones place of P11.08) Setting range of P11.12 : 0.1–3600.0s	1.0s	<input type="radio"/>
P11.13	Output terminal action during fault	<p>Select the action of fault output terminals on undervoltage and fault reset.</p> <p>0x00–0x11</p> <p>LED ones:</p> <p>0: Action under fault undervoltage</p> <p>1: No action under fault undervoltage</p> <p>LED tens:</p> <p>0: Action during the automatic reset</p> <p>1: No action during the automatic reset</p>	0x00	<input type="radio"/>

Function code	Name	Description	Default value	Modify
P11.16	Extension functions selection	0x00–0x11 LED ones: Voltage drop frequency-decreasing selection 0: Voltage drop frequency-decreasing selection disable 1: Voltage drop frequency-decreasing selection enable LED tens: Step 2 ACC/DEC time option 0: Step 2 ACC/DEC time option disable 1: Step 2 ACC/DEC time option enable, when running frequency more than P08.36, ACC/DEC time switch to step 2 ACC/DEC time	00	<input type="radio"/>

P13 Group Enhanced function parameters

Function code	Name	Description	Default value	Modify
P13.13	Braking current of short-circuit	When P01.00=0 during the starting of the VFD, set P13.14 to a non-zero value to enter the short circuit braking. When the running frequency is lower than P01.09 during the stopping of the VFD, set P13.15 to a non-zero value to enter into stopping short circuited braking and then carry out the DC braking at the time set by P01.12 (refer to the instruction of P01.09–P01.12). Setting range of P13.13: 0.0–150.0% (of the rated output current of the VFD) Setting range of P13.14: 0.00–50.00s Setting range of P13.15: 0.00–50.00s	0.0%	<input type="radio"/>
P13.14	Braking retention time before starting		0.00s	<input type="radio"/>
P13.15	Braking retention time when stopping		0.00s	<input type="radio"/>

P14 Group Serial communication

Function code	Name	Description	Default value	Modify
P14.00	Local communication address	The setting range: 1–247 When the master is writing the frame, the communication address of the slave is set to 0; the broadcast address is the communication address.	1	<input type="radio"/>

Function code	Name	Description	Default value	Modify
		<p>All slaves on the MODBUS fieldbus can receive the frame, but the slave doesn't answer.</p> <p>The communication address of the drive is unique in the communication net. This is the fundamental for the point to point communication between the upper monitor and the drive.</p> <p>Note: The address of the slave cannot set to 0.</p>		
P14.01	Communication baud ratio	<p>Set the digital transmission speed between the upper monitor and the VFD.</p> <p>0: 1200BPS 1: 2400BPS 2: 4800BPS 3: 9600BPS 4: 19200BPS 5: 38400BPS 6: 57600BPS</p> <p>Note: The baud rate between the upper monitor and the VFD must be the same. Otherwise, the communication is not applied. The bigger the baud rate, the quicker the communication speed.</p>	4	○
P14.02	Digital bit checkout	<p>The data format between the upper monitor and the VFD must be the same. Otherwise, the communication is not applied.</p> <p>0: No check (N,8,1) for RTU 1: Even check (E,8,1) for RTU 2: Odd check (O,8,1) for RTU 3: No check (N,8,2) for RTU 4: Even check (E,8,2) for RTU 5: Odd check(O,8,2) for RTU 6: No check (N,7,1) for ASCII 7: Even check (E,7,1) for ASCII 8: Odd check (O,7,1) for ASCII 9: No check (N,7,2) for ASCII 10: Even check (E,7,2) for ASCII 11: Odd check (O,7,2) for ASCII 12: No check (N,8,1) for ASCII 13: Even check (E,8,1) for ASCII 14: Odd check (O,8,1) for ASCII</p>	1	○

Function code	Name	Description	Default value	Modify
		15: No check (N,8,2) for ASCII 16: Even check (E,8,2) for ASCII 17: Odd check (O,8,2) for ASCII		
P14.03	Response delay	0–200ms It means the interval time between the interval time when the drive receive the data and sent it to the upper monitor. If the answer delay is shorter than the system processing time, then the answer delay time is the system processing time, if the answer delay is longer than the system processing time, then after the system deal with the data, waits until achieving the answer delay time to send the data to the upper monitor.	5	○
P14.04	Fault time of communication overtime	0.0 (invalid), 0.1–60.0s When the function code is set as 0.0, the communication overtime parameter is invalid. When the function code is set as non-zero, if the interval time between two communications exceeds the communication overtime, the system will report "485 communication faults" (CE). Generally, set it as invalid; set the parameter in the continuous communication to monitor the communication state.	0.0s	○
P14.05	Transmission fault processing	0: Alarm and stop freely 1: No alarm and continue to run 2: No alarm and stop according to the stop means (only under the communication control) 3: No alarm and stop according to the stop means (under all control modes)	0	○
P14.06	Communication processing	LED ones place: 0: Operation with response: the drive will respond to all reading and writing commands of the upper monitor. 1: Operation without response; The drive only responds to the reading command other than the writing command of the drive. The communication efficiency can be increased by this method. LED tens place: 0: Communication encrypting invalid	0x00	○

Function code	Name	Description	Default value	Modify
		1: Communication encrypting valid LED hundreds place, indicating RS485 communication device type 0: GD200A 1: GD200A user-defined address 2: CHF100A Note: When the LED hundreds place is 1, P14.07 and P14.08 are valid.		
P14.07	User-defined address of running commands	0x0000–0xffff	0x1000	○
P14.08	User-defined address of frequency setting	0x0000–0xffff	0x2000	○

P17 Group Monitoring function

Function code	Name	Description	Default value	Modify
P17.00	Setting frequency	Display current set frequency of the VFD Range: 0.00Hz–P00.03	/	●
P17.01	Output frequency	Display current output frequency of the VFD Range: 0.00Hz–P00.03	/	●
P17.02	Ramp reference frequency	Display current ramp reference frequency of the VFD Range: 0.00Hz–P00.03	/	●
P17.03	Output voltage	Display current output voltage of the VFD Range: 0–1200V	/	●
P17.04	Output current	Display current output current of the VFD Range: 0.0–3000.0A	/	●
P17.05	Motor speed	Display the rotation speed of the motor. Range: 0–65535RPM	/	●
P17.08	Motor power	Display current motor power Range: -300–300%	/	●
P17.09	Output torque	Display the current output torque of the VFD. Range: -250.0–250.0%	/	●

Function code	Name	Description	Default value	Modify																				
P17.10	Evaluated motor frequency	Evaluated frequency of motor rotor Range: 0.00Hz–P00.03	/	●																				
P17.11	DC bus voltage	Display current DC bus voltage of the VFD Range: 0.0–2000.0V	/	●																				
P17.12	ON-OFF input terminals state	Display current Switch input terminals state of the VFD Range: 0000–00FF <table border="1" style="margin-left: 20px;"> <tr> <td></td> <td>BIT8</td> <td>BIT7</td> <td>BIT6</td> <td>BIT5</td> </tr> <tr> <td></td> <td>HDI</td> <td>S8</td> <td>S7</td> <td>S6</td> </tr> <tr> <td>BIT4</td> <td>BIT3</td> <td>BIT2</td> <td>BIT1</td> <td>BIT0</td> </tr> <tr> <td>S5</td> <td>S4</td> <td>S3</td> <td>S2</td> <td>S1</td> </tr> </table>		BIT8	BIT7	BIT6	BIT5		HDI	S8	S7	S6	BIT4	BIT3	BIT2	BIT1	BIT0	S5	S4	S3	S2	S1	/	●
	BIT8	BIT7	BIT6	BIT5																				
	HDI	S8	S7	S6																				
BIT4	BIT3	BIT2	BIT1	BIT0																				
S5	S4	S3	S2	S1																				
P17.13	ON-OFF output terminals state	Display current Switch output terminals state of the VFD <table border="1" style="margin-left: 20px;"> <tr> <td>BIT3</td> <td>BIT2</td> <td>BIT1</td> <td>BIT0</td> </tr> <tr> <td>RO2</td> <td>RO1</td> <td>HDO</td> <td>Y</td> </tr> </table> Range: 0000–000F	BIT3	BIT2	BIT1	BIT0	RO2	RO1	HDO	Y	/	●												
BIT3	BIT2	BIT1	BIT0																					
RO2	RO1	HDO	Y																					
P17.14	Digital adjustment	Display the adjustment through the keypad of the VFD. Range : 0.00Hz–P00.03	/	●																				
P17.15	Torque reference	Display the torque given, the percentage to the current rated torque of the motor. Setting range: -300.0%–300.0% (motor rated current)	/	●																				
P17.16	Linear speed	Display the current linear speed of the VFD. Range: 0–65535	/	●																				
P17.17	Length	Display the current length of the VFD. Range: 0–65535	/	●																				
P17.18	Counting value	Display the current counting number of the VFD. Range: 0–65535	/	●																				
P17.19	AI1 input voltage	It is implemented through the analog potentiometer on the keypad for the 0150G/018P and lower models; not available for the 018G/022P and higher models. Display analog AI1 input signal Range: 0.00–10.00V	/	●																				
P17.20	AI2 input voltage	Display analog AI2 input signal Range: 0.00–10.00V	/	●																				

Function code	Name	Description	Default value	Modify
P17.21	AI3 input voltage	Display analog AI2 input signal Range: -10.00–10.00V	/	●
P17.22	HDI input frequency	Display HDI input frequency Range: 0.000–50.000kHz	/	●
P17.23	PID reference value	Display PID reference value Range: -100.0–100.0%	/	●
P17.24	PID feedback value	Display PID response value Range: -100.0–100.0%	/	●
P17.25	Power factor of the motor	Display the current power factor of the motor. Range: -1.00–1.00	/	●
P17.26	Current running time	Display the current running time of the VFD. Range: 0–65535min	/	●
P17.27	Simple PLC and the current step of multi-step speed	Display simple PLC and the current step of the multi-step speed Range: 0–15	/	●
P17.35	AC input current	Display the input current in AC side. Range: 0.0–5000.0A	/	●
P17.36	Output torque	Display the output torque. Positive value is in the electromotion state, and negative is in the power generating state. Range: -3000.0Nm–3000.0Nm	/	●
P17.37	Counting of the motor overload	0–100 (100 is OL1 fault)	/	●
P17.38	PID output	-100.00–100.00%	0.00%	●
P17.39	Wrong download of parameters	0.00–99.99	0.00	●

P24 Group Water supply

Function code	Name	Description	Default value	Modify
P24.00	Water supply selection	0: Disabled 1: Enabled	0	⊙
P24.01	Press feedback source	0: AI1 setting value (implemented through the analog potentiometer on the keypad for the 0150G/018P and lower models; not available for	0	○

Function code	Name	Description	Default value	Modify
		the 018G/022P and higher models.) 1: AI2 setting value 2: AI3 setting value 3: HDI setting value		
P24.02	Hibernation check	0: Hibernate as the setting frequency < P24.03 1: Hibernate as the feedback pressure > P24.04	0	☉
P24.03	Starting frequency of the hibernation	0.00–P00.03 (the max. frequency)	10.00 Hz	○
P24.04	Starting pressure of hibernation	0.00–100.0%	50.0%	○
P24.05	Hibernation delay time	0.0–3600.0s	5.0s	○
P24.06	Hibernation awake	0: Awake as the setting frequency > P24.07 1: Awake as the feedback pressure < P24.08	0	☉
P24.07	Awake frequency	0.00–P00.03 (the max. frequency)	20.00 Hz	○
P24.08	Setting value of hibernation awake	0.00–100.0%	10.0%	○
P24.09	Min. hibernation time	0.0–3600.0s	5.0s	○
P24.10	Valid auxiliary motor	P24.10–P24.12 can make three motors to form a simple system of water supply.	0	○
P24.11	Start/stop delay time of auxiliary motor 1		5.0s	○
P24.12	Start/stop delay time of auxiliary motor 2	<pre> graph TD Start[Output frequency of the motor] --> D1{>=the upper frequency?} D1 -- Y --> S1[Auxiliary motor start begin delay counting] S1 --> D2{Reach the start delay time} D2 -- Y --> S2[Start the auxiliary motor 1 and 2] D2 -- N --> End((End)) D1 -- N --> D3{=the lower frequency?} D3 -- Y --> S3[Auxiliary motor stop begin delay counting] S3 --> D4{Reach the stop delay time} D4 -- Y --> S4[Stop the auxiliary motor 1 and 2] D4 -- N --> End D3 -- N --> End </pre>	5.0s	○

Function code	Name	Description	Default value	Modify
		<p>P24.10 is used to select the valid auxiliary motor.</p> <p>0: No auxiliary motor 1: Auxiliary motor 1 valid 2: Auxiliary motor 2 valid 3: Auxiliary motor 1 and 2 valid</p> <p>Setting range of P24.11: 0.0–3600.0s Setting range of P24.12: 0.0–3600.0s</p>		

7 Basic operation instruction

7.1 What this chapter contains

This chapter describes the internal function mode of the VFD in details.



- Check all terminals are connected properly and tightly.
- Check that the power of the motor corresponds to that of the VFD.

7.2 First powering on

Check before powering on

Please check according to the installation list in chapter two.

Original powering operation

Check to ensure there is no mistake in wiring and power supply, switch on the air switch of the AC power supply on the input side of the VFD to power on the VFD. 8.8.8.8.8 will be displayed on the keypad, and the contactor closes normally. When the character on the nixie tube changes to the set frequency, the VFD has finished the initialization and it is in the stand-by state.

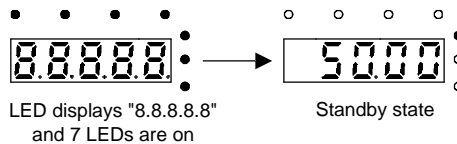

Below diagram shows the first operation: (take motor 1 as the example)

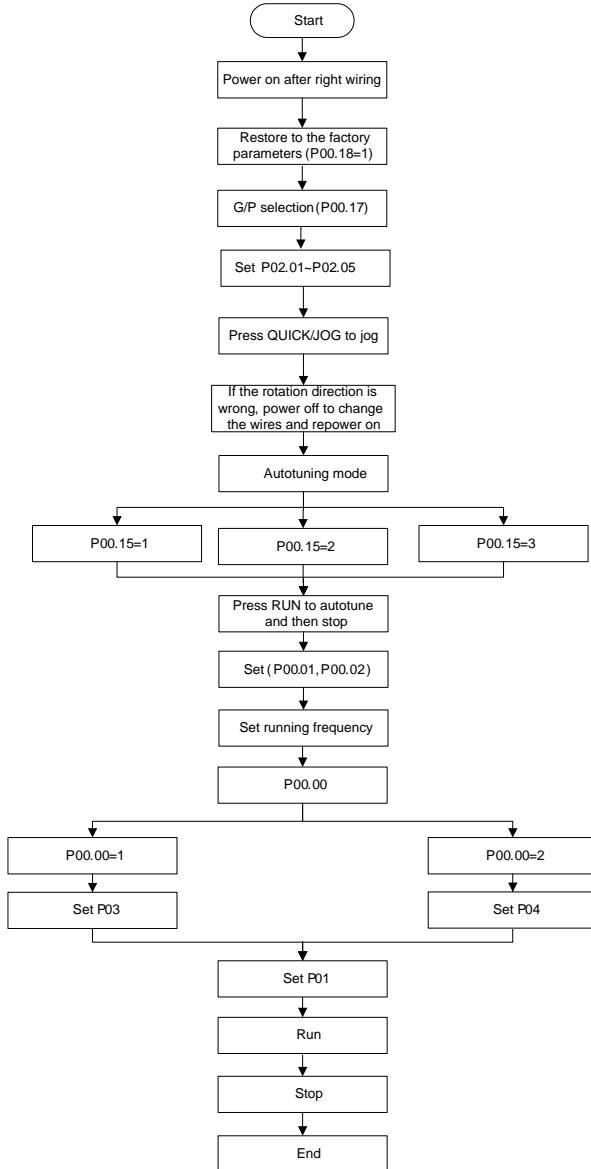

Note: If fault occurs, please do as the "Fault Tracking". Estimate the fault reason and settle the issue.

Besides P00.01 and P00.02, terminal command setting can also be used to set the running command channel.

Current running command channel P00.01	Multi-function terminal 36 Shifting the command to keypad	Multi-function terminal 37 Shifting the command to communication	Multi-function terminal 38 Shifting the command to communication
Keypad running command channel	/	Terminal running command channel	Communication running command channel
Terminal running command channel	Keypad running command channel	/	Communication running command channel
Communication running command channel	Keypad running command channel	Terminal running command channel	/

Note: "/" means the multi-function terminal is invalid on the current reference channel.

7.3 Vector control

Because asynchronous motors have the characteristics of high stage, nonlinear, strong coupling and various variables, the actual control of the asynchronous motor is very difficult. Vector control is mainly used to settle this problem with the theme of that divide the stator current vector into exciting current (the current heft generating internal magnetic field of the motor) and torque current (the current heft generating torque) by controlling and measuring the stator current vector according to the principles of beamed magnetic field to control the range and phase of these two hefts. This method can realize the decoupling of exciting current and torque current to adjust the high performance of asynchronous motors.

Goodrive200A series VFDs are embedded speed sensor-less vector control calculation. Because the core calculation of vector control is based on exact motor parameter models, the accuracy of motor parameter will impact on the performance of vector control. It is recommended to input the motor parameters and carry out autotune before vector running.

Because the vector control calculation is very complicated, high technical theory is needed for the user during internal autotune. It is recommended to use the specific function parameters in vector control with cautions.

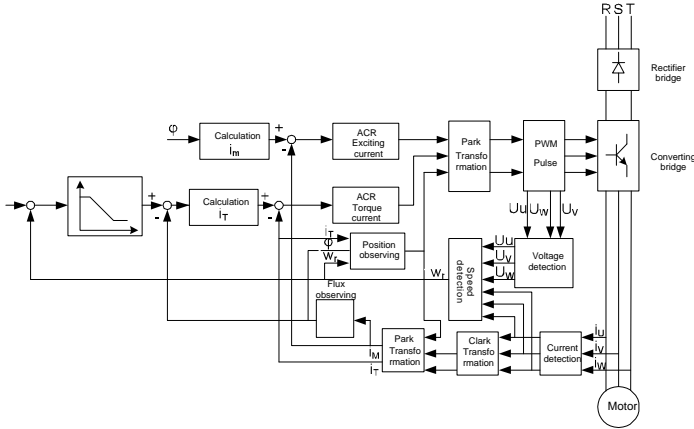

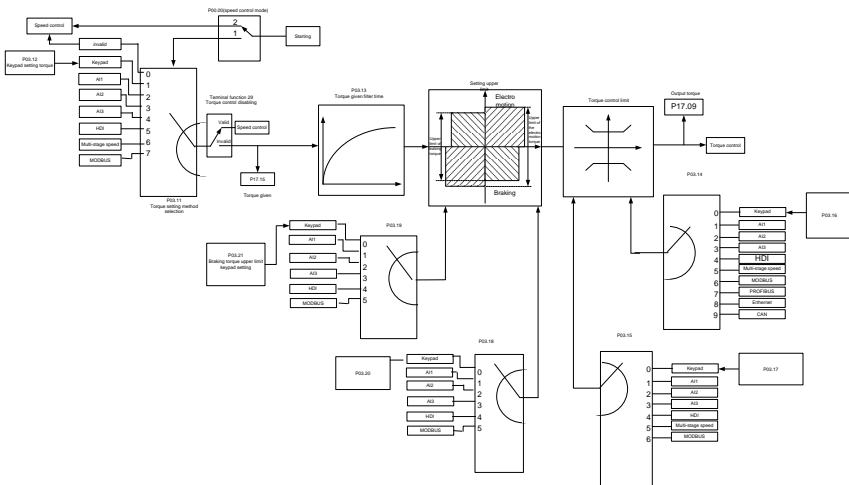

7.4 Torque control

Goodrive200A series VFDs support two kinds of control mode: torque control and rotation speed control. The core of rotation speed is that the whole control focuses on the stable speed and ensures the setting speed is the same as the actual running speed. The max. load should be in the range of the torque limit. The core of torque control is that the whole control focus on the stable torque and ensures the setting torque is the same as the actual output torque. At the same time, the output frequency is among the upper limit or the lower limit.



7.5 Parameters of the motor

	<ul style="list-style-type: none"> ● Physical accident may occur if the motor starts up suddenly during autotune. Please check the safety of surrounding environment of the motor and the load before autotune. ● The power is still applied even the motor stops running during static autotune. Please do not touch the motor until the autotune is completed, otherwise there would be electric shock.
	<ul style="list-style-type: none"> ● Do not carry out the rotation autotune if the motor is coupled with the load, please do not operate on the rotation autotune. Otherwise misacts or damage may occur to the VFD or the mechanical devices. When carry out autotune on the motor which is coupled with load, the motor parameter won't be counted correctly and misacts may occur. It is proper to de-couple the motor from the load during autotune when necessary.

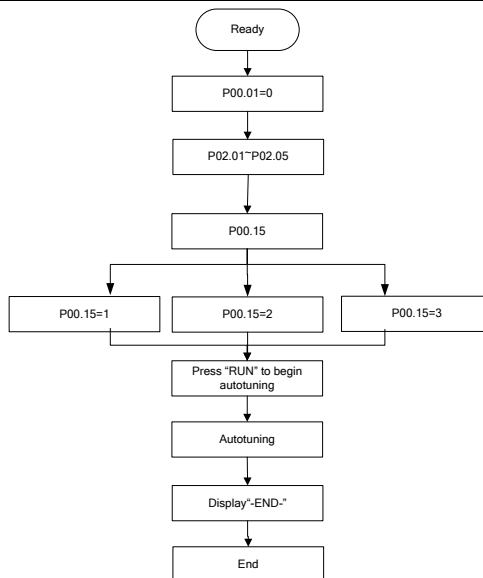

The control performance of the VFD is based on the established accurate motor model. The user has to carry out the motor autotune before first running (take motor 1 as the example).

Note:

1. Set the motor parameters according to the nameplate of the motor.
2. During the motor autotune, de-couple the motor from the load if rotation autotune is selected to make the motor is in a static and empty state, otherwise the result of autotune is incorrect. The asynchronous motors can autotune the parameters of P02.06–P02.10.

3. During the motor autotune 1, do not to de-couple the motor form the load if static autotune is selected. Because only some parameters of the motor are involved, the control performance is not as better as the rotation autotune. The asynchronous motors can autotune the parameters of P02.06–P02.10.

4. During the motor autotune 2, do not to de-couple the motor form the load if static autotune is selected. Because only some parameters of the motor are involved, the control performance is not as better as the rotation autotune. The asynchronous motors can autotune the parameters of P02.06 – P02.08. It is suitable in the cases which SVPWM control is applied.

7.6 Start and stop control

The start and stop control of the VFD includes three states: start after the running command during normal powering on, start after the restarting function becomes valid during normal powering on and start after the automatic fault reset. Below is the detailed instruction for three starting.

There are three starting modes for the VFD: start from the starting frequency directly, start after the DC braking and start after the rotation speed tracking. The user can select according to different situations to meet their needs.

For the load with big inertia, especially in the cases where the reverse rotation may occur, it is better to select starting after DC braking and then starting after rotation speed tracking.

1. The starting logic figure of starting after the running command during the normal powering on:

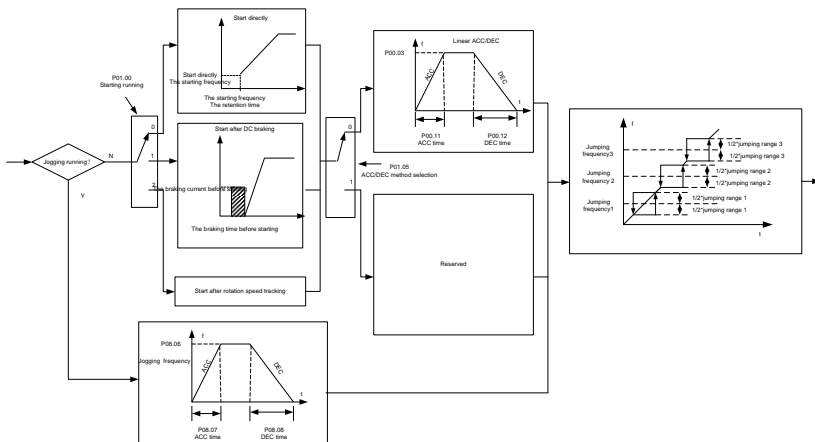

2. The starting logic figure of starting after the restarting function becomes valid during the normal powering on:

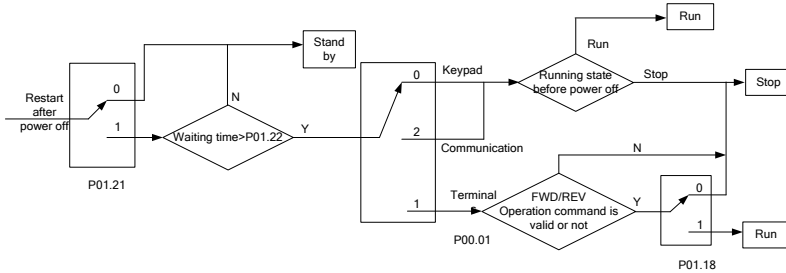

3. The starting logic figure of starting after the automatic fault reset:

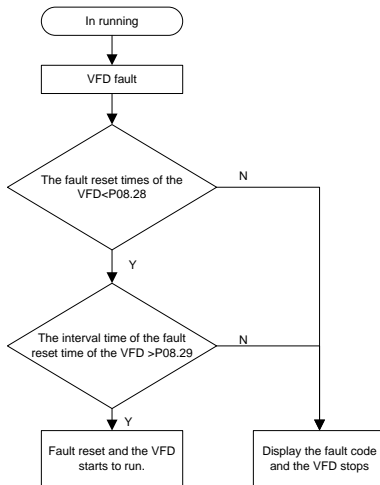

7.7 Frequency setting

Goodrive200A series VFDs can set the frequency by various means. The reference channel can be divided into main reference channel and assistant reference channel.

There are two main reference channels: A frequency reference channel and B frequency reference channel. These two reference channels can carry out mutual simple math calculation between each other. And the reference channels can be shifted dynamically through set multi- function terminals.

There are three assistant reference channels: keypad UP/DOWN input, terminals UP/DOWN switch input and digital potentiometer input. The three ways equal to the effect of input UP/DOWN reference in internal assistant reference of the VFD. The user can enable the reference method and the effect of the method to the frequency reference by setting function codes.

The actual reference of the VFD is consisted of main reference channel and assistant reference channel.

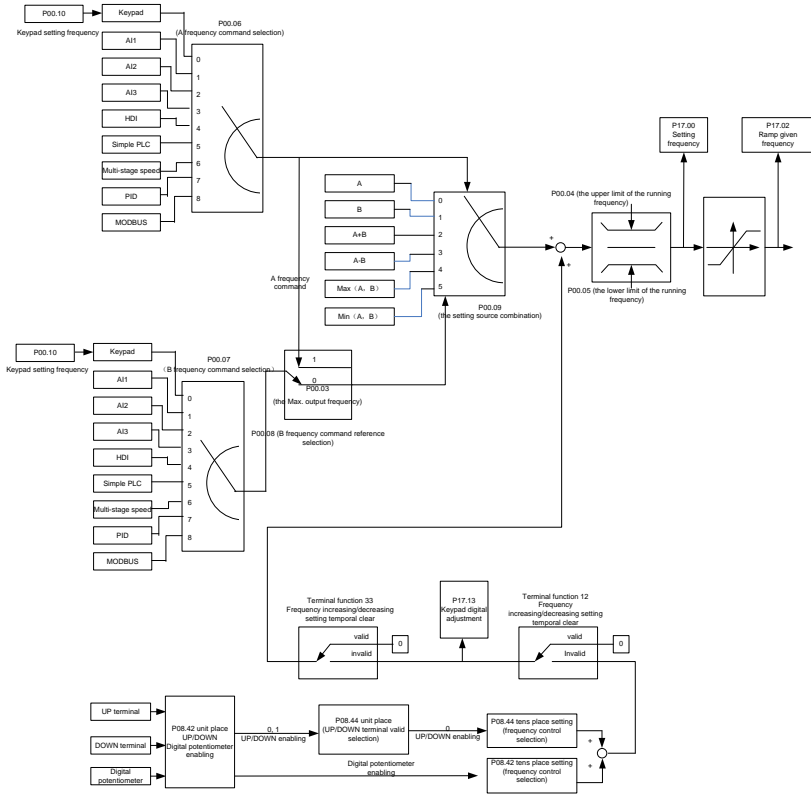

Goodrive200A series VFDs support the shifting between different reference channels and the detailed shifting rules is as below:

Current reference channel P00.09	Multi-function terminal function 13 Shifting from A channel to B channel	Multi-function terminal function 14 Shifting from combination setting to A channel	Multi-function terminal function 15 Shifting from combination setting to B channel
A	B	/	/
B	A	/	/
A+B	/	A	B
A-B	/	A	B
Max(A,B)	/	A	B
Min(A,B)	/	A	B

Note: "/" means the multi-function terminal is invalid under the current reference channel.

When multi-function terminals UP (10) and DOWN (11) are used to set the internal assistant frequency, P08.45 and P08.46 can be set to increase or decrease the set frequency quickly.

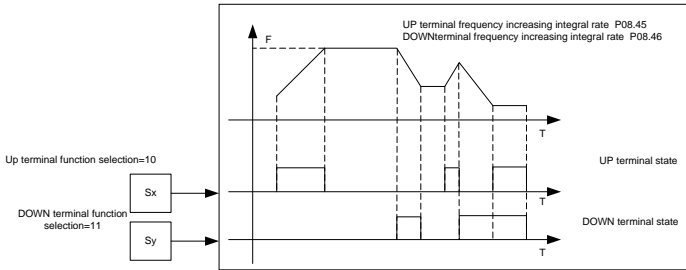

7.8 Simple PLC

Simple PLC function is also a multi-step speed generator. The VFD can change the running frequency, direction to meet the need of processing according to the running time automatically. In the past, this function needs to be assisted by external PLC, but now the VFD can realize this function by itself.

The series VFDs can control 16-step speed with 4 groups of ACC/DEC time.

The multi-function digital output terminals or multi-function relay output an ON signal when the set PLC finishes a circle (or a step).

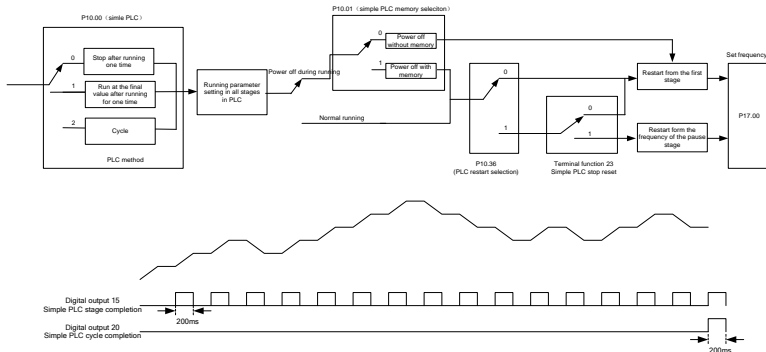

7.9 Multi-step speed running

Set the parameters when the VFD carries out multi-step speed running. Goodrive200A series VFDs can set 16 step speed which can be selected by the combination code of multi-step speed terminals 1-4. They correspond to multi-step speed 0 to 15.

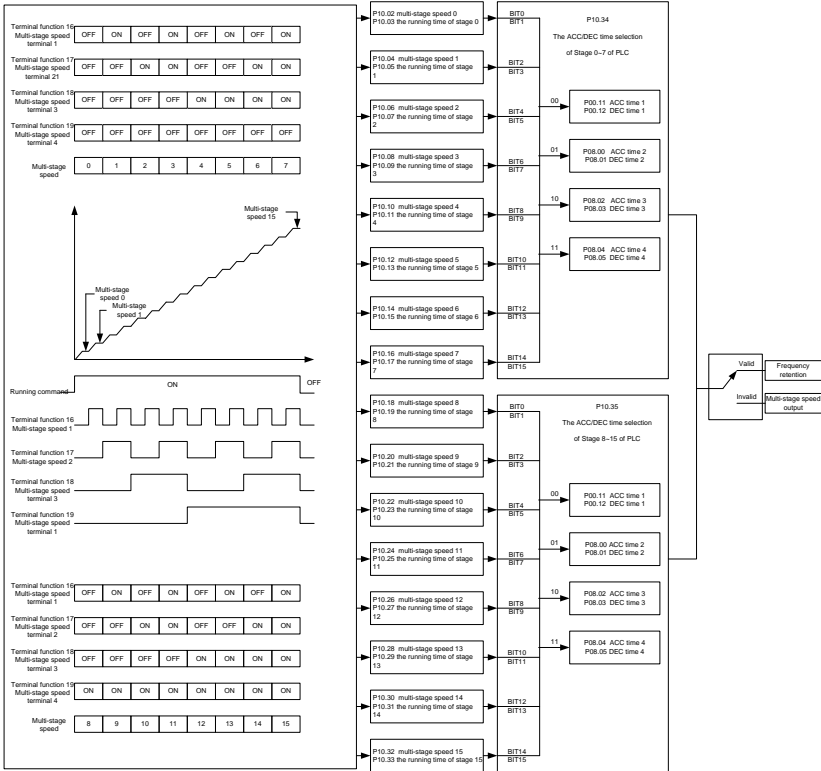

7.10 PID control

PID control is commonly used to control the procedure. Adjust the output frequency by proportional, integral, differential operation with the dispersion of the target signals to stabilize the value on the target. It is possible to apply to the flow, pressure and temperature control. Figure of basic control is as below:

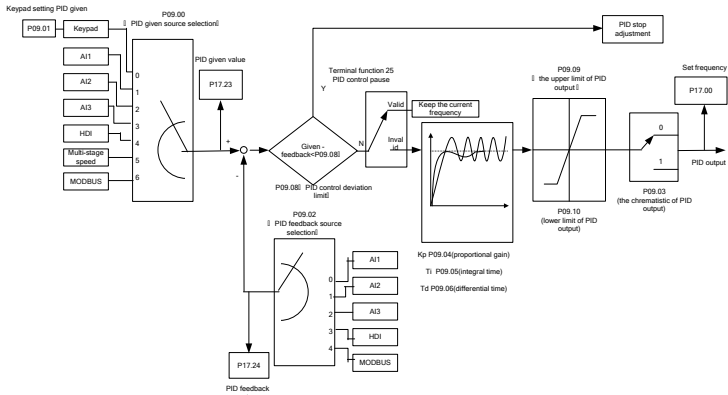

When P00.06, P00.07=7 or P04.27=6, the running mode of the VFD is procedure PID control.

7.10.1 General steps of PID parameters setting:

a Ensure the gain P

When ensure the gain P, firstly cancel the PID integration and derivation (set $T_i=0$ and $T_d=0$, see the PID parameter setting for detailed information) to make proportional adjustment is the only method to PID. Set the input as 60%–70% of the permitted max. value and increase gain P from 0 until the system vibration occurs, vice versa, and record the PID value and set it to 60%–70% of the current value. Then the gain P commission is finished.

b Ensure the integration time

After ensuring the gain P, set an original value of a bigger integration time and decrease it until the system vibration occurs, vice versa, until the system vibration disappear. Record the T_i and set the integration time to 150%–180% of the current value. Then integration time commission is finished.

c Ensure the derivation time

Generally, it is not necessary to set T_d which is 0.

If it needs to be set, set it to 30% of the value without vibration via the same method with P and T_i .

d Commission the system with and without load and then adjust the PID parameter until it is available.

7.10.2 PID inching

After setting the PID control parameters, inching is possible by following means:

Control the overshoot

Shorten the derivation time and prolong the integration time when overshoot occurs.

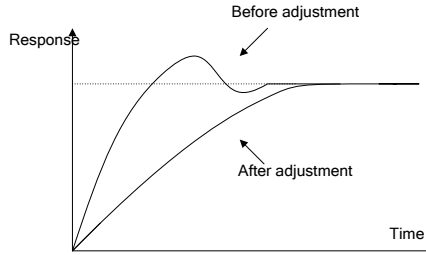

Achieve the stable state as soon as possible

Shorten the integration time (T_i) and prolong the derivation time (T_d) even the overshoot occurs, but the control should be stable as soon as possible.

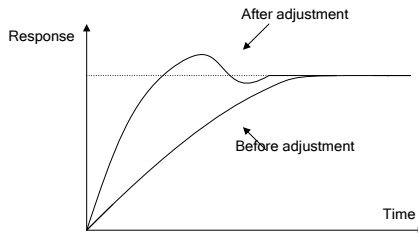

Control long vibration

If the vibration periods are longer than the set value of integration time (T_i), it is necessary to prolong the integration time (T_i) to control the vibration for the strong integration.

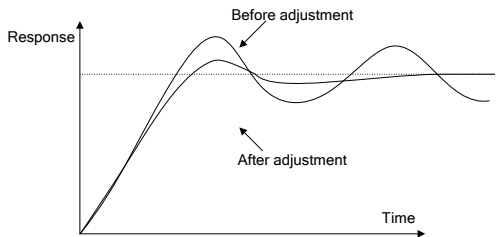

Control short vibration

Short vibration period and the same set value with the derivation time (T_d) mean that the derivation time is strong. Shortening the derivation time (T_d) can control the vibration. When setting the derivation time as 0.00 (no derivation control) is useless to control the vibration, decrease the gain.

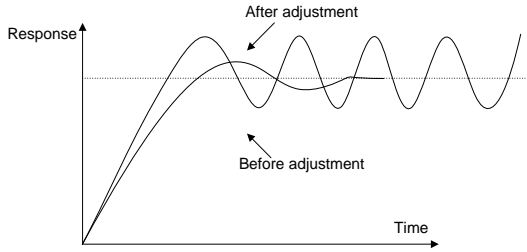

7.11 Pulse counter

Goodrive200A series VFDs support pulse counter which can input counting pulse through HDI terminal. When the actual length is longer than or equal to the set length, the digital output terminal can output length arrival pulse signal and the corresponding length will be cleared automatically.

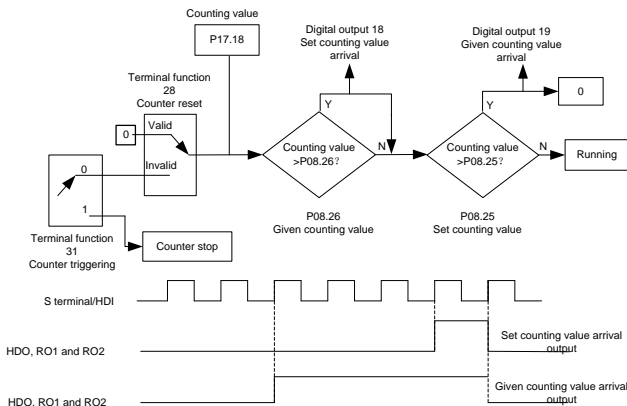
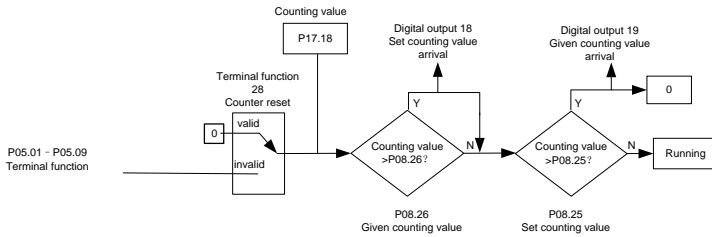

8 Fault tracking

8.1 What this chapter contains

This chapter describes how to reset faults and view fault history. It also lists all alarm and fault messages including the possible cause and corrective actions.



- Only qualified electricians are allowed to maintain the VFD. Read the safety instructions in chapter Safety precautions before working on the VFD.

8.2 Alarm and fault indications

Fault is indicated by LEDs. See 5 Keypad operation procedure. When **TRIP** light is on, an alarm or fault message on the panel display indicates abnormal VFD state. Using the information reference in this chapter, most alarm and fault cause can be identified and corrected. If not, contact INVT office..

8.3 How to reset

The VFD can be reset by pressing the keypad key **STOP/RS1**, through digital input, or by switching the power light. When the fault has been removed, the motor can be restarted.

8.4 Fault history

Function codes P07.27–P07.32 store 6 recent faults. Function codes P07.33 – P07.40, P07.41 – P07.48 and P07.49 – P07.56 show drive operation data when the latest 3 faults occurs.

8.5 Fault instruction and solution

Do as the following after the VFD fault:

1. Check to ensure there is nothing wrong with the keypad. If not, please contact local INVT office.
2. If there is nothing wrong, please check P07 and ensure the corresponding recorded fault parameters to confirm the real state when the current fault occurs by all parameters.
3. See the following table for detailed solution and check the corresponding abnormal state.
4. Eliminate the fault and ask for relative help.
5. Check to eliminate the fault and carry out fault reset to run the VFD.

8.5.1 Fault instruction and solution

Note: The numbers enclosed in square brackets such as [1], [2] and [3] in the Fault type column in the following table indicate the VFD fault type codes read through communication.

Fault code	Fault type	Possible cause	What to do
OUT1	[1] IGBT Ph-U fault	●The acceleration is too fast	●Increase acceleration time
OUT2	[2] IGBT Ph-V fault	●IGBT module fault	●Change the power unit
OUT3	[3] IGBT Ph-W fault	●Misacts caused by	●Check the driving wires

Fault code	Fault type	Possible cause	What to do
		interference ●The connection of the driving wires is not good, ●Grounding is not properly	●Inspect external equipment and eliminate interference
OC1	[7] Over-current when acceleration	●The acceleration or deceleration is too fast ●The voltage of the grid is too low ●The power of the VFD is too low	●Increase the ACC time ●Check the input power ●Select the VFD with a larger power ●Check if the load is short circuited (the grounding short circuited or the wire short circuited) or the rotation is not smooth
OC2	[8] Over-current when deceleration	●The load transients or is abnormal ●The grounding is short circuited or the output is phase loss	●Check the output configuration.
OC3	[9] Over-current when constant speed running	●There is strong external interference ●The overvoltage stall protection is not open	●Check if there is strong interference ●Check the setting of relative function codes
OV1	[4] Over-voltage when acceleration	●The input voltage is abnormal ●There is large energy feedback ●No braking components ●Braking energy is not open	●Check the input power ●Check if the DEC time of the load is too short or the VFD starts during the rotation of the motor or it needs to add the dynamic braking components ●Install the braking components ●Check the setting of relative function codes
OV2	[5] Over-voltage when deceleration		
OV3	[6] Over-voltage when constant speed running		
UV	[10] DC bus Under-voltage	●The voltage of the power supply is too low ●The overvoltage stall protection is not open	●Check the input power of the supply line ●Check the setting of relative function codes
OL1	[11] Motor overload	●The voltage of the power supply is too low ●The motor setting rated current is incorrect ●The motor stall or load transients is too strong	●Check the power of the supply line ●Reset the rated current of the motor ●Check the load and adjust the torque lift

Fault code	Fault type	Possible cause	What to do
OL2	[12] VFD overload	<ul style="list-style-type: none"> ●The acceleration is too fast ●Reset the rotating motor ●The voltage of the power supply is too low ●The load is too heavy ●The motor power is too small 	<ul style="list-style-type: none"> ●Increase the ACC time ●Avoid the restarting after stopping ●Check the power of the supply line ●Select a VFD with bigger power ●Select a proper motor
SPI	[13] Input phase loss	<ul style="list-style-type: none"> ●Phase loss or fluctuation of input R,S,T 	<ul style="list-style-type: none"> ●Check input power ●Check installation distribution
SPO	[14] Output phase loss	<ul style="list-style-type: none"> ●U,V,W phase loss input(or serious asymmetrical three phase of the load) 	<ul style="list-style-type: none"> ●Check the output distribution ●Check the motor and cable
OH1	[15] Rectify overheat	<ul style="list-style-type: none"> ●Air duct jam or fan damage ●Ambient temperature is too high ●The time of overload running is too long 	<ul style="list-style-type: none"> ●Clean the air duct or the fan ●Reduce the ambient temperature
OH2	[16] IGBT overheat		
EF	[17] External fault	<ul style="list-style-type: none"> ●SI external fault input terminals action 	<ul style="list-style-type: none"> ●Check the external device input
CE	[18] Communication error	<ul style="list-style-type: none"> ●The baud rate setting is incorrect ●Fault occurs to the communication wiring. ●The communication address is wrong ●There is strong interference to the communication 	<ul style="list-style-type: none"> ●Set proper baud rate ●Check the communication connection distribution ●Set proper communication address ●Chang or replace the connection distribution or improve the anti-interference capability
ItE	[19] Current detection fault	<ul style="list-style-type: none"> ●The connection of the control board is not good ●Hall components is broken ●The modifying circuit is abnormal 	<ul style="list-style-type: none"> ●Check the connector and re-plug ●Change the hall ●Change the main control panel
tE	[20] Autotuning fault	<ul style="list-style-type: none"> ●The motor capacity does not comply with the VFD capability ●The rated parameter of the 	<ul style="list-style-type: none"> ●Change the VFD model ●Set the rated parameter according to the motor nameplate

Fault code	Fault type	Possible cause	What to do
		motor does not set correctly. ●The offset between the parameters autotuning and the standard parameter is huge ●Autotune overtime	●Empty the motor load and re-identify ●Check the motor connection and set the parameter. ●Check if the upper limit frequency is above 2/3 of the rated frequency.
EEP	[21] EEPROM fault	●Error of controlling the write and read of the parameters ●Damage to EEPROM	●Press STOP/RST to reset ●Change the main control panel
PIDE	[22] PID feedback fault	●PID feedback offline ●PID feedback source disappear	●Check the PID feedback signal ●Check the PID feedback source
bCE	[23] Braking unit fault	●Braking circuit fault or damage to the braking pipes ●The external braking resistor is not sufficient	●Check the braking unit and change new braking pipe ●Increase the braking resistor
END	[24] Time reach of factory setting	●The actual running time of the VFD is above the internal setting running time	●Ask for the supplier and adjust the setting running time
OL3	[25] Electrical overload	●The VFD will report overload pre-alarm according to the set value	●Check the load and the overload pre-alarm point.
PCE	[26] Keypad communication fault	●The connection of the keypad wires is not good or broken ●The keypad wire is too long and affected by strong interference ●There is circuit fault on the communication of the keypad and main board	●Check the keypad wires and ensure whether there is mistake ●Check the environment and avoid the interference source ●Change the hardware and ask for service
UPE	[27] Parameter uploading fault	●The keypad is not in good connection or offline; ●The keypad cable is too long and there is strong interference;	●Check the environment and eliminate the interference source; ●Change hardware and ask for maintenance service;

Fault code	Fault type	Possible cause	What to do
		<ul style="list-style-type: none"> ●Part of the communication circuits of the keypad or main board have fault. 	<ul style="list-style-type: none"> ●Change hardware and ask for maintenance service.
DNE	[28] Parameter downloading fault (DNE)	<ul style="list-style-type: none"> ●The keypad is not in good connection or offline; ●The keypad cable is too long and there is strong interference; ●Data storage error in keypad. 	<ul style="list-style-type: none"> ●Check the environment and eliminate the interference source; ●Change hardware and ask for maintenance service; ●Back up data in the keypad again.
ETH1	[32] Grounding shortcut fault 1	<ul style="list-style-type: none"> ●The output of the VFD is short circuited with the ground 	<ul style="list-style-type: none"> ●Check if the connection of the motor is normal or not
ETH2	[33] Grounding shortcut fault 2	<ul style="list-style-type: none"> ●There is fault in the current detection circuit ●The actual motor power sharply differs from the VFD power. 	<ul style="list-style-type: none"> ●Change the hall ●Change the main control panel ●Set motor parameters correctly.
LL	[36] Electronic underload fault	<ul style="list-style-type: none"> ●The VFD will report the underload pre-alarm according to the set value 	<ul style="list-style-type: none"> ●Check the load and the underload pre-alarm point

8.5.2 Other states

Fault code	Fault type	Possible cause	What to do
PoFF	System power off	System power off or the bus voltage is too low	Check the grid
	Communication failure between the keypad and main control board	The keypad is not connected correctly	Check the installation environment

8.6 Common fault analysis

8.6.1 The motor does not work

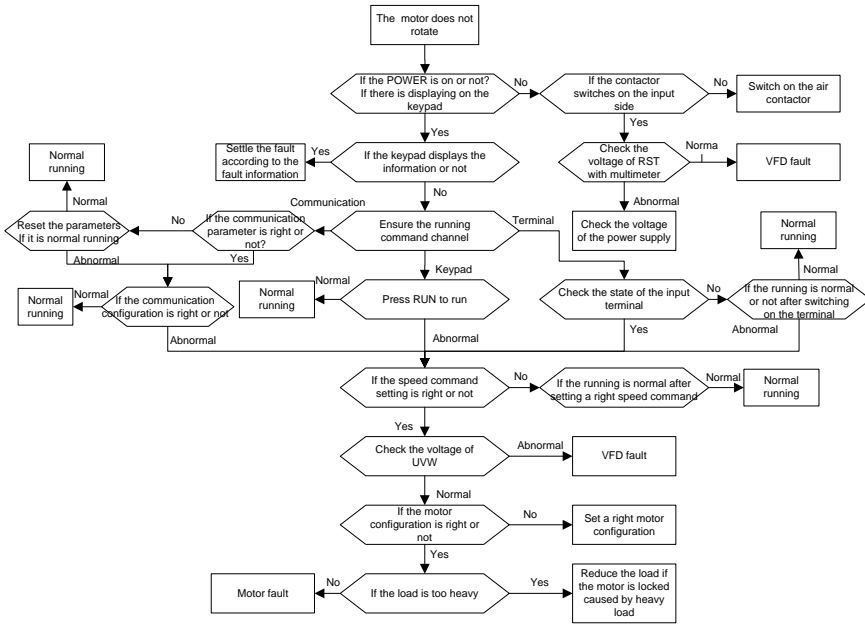

8.6.2 Motor vibration

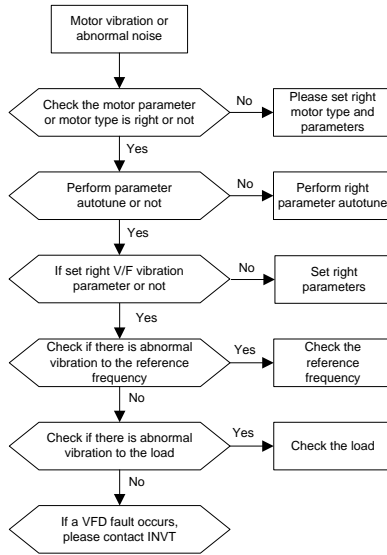

8.6.3 Overvoltage

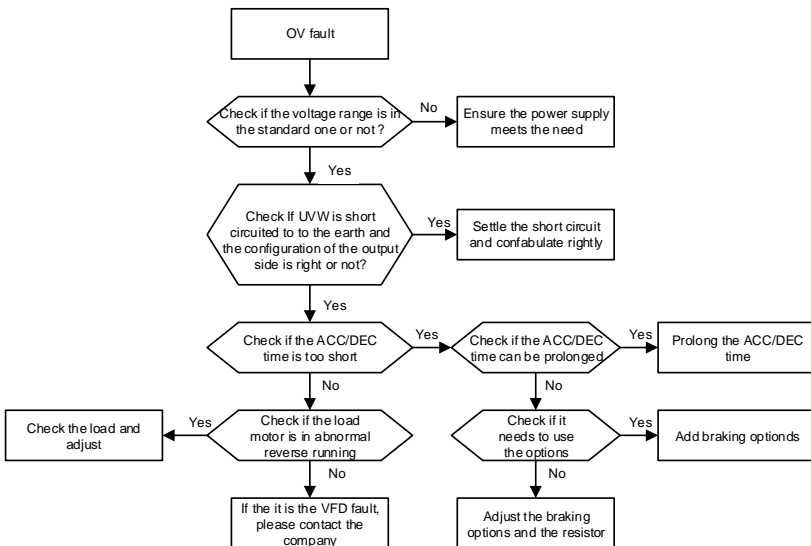

8.6.4 Undervoltage fault

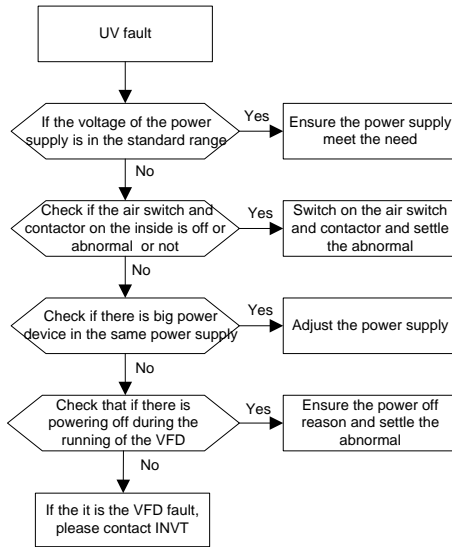

8.6.5 Abnormal motor heat

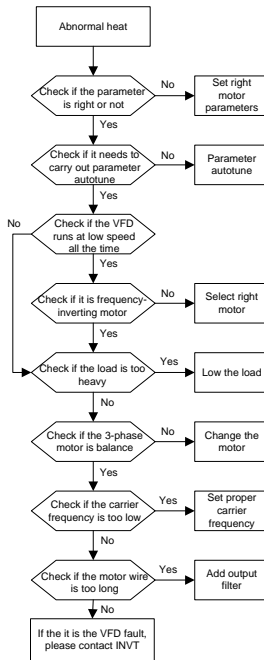

8.6.6 VFD overheating

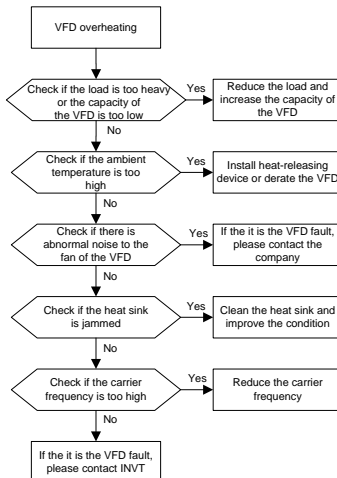

8.6.7 Stall during the acceleration of the motor

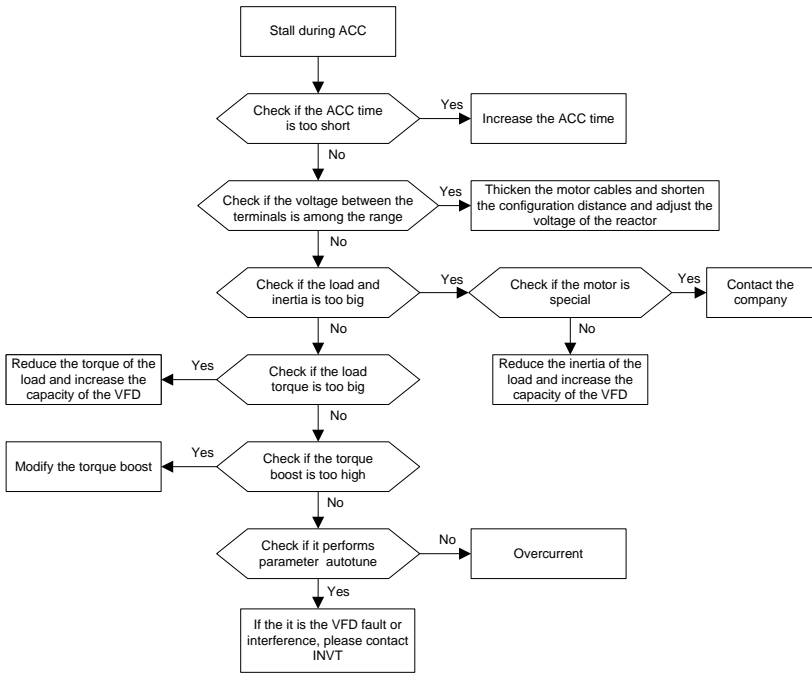

8.6.8 Overcurrent

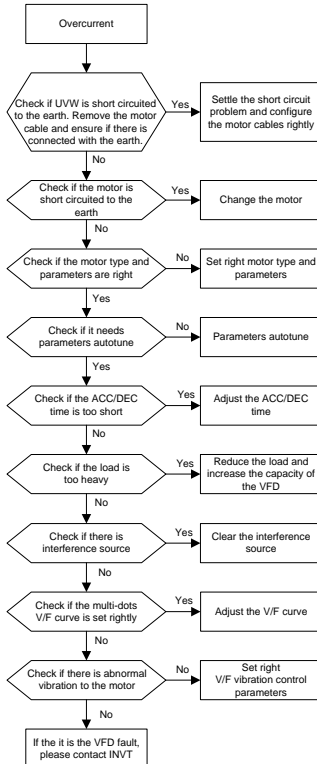

8.7 VFD system interference troubleshooting

If sensitive devices (PLC, PC, sensors, test equipment, etc.) exist interference problems when the system is running, you can troubleshoot by the following means:

1. Try plugging in or unplugging the jumper pins of C3 filter to verify whether the interference has been eliminated.
2. Check whether the drive power lines and the signal/ communication lines of sensitive equipment go down the same trough, if there is, it should be again separated from the wiring.
3. If the sensitive equipment and drive to take power from the same grid, it is recommended to install isolation transformer and filter to the distribution of sensitive equipment side.
4. The relative shield wire of sensitive equipment try to ground at both ends、 single-grounded、 ungrounded respectively; to verify whether the interference has been eliminated.
5. Try to make the interfered sensitive equipment and the drive have no common ground, or floating processing; to verify whether the interference has been eliminated.

8.8 Maintenance and hardware diagnostics

8.8.1 Overcurrent

If installed in an appropriate environment, the VFD requires very little maintenance. The table lists the recommended routine maintenance intervals recommended by INVT.

Checking part		Checking item	Checking method	Criterion
Ambient environment		Check the ambient temperature, humidity and vibration and ensure there is no dust, gas, oil fog and water drop.	Visual examination and instrument test	Conforming to the manual
		Ensure there are no tools or other foreign or dangerous objects	Visual examination	There are no tools or dangerous objects.
Voltage		Ensure the main circuit and control circuit are normal.	Measurement by millimeter	Conforming to the manual
Keypad		Ensure the display is clear enough	Visual examination	The characters are displayed normally.
		Ensure the characters are displayed totally	Visual examination	Conforming to the manual
Main circuit	For public use	Ensure the screws are tightened up	Tighten up	NA
		Ensure there is no distortion, crackles, damage or color-changing caused by overheating and aging to the machine and insulator.	Visual examination	NA
		Ensure there is no dust and dirtiness	Visual examination	NA Note: If the color of the copper blocks change, it does not mean that there is something wrong with the features.
	The lead of the conductors	Ensure that there is no distortion or color-changing of the conductors caused by overheating.	Visual examination	NA
		Ensure that there are no crackles or color-changing of the protective layers.	Visual examination	NA

Checking part		Checking item	Checking method	Criterion
	Terminals seat	Ensure that there is no damage	Visual examination	NA
	Filter capacitors	Ensure that there is no weeping, color-changing, crackles and cassis expansion.	Visual examination	NA
		Ensure the safety valve is in the right place.	Estimate the usage time according to the maintenance or measure the static capacity.	NA
		If necessary, measure the static capacity.	Measure the capacity by instruments.	The static capacity is above or equal to the original value *0.85.
	Resistors	Ensure whether there is replacement and splitting caused by overheating.	Smelling and visual examination	NA
		Ensure that there is no offline.	Visual examination or remove one ending to coagulate or measure with multimeters	The resistors are in $\pm 10\%$ of the standard value.
	Transformers and reactors	Ensure there is no abnormal vibration, noise and smelling,	Hearing, smelling and visual examination	NA
	Electromagnetism contactors and relays	Ensure whether there is vibration noise in the workrooms.	Hearing	NA
		Ensure the contactor is good enough.	Visual examination	NA
	Control circuit	PCB and plugs	Ensure there are no loose screws and contactors.	Fasten up
Ensure there is no smelling and color-changing.			Smelling and visual examination	NA
Ensure there are no crackles, damage distortion and rust.			Visual examination	NA

Checking part		Checking item	Checking method	Criterion
		Ensure there is no weeping and distortion to the capacitors.	Visual examination or estimate the usage time according to the maintenance information	NA
Cooling system	Cooling fan	Estimate whether there is abnormal noise and vibration.	Hearing and Visual examination or rotate with hand	Stable rotation
		Estimate there is no losses screw.	Tighten up	NA
		Ensure there is no color-changing caused by overheating.	Visual examination or estimate the usage time according to the maintenance information	NA
	Ventilating duct	Ensure whether there is stuff or foreign objection in the cooling fan, air vent.	Visual examination	NA

Consult the local service representative for more details on the maintenance. Visit the official website of INVT <http://www.invt.com> and choose **Service**.

8.8.2 Cooling fan

The VFD's cooling fan has a minimum life span of 25,000 operating hours. The actual life span depends on the VFD usage and ambient temperature.

The operating hours can be found through P07.14 (accumulative hours of the VFD).

Fan failure can be predicted by the increasing noise from the fan bearings. If the VFD is operated in a critical part of a process, fan replacement is recommended once these symptoms appear. Replacement fans are available from INVT.

8.8.2.1 Replacing the cooling fan

	<ul style="list-style-type: none"> ● Read and follow the instructions in chapter 1 Safety precautions. Ignoring the instructions would cause physical injury or death, or damage to the equipment.
---	---

1. Stop the VFD and disconnect it from the AC power source and wait for at least the time designated on the VFD.
2. Lever the fan holder off the drive frame with a screwdriver and lift the hinged fan holder slightly upward from its front edge.
3. Loosen the fan cable from the clip.
4. Disconnect the fan cable.
5. Remove the fan holder from the hinges.
6. Install the new fan holder including the fan in reverse order. Keep the wind direction of the fan consistent with that of the VFD, as shown below:

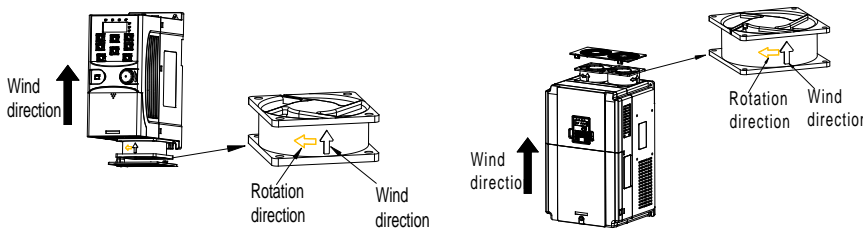

Figure 8-1 Fan maintenance diagram for VFDs

7. Restore power.

8.8.3 Capacitors

8.8.3.1 Reforming the capacitors

The DC bus capacitors must be reformed according to the operation instruction if the VFD has been stored for a long time. The storing time is counted from the producing date other than the delivery data which has been marked in the serial number of the VFD.

Time	Operational principle
Storing time less than 1 year	Operation without charging
Storing time 1-2 years	Connect with the power for 1 hour before first ON command
Storing time 2-3 years	Use power surge to charge for the VFD <ul style="list-style-type: none"> ● Apply 25% rated voltage for 30 minutes ● Apply 50% rated voltage for 30 minutes ● Apply 75% rated voltage for 30 minutes ● Apply 100% rated voltage for 30 minutes
Storing time more than 3 years	Use power surge to charge for the VFD <ul style="list-style-type: none"> ● Apply 25% rated voltage for 2 hours ● Apply 50% rated voltage for 2 hours ● Apply 75% rated voltage for 2 hours ● Apply 100% rated voltage for 2 hours

The method of using power surge to charge for the VFD:

The right selection of power surge depends on the supply power of the VFD. Single phase 220V AC/2A power surge applied to the VFD with single/three-phase 220V AC as its input voltage. The VFD with single/three-phase 220V AC as its input voltage can apply Single phase 220V AC/2A power surge. All DC bus capacitors charge at the same time because there is one rectifier.

High-voltage VFD needs enough voltage (for example, 380V) during charging. The small capacitor power (2A is enough) can be used because the capacitor nearly does not need current when charging.

The operation method of VFD charging through resistors (LEDs):

The charging time is at least 60 minutes if charge the DC bus capacitor directly through supply power. This operation is available on normal temperature and no-load condition and the resistor should be serially connected in the 3-phase circuits of the power supply(the distance between resistors of each phase \geq 5.5mm):

380V drive device: 1k/100W resistor. LED of 100W can be used when the power voltage is no more than 380V. But if used, the light may be off or weak during charging.

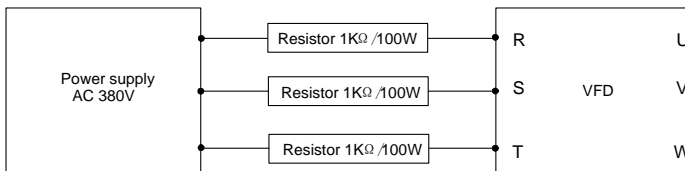

Figure 8-2 380V charging illustration of the driven device

8.8.3.2 Change electrolytic capacitors



- Read and follow the instructions in chapter 1 Safety precautions. Ignoring the instructions may cause physical injury or death, or damage to the equipment.

Change electrolytic capacitors if the working hours of electrolytic capacitors in the VFD are above 35000. Please contact the local INVT offices or dial our national service hotline (400-700-9997) for detailed operation.

8.8.4 Power cable



- Read and follow the instructions in chapter 1 Safety precautions. Ignoring the instructions may cause physical injury or death, or damage to the equipment.

1. Stop the drive and disconnect it from the power line. Wait for at least the time designated on the VFD.
2. Check the tightness of the power cable connections.
3. Restore power.

9 Communication protocol

9.1 What this chapter contains

This chapter describes the communication protocol of Goodrive200A series VFDs.

The Goodrive200A series VFDs provide RS485 communication interface. It adopts international standard MODBUS communication protocol to perform master-slave communication. The user can realize centralized control through PC/PLC, upper control PC, etc. (set the control command, running frequency of the VFD, modify relevant function codes, monitor and control the operating state and fault information of the VFD and so on) to adapt specific application requirements.

9.2 Brief instruction to MODBUS protocol

MODBUS protocol is a software protocol and common language which is applied in the electrical controller. With this protocol, the controller can communicate with other devices via network (the channel of signal transmission or the physical layer, such as RS485). And with this industrial standard, the controlling devices of different manufacturers can be connected to an industrial network for the convenient of being monitored.

There are two transmission modes for MODBUS protocol: ASCII mode and RTU (Remote Terminal Units) mode. On one MODBUS network, all devices should select same transmission mode and their basic parameters, such as baud rate, digital bit, check bit, and stopping bit should have no difference.

MODBUS network is a controlling network with single-master and multiple slaves, which means that there is only one device performs as the master and the others are the slaves on one MODBUS network. The master means the device which has active talking right to send message to MODBUS network for the controlling and inquiring to other devices. The slave means the passive device which sends data message to the MODBUS network only after receiving the controlling or inquiring message (command) from the master (response). After the master sends message, there is a period of time left for the controlled or inquired slaves to response, which ensure there is only one slave sends message to the master at a time for the avoidance of singles impact.

Generally, the user can set PC, PLC, IPC and HMI as the masters to realize central control. Setting certain device as the master is a promise other than setting by a bottom or a switch or the device has a special message format. For example, when the upper monitor is running, if the operator clicks sending command bottom, the upper monitor can send command message actively even it cannot receive the message from other devices. In this case, the upper monitor is the master. And if the designer makes the VFD send the data only after receiving the command, then the VFD is the slave.

The master can communicate with any single slave or with all slaves. For the single-visiting command, the slave should feedback a response message; for the broadcasting message from the master, the slave does not need to feedback the response message.

9.3 Application of the VFD

The MODBUS protocol of the VFD is RTU mode and the physical layer is 2-wire RS485.

9.3.1 RS485

The interface of 2-wire RS485 works on semiduplex and its data signal applies differential transmission which is called balance transmission, too. It uses twisted pairs, one of which is defined as A (+) and the other is defined as B (-). Generally, if the positive electrical level between sending drive A and B is among +2~+6V, it is logic"1", if the electrical level is among -2V~-6V; it is logic"0".

485+ on the terminal board corresponds to A and 485- to B.

Communication baud rate means the binary bit number in one second. The unit is bit/s (bps). The higher the baud rate is, the quicker the transmission speed is and the weaker the anti-interference is. If the twisted pairs of 0.56mm (24AWG) is applied as the communication cables, the max. transmission distance is as below:

Baud rate	Max. transmission distance	Baud rate	Max. transmission distance
2400BPS	1800m	9600BPS	800m
4800BPS	1200m	19200BPS	600m

It is recommended to use shield cables and make the shield layer as the grounding wires during RS485 remote communication.

In the cases with less devices and shorter distance, it is recommended to use 120Ω terminal resistor as the performance will be weakened if the distance increase even though the network can perform well without load resistor.

9.3.2 RTU mode

9.3.2.1 RTU communication frame format

If the controller is set to communicate by RTU mode in MODBUS network every 8bit byte in the message includes two 4Bit hex characters. Compared with ACSII mode, this mode can send more data at the same baud rate.

Code system

- 1 start bit
- 7 or 8 digital bit, the minimum valid bit can be sent firstly. Every 8 bit frame includes two hex characters (0...9, A...F)
- 1 even/odd check bit . If there is no checkout, the even/odd check bit is inexistent.
- 1 end bit (with checkout), 2 Bit(no checkout)

Error detection field

● CRC

The data format is illustrated as below:

11-bit character frame (BIT1 - BIT8 are the digital bits)

Start bit	BIT1	BIT2	BIT3	BIT4	BIT5	BIT6	BIT7	BIT8	Check bit	End bit
-----------	------	------	------	------	------	------	------	------	-----------	---------

10-bit character frame (BIT1 - BIT7 are the digital bits)

Start bit	BIT1	BIT2	BIT3	BIT4	BIT5	BIT6	BIT7	Check bit	End bit
-----------	------	------	------	------	------	------	------	-----------	---------

In one character frame, the digital bit takes effect. The start bit, check bit and end bit is used to send the digital bit right to the other device. The digital bit, even/odd checkout and end bit should be set as the same in real application.

The MODBUS minimum idle time between frames should be no less than 3.5 bytes. The network device is detecting, even during the interval time, the network bus. When the first field (the address field) is received, the corresponding device decodes next transmitting character. When the interval time is at least 3.5 byte, the message ends.

The whole message frame in RTU mode is a continuous transmitting flow. If there is an interval time (more than 1.5 bytes) before the completion of the frame, the receiving device will renew the uncompleted message and suppose the next byte as the address field of the new message. As such, if the new message follows the previous one within the interval time of 3.5 bytes, the receiving device will deal with it as the same with the previous message. If these two phenomena all happen during the transmission, the CRC will generate a fault message to respond to the sending devices.

The standard structure of RTU frame:

START	T1-T2-T3-T4(transmission time of 3.5 bytes)
ADDR	Communication address: 0-247(decimal system)(0 is the broadcast address)
CMD	03H: read slave parameters 06H: write slave parameters
DATA (N-1) ... DATA (0)	The data of 2*N bytes are the main content of the communication as well as the core of data exchanging
CRC CHK low bit	Detection value: CRC (16BIT)
CRC CHK high bit	
END	T1-T2-T3-T4(transmission time of 3.5 bytes)

9.3.2.2 RTU communication frame error checkout

Various factors (such as electromagnetic interference) may cause error in the data transmission. For example, if the sending message is a logic "1", A-B potential difference on RS485 should be 6V, but in reality, it may be -6V because of electromagnetic interference, and then the other devices take the sent message as logic "0". If there is no error checkout, the receiving devices will not find the message is wrong and they may give incorrect response which cause serious result. So the checkout is essential to the message.

The theme of checkout is that: the sender calculate the sending data according to a fixed formula, and then send the result with the message. When the receiver gets this message, they will calculate another result according to the same method and compare it with the sending one. If two results are the same, the message is correct. If not, the message is incorrect.

The error checkout of the frame can be divided into two parts: the bit checkout of the byte and the whole data checkout of the frame (CRC check).

Bit checkout of the byte

The user can select different bit checkouts or non-checkout, which impacts the check bit setting of each byte.

The definition of even checkout: add an even check bit before the data transmission to illustrate the number of "1" in the data transmission is odd number or even number. When it is even, the check byte is "0", otherwise, the check byte is "1". This method is used to stabilize the parity of the data.

The definition of odd checkout: add an odd check bit before the data transmission to illustrate the number of "1" in the data transmission is odd number or even number. When it is odd, the check byte is "0", otherwise, the check byte is "1". This method is used to stabilize the parity of the data.

For example, when transmitting "11001110", there are five "1" in the data. If the even checkout is applied, the even check bit is "1"; if the odd checkout is applied; the odd check bit is "0". The even and odd check bit is calculated on the check bit position of the frame. And the receiving devices also carry out even and odd checkout. If the parity of the receiving data is different from the setting value, there is an error in the communication.

CRC check

The checkout uses RTU frame format. The frame includes the frame error detection field which is based on the CRC calculation method. The CRC field is two bytes, including 16 figure binary values. It is added into the frame after calculated by transmitting device. The receiving device recalculates the CRC of the received frame and compares them with the value in the received CRC field. If the two CRC values are different, there is an error in the communication.

During CRC, 0*FFFF will be stored. And then, deal with the continuous 6-above bytes in the frame and the value in the register. Only the 8Bit data in every character is effective to CRC, while the start bit, the end and the odd and even check bit is ineffective.

The calculation of CRC applies the international standard CRC checkout principles. When the user is editing CRC calculation, he can refer to the relative standard CRC calculation to write the required CRC calculation program.

Here provided a simple function of CRC calculation for the reference (programmed with C language):

```
unsigned int  crc_cal_value(unsigned char  *data_value,unsigned char
data_length)
{
int i;
unsigned int  crc_value=0xffff;
while(data_length--)
{  crc_value^=*data_value++;
    for(i=0;i<8;i++)
    {
if(crc_value&0x0001)crc_value=(crc_value>>1)^0xa001;
    else crc_value=crc_value>>1;
    }    }
return(crc_value);
}
```

In ladder logic, CKSM calculated the CRC value according to the frame with the table inquiry. The method is advanced with easy program and quick calculation speed. But the ROM space the program occupied is huge. So use it with caution according to the program required space.

9.4 RTU command code and communication data illustration

9.4.1 RTU mode

9.4.1.1 Command code: 03H

read N words (Word) (N≤16)

Command code 03H means that if the master read data from the VFD, the reading number depends on the "data number" in the command code. Max. continuous reading number is 16 and the parameter address should be continuous. The byte length of every data is 2 (one word). The following command format is illustrated by hex (a number with "H" means hex) and one hex occupies one byte.

The command code is used to read the working step of the VFD.

For example, read continuous 2 data content from 0004H from the VFD with the address of 01H (read the content of data address of 0004H and 0005H), the frame structure is as below:

RTU master command message (from the master to the VFD)

START	T1-T2-T3-T4 (transmission time of 3.5 bytes)
ADDR	01H
CMD	03H
High bit of the start address	00H
Low bit of the start address	04H
High bit of data number	00H
Low bit of data number	02H
CRC low bit	85H
CRC high bit	CAH
END	T1-T2-T3-T4 (transmission time of 3.5 bytes)

T1-T2-T3-T4 between START and END is to provide at least the time of 3.5 bytes as the leisure time and distinguish two messages for the avoidance of taking two messages as one message.

ADDR = 01H means the command message is sent to the VFD with the address of 01H and ADDR occupies one byte

CMD=03H means the command message is sent to read data from the VFD and CMD occupies one byte

"Start address" means reading data form the address and it occupies 2 bytes with the fact that the high bit is in the front and the low bit is in the behind.

"Data number" means the reading data number with the unit of word. If the "start address" is 0004H and the "data number" is 0002H, the data of 0004H and 0005H will be read.

CRC occupies 2 bytes with the fact that the high bit is in the front and the low bit is in the behind.

RTU slave response message (from the VFD to the master)

START	T1-T2-T3-T4 (transmission time of 3.5 bytes)
ADDR	01H
CMD	03H
Byte number	04H
Data high bit of address 0004H	13H
Data low bit of address 0004H	88H
Data high bit of address 0005H	00H
Data low bit of address 0005H	00H
CRC CHK low bit	7EH
CRC CHK high bit	9DH
END	T1-T2-T3-T4 (transmission time of 3.5 bytes)

The meaning of the response is that:

ADDR = 01H means the command message is sent to the VFD with the address of 01H and ADDR occupies one byte

CMD=03H means the message is received from the VFD to the master for the response of reading command and CMD occupies one byte

"Byte number" means all byte number from the byte(excluding the byte) to CRC byte(excluding the byte). 04 means there are 4 byte of data from the "byte number" to "CRC CHK low bit", which are "digital address 0004H high bit", "digital address 0004H low bit", "digital address 0005H high bit" and "digital address 0005H low bit".

There are 2 bytes stored in one data with the fact that the high bit is in the front and the low bit is in the behind of the message, the data of data address 0004H is 1388H, and the data of data address 0005H is 0000H.

CRC occupies 2 bytes with the fact that the high bit is in the front and the low bit is in the behind.

9.4.1.2 Command code: 06H

06H (correspond to binary 0000 0110), write one word (Word)

The command means that the master write data to the VFD and one command can write one data other than multiple dates. The effect is to change the working mode of the VFD.

For example, write 5000 (1388H) to 0004H from the VFD with the address of 02H, the frame structure is as below:

RTU master command message (from the master to the VFD)

START	T1-T2-T3-T4(transmission time of 3.5 bytes)
ADDR	02H
CMD	06H
High bit of write data address	00H
Low bit of write data address	04H
High bit of data content	13H
Low bit of data content	88H
CRC CHK low bit	C5H
CRC CHK high bit	6EH
END	T1-T2-T3-T4 (transmission time of 3.5 bytes)

RTU slave response message (from the VFD to the master)

START	T1-T2-T3-T4 (transmission time of 3.5 bytes)
ADDR	02H
CMD	06H
High bit of writing data address	00H
Low bit of writing data address	04H
High bit of data content	13H
Low bit of data content	88H

CRC CHK low bit	C5H
CRC CHK high bit	6EH
END	T1-T2-T3-T4 (transmission time of 3.5 bytes)

Note: section 9.4.1.1 and 9.4.1.2 mainly describe the command format, and the detailed application will be mentioned in 9.6 with examples.

9.4.1.3 Command code 08H for diagnosis

Meaning of sub-function codes

Sub-function Code	Description
0000	Return to inquire information data

For example: The inquiry information string is same as the response information string when the loop detection to address 01H of driver is carried out.

The RTU request command is:

START	T1-T2-T3-T4 (transmission time of 3.5 bytes)
ADDR	01H
CMD	08H
High bit of sub-function code	00H
Low bit of sub-function code	00H
High bit of data content	12H
Low bit of data content	ABH
Low bit of CRC	ADH
High bit of CRC	14H
END	T1-T2-T3-T4 (transmission time of 3.5 bytes)

The RTU response command is:

START	T1-T2-T3-T4 (transmission time of 3.5 bytes)
ADDR	01H
CMD	08H
High bit of sub-function code	00H
Low bit of sub-function code	00H
High bit of data content	12H
Low bit of data content	ABH
Low bit of CRC	ADH
High bit of CRC	14H
END	T1-T2-T3-T4 (transmission time of 3.5 bytes)

9.4.1.4 Command code: 10H, continuous writing

Command code 10H means that if the master writes data to the VFD, the data number depends on the "data number" in the command code. The max. continuous reading number is 16.

For example, write 5000(1388H) to 0004H of the VFD whose slave address is 02H and 50(0032H) to 0005H, the frame structure is as below:

The RTU request command is:

START	T1-T2-T3-T4 (transmission time of 3.5 bytes)
ADDR	02H
CMD	10H
High bit of write data	00H
Low bit of write data	04H
High bit of data number	00H
Low bit of data number	02H
Byte number	04H
High bit of data 0004H	13H
Low bit of data 0004H	88H
High bit of data 0005H	00H
Low bit of data 0005H	32H
Low bit of CRC	C5H
High bit of CRC	6EH
END	T1-T2-T3-T4 (transmission time of 3.5 bytes)

The RTU response command is:

START	T1-T2-T3-T4 (transmission time of 3.5 bytes)
ADDR	02H
CMD	10H
High bit of write data	00H
Low bit of write data	04H
High bit of data number	00H
Low bit of data number	02H
Low bit of CRC	C5H
High bit of CRC	6EH
END	T1-T2-T3-T4 (transmission time of 3.5 bytes)

9.4.2 ASCII mode

9.4.2.1 Command code: 03H (0000 0011), read N words (Word) ($N \leq 16$ words)

For instance: As for the VFD whose slave address is 01H, the starting address of internal storage is 0004, read two words continuously, the structure of this frame is listed as below:

ASCII master command message (the command sent from master to the VFD)		ASCII slave response message (the message sent from VFD to the master)	
START	':'	START	':'
ADDR	'0'	ADDR	'0'
	'1'		'1'
CMD	'0'	CMD	'0'
	'3'		'3'
High bit of starting address	'0'	Byte number	'0'
	'0'		'4'
Low bit of starting address	'0'	High bit of data address	'1'
	'4'	0004H	'3'
High bit of data number	'0'	Low bit of data address	'8'
	'0'	0004H	'8'
Low bit of data number	'0'	High bit of data address	'0'
	'2'	0005H	'0'
LRC CHK Hi	'F'	Low bit of data address	'0'
LRC CHK Lo	'6'	0005H	'0'
END Hi	CR	LRC CHK Hi	'5'
END Lo	LF	LRC CHK Lo	'D'
		END Hi	CR
		END Lo	LF

9.4.2.2 Command code: 06H (0000 0110), write one word (Word)

For instance: Write 5000 (1388H) to the 0004H address of the VFD whose slave address is 02H, then the structure of this frame is listed as below:

ASCII master command message (the command sent by the master to the VFD)		ASCII slave response message (the message sent by the VFD to the master)	
START	':'	START	':'
ADDR	'0'	ADDR	'0'
	'2'		'2'
CMD	'0'	CMD	'0'
	'6'		'6'
High bit of write data	'0'	High bit of write data	'0'
	'0'		'0'

ASCII master command message (the command sent by the master to the VFD)		ASCII slave response message (the message sent by the VFD to the master)	
Low bit of write data	'0'	Low bit of write data	'0'
	'4'		'4'
High bit of data content	'1'	High bit of data content	'1'
	'3'		'3'
Low bit of data content	'8'	Low bit of data content	'8'
	'8'		'8'
LRC CHK Hi	'5'	LRC CHK Hi	'5'
LRC CHK Lo	'9'	LRC CHK Lo	'9'
END Hi	CR	END Hi	CR
END Lo	LF	END Lo	LF

9.4.2.3 Command code: 08H (0000 1000), diagnose function

Meaning of sub function code:

Sub function code	Instruction
0000	Return inquiry message data

For instance: carry out circuit detection on drive address 01H, the content of inquiry message word string is the same with response message word string, its format is listed as below:

ASCII master command message (the command sent by the master to the VFD)		ASCII slave response message (the message sent by the VFD to the master)	
START	‘.’	START	‘.’
ADDR	'0'	ADDR	'0'
	'1'		'1'
CMD	'0'	CMD	'0'
	'8'		'8'
High bit of write data address	'0'	High bit of write data address	'0'
	'0'		'0'
Low bit of write data address	'0'	Low bit of write data address	'0'
	'0'		'0'
High bit of data content	'1'	High bit of data content	'1'
	'2'		'2'
Low bit of data content	'A'	Low bit of data content	'A'
	'B'		'B'
LRC CHK Hi	'3'	LRC CHK Hi	'3'
LRC CHK Lo	'A'	LRC CHK Lo	'A'
END Hi	CR	END Hi	CR
END Lo	LF	END Lo	LF

9.4.2.4 Command code: 10H, continuous writing function

Command code 10H means the master write data to the VFD, the number of data being written is determined by the command "data number", the max. number of continuous writing is 16 words.

For instance: Write 5000 (1388H) to 0004H of the VFD whose slave address is 02H, write 50 (0032H) to 0005H of the VFD whose slave address is 02H, then the structure of this frame is listed as below:

ASCII master command message (the command sent by the master to the VFD)		ASCII slave response message (the message sent by the VFD to the master)	
START	':'	START	':'
ADDR	'0'	ADDR	'0'
	'2'		'2'
CMD	'1'	CMD	'1'
	'0'		'0'
High bit of starting address	'0'	High bit of starting address	'0'
	'0'		'0'
Low bit of starting address	'0'	Low bit of starting address	'0'
	'4'		'4'
High bit of data number	'0'	High bit of data number	'0'
	'0'		'0'
Low bit of data number	'0'	Low bit of data number	'0'
	'2'		'2'
Byte number	'0'	LRC CHK Hi	'E'
	'4'	LRC CHK Lo	'8'
High bit of data 0004H content	'1'	END Hi	CR
	'3'	END Lo	LF
Low bit of data 0004H content	'8'		
	'8'		
High bit of data 0005H content	'0'		
	'0'		
Low bit of data 0005H content	'3'		
	'2'		
LRC CHK Hi	'1'		
LRC CHK Lo	'7'		
END Hi	CR		
END Lo	LF		

9.5 The definition of data address

The address definition of the communication data in this part is to control the running of the VFD and get the state information and relative function parameters of the VFD.

9.5.1 The rules of parameter address of the function codes

The parameter address occupies 2 bytes with the fact that the high bit is in the front and the low bit is in the behind. The range of high and low byte are: high byte—00 - ffH; low byte—00 - ffH. The high byte is the group number before the radix point of the function code and the low byte is the number after the radix point. But both the high byte and the low byte should be changed into hex. For example P05.06, the group number before the radix point of the function code is 05, then the high bit of the parameter is 05, the number after the radix point 05, then the low bit of the parameter is 06, then the function code address is 0506H and the parameter address of P10.01 is 0A01H.

Function code	Name	Parameter description	Default value	Modify
P10.00	Simple PLC means	0: Stop after running once. 1: Run at the final value after running once. 2: Cycle running.	0	<input type="radio"/>
P10.01	Simple PLC memory selection	0: Power loss without memory 1: Power loss: PLC record the running stage and frequency when power loss.	0	<input type="radio"/>

Note: P29 group is the factory parameter which cannot be read or changed. Some parameters cannot be changed when the VFD is in the running state and some parameters cannot be changed in any state. The setting range, unit and relative instructions should be paid attention to when modifying the function code parameters.

Besides, EEPROM is stocked frequently, which may shorten the usage time of EEPROM. For users, some functions are not necessary to be stocked on the communication mode. The needs can be met on by changing the value in RAM. Changing the high bit of the function code form 0 to 1 can also realize the function. For example, the function code P00.07 is not stocked into EEPROM. Only by changing the value in RAM can set the address to 8007H. This address can only be used in writing RAM other than reading. If it is used to read, it is an invalid address.

9.5.2 The address instruction of other function in MODBUS

The master can operate on the parameters of the VFD as well as control the VFD, such as running or stopping and monitoring the working state of the VFD.

The following table shows the parameter list of other functions:

Function instruction	Address definition	Data meaning instruction	R/W characteristics
Communication control command	2000H	0001H: forward running	R/W
		0002H: reverse running	
		0003H: forward jogging	
		0004H: reverse jogging	
		0005H: stop	
		0006H: coast to stop	
		0007H: fault reset	
		0008H: jogging stop	

Function instruction	Address definition	Data meaning instruction	R/W characteristics
The address of the communication n setting value	2001H	Communication setting frequency (0–Fmax (unit: 0.01Hz))	R/W
	2002H	PID reference, range (0 - 1000, 1000 corresponds to 100.0%)	
	2003H	PID feedback, range (0 - 1000, 1000 corresponds to 100.0%)	R/W
	2004H	Torque setting value (-3000–3000, 1000 corresponds to the 100.0% of the rated current of the motor)	R/W
	2005H	The upper limit frequency setting during forward rotation (0–Fmax (unit: 0.01Hz))	R/W
	2006H	The upper limit frequency setting during reverse rotation (0–Fmax (unit: 0.01Hz))	R/W
	2007H	The upper limit torque of electromotion torque (0–3000, 1000 corresponds to the 100.0% of the rated current of the motor)	R/W
	2008H	The upper limit torque of braking torque (0–3000, 1000 corresponds to the 100.0% of the rated current of the motor)	R/W
	2009H	Special control command word Bit0–1: =00: motor 1 =01: motor 2 =10: motor 3 =11: motor 4 Bit2: =1 torque control =0: speed control	R/W
	200AH	Virtual input terminal command , range: 0x00–0x1FF	R/W
	200BH	Virtual output terminal command , range: 0x00–0x0F	R/W
	200CH	Voltage setting value(special for V/F separation) (0–1000, 1000 corresponds to the 100.0% of the rated voltage of the motor)	R/W
200DH	AO output setting 1 (-1000–1000, 1000 corresponds to 100.0%)	R/W	
200EH	AO output setting 2(-1000–1000, 1000 corresponds to 100.0%)	R/W	
SW 1 of the VFD	2100H	0001H: forward running 0002H: forward running 0003H: stop	R

Function instruction	Address definition	Data meaning instruction	R/W characteristics
		0004H: fault	
		0005H: POFF state	
SW 2 of the VFD	2101H	Bit0: =0: bus voltage is not established =1: bus voltage is established Bi1-2: =00: motor 1 =01: motor 2 =10: motor 3 =11: motor 4 Bit3: =0: asynchronous motor =1: synchronous motor Bit4: =0: pre-alarm without overload =1: overload pre-alarm Bit5- Bit6: =00: keypad control =01: terminal control =10: communication control	R
Fault code of the VFD	2102H	See the fault type instruction	R
Identifying code of the VFD	2103H	GD200A ----0x0107	R
Operation frequency	3000H	Range: 0.00Hz-P00.03	R
Setting frequency	3001H	Range: 0.00Hz-P00.03	R
Bus voltage	3002H	Range: 0-1200V	R
Output voltage	3003H	Range: 0-1200V	R
Output current	3004H	Range: 0.0-5000.0A	R
Operation speed	3005H	Range: 0-65535RPM	R
Output power	3006H	Range: -300.0-300.0%	R
Output torque	3007H	Range: 0-65535RPM	R
Close loop setting	3008H	Range: -100.0% - 100.0%	R
Close loop feedback	3009H	Range: -100.0% - 100.0%	R
Input IO state	300AH	Range: 0000-00FF	R
Output IO state	300BH	Range: 0000-00FF	R
AI 1	300CH	Range: 0.00-10.00V	R
AI 2	300DH	Range: 0.00-10.00V	R
AI 3	300EH	Range: 0.00-10.00V	R
AI 4	300FH	Reserved	R
Read high speed pulse 1 input	3010H	Range: 0.00-50.00kHz	R

Function instruction	Address definition	Data meaning instruction	R/W characteristics
Read high speed pulse 2 input	3011H	Reserved	R
Read current step of multi-step speed	3012H	Range: 0–15	R
External length	3013H	Range: 0–65535	R
External counting value	3014H	Range: 0–65535	R
Torque setting	3015H	Range: 0–65535	R
VFD code	3016H		R
Fault code	5000H		R

R/W characteristics means the function is with read and write characteristics. For example, "communication control command" is writing characteristics and control the VFD with writing command (06H). R characteristic can only read other than write and W characteristic can only write other than read.

Note: when operate on the VFD with the table above, it is necessary to enable some parameters. For example, the operation of running and stopping, it is necessary to set P00.01 to communication running command channel and set P00.02 to MODBUS communication channel. And when operate on "PID reference", it is necessary to set P09.00 to "MODBUS communication setting".

The encoding rules for device codes (corresponds to identifying code 2103H of the VFD)

Code high 8 bit	Meaning	Code low 8 bit	Meaning
0x01	GD	0x07	GD200A general VFDs

Note: The code is consisted of 16 bits including high 8 bits and low 8 bits. High 8 bits mean the motor type series and low 8 bits mean the derived motor types of the series.

9.5.3 Fieldbus ratio values

The communication data is expressed by hex in actual application and there is no radix point in hex. For example, 50.12Hz cannot be expressed by hex so 50.12 can be magnified by 100 times into 5012, so hex 1394H can be used to express 50.12.

A non-integer can be timed by a multiple to get an integer and the integer can be called fieldbus ratio values.

The fieldbus ratio values are referred to the radix point of the setting range or default value in the function parameter list. If there are figures behind the radix point ($n=1$), then the fieldbus ratio value m is 10^n . Take the table as the example:

Function code	Name	Details	Default value	Modify
P01.20	Wake-up from sleep delay time	0.0–3600.0s (valid when P01.19=2)	0.0s	○

If there is one figure behind the radix point in the setting range or the default value, then the fieldbus ratio value is 10. If the data received by the upper monitor is 50, then the "hibernation restore delay time" is 5.0 ($5.0=50\div 10$).

If MODBUS communication is used to control the hibernation restore delay time as 5.0s. Firstly, 5.0 can be magnified by 10 times to integer 50 (32H) and then this data can be sent.

01 06 01 14 00 32 49 E7
 VFD Write Parameters Data CRC
 address command address number check

After the VFD receives the command, it will change 50 into 5 according to the fieldbus ratio value and then set the hibernation restore delay time as 5s.

Another example, after the upper monitor sends the command of reading the parameter of hibernation restore delay time, if the response message of the VFD is as following:

01 03 02 00 32 39 91
 VFD Read 2-byte Parameters CRC check
 address command data data

Because the parameter data is 0032H (50) and 50 divided by 10 is 5, then the hibernation restore delay time is 5s.

9.5.4 Fault message response

There may be fault in the communication control. For example, some parameter can only be read. If a writing message is sent, the VFD will return a fault response message.

The fault message is from the VFD to the master, its code and meaning is as follows:

Code	Name	Meaning
01H	Illegal command	The command from master cannot be executed. The reason maybe: 1. This command is only for new version and this version cannot realize. 2. Slave is in fault state and cannot execute it.
02H	Illegal data address.	Some of the operation addresses are invalid or not allowed to access. Especially the combination of the register and the transmitting bytes are invalid.
03H	Illegal value	When there are invalid data in the message framed received by slave. Note: This error code does not indicate the data value to write exceed the range, but indicate the message frame is an illegal frame.

Code	Name	Meaning
04H	Operation failure	The parameter setting in parameter writing is invalid. For example, the function input terminal cannot be set repeatedly.
05H	Password error	The password written to the password check address is not same as the password set by P07.00.
06H	Data frame error	In the frame message sent by the upper monitor, the length of the digital frame is incorrect or the counting of CRC check bit in RTU is different from the lower monitor.
07H	Parameter read-only	It only happen in write command, the reason maybe: 1. The written data exceeds the parameter range. 2. The parameter should not be modified now. 3. The terminal has already been used.
08H	The parameter cannot be changed during running	The modified parameter in the writing of the upper monitor cannot be modified during running.
09H	Password protection	When the upper monitor is writing or reading and the user password is set without password unlocking, it will report that the system is locked.

The slave uses functional code fields and fault addresses to indicate it is a normal response or some error occurs (named as objection response). For normal responses, the slave shows corresponding function codes, digital address or sub-function codes as the response. For objection responses, the slave returns a code which equals the normal code, but the first byte is logic 1.

For example: when the master sends a message to the slave, requiring it to read a group of address data of the VFD function codes, there will be following function codes:

0 0 0 0 0 1 1 (Hex 03H)

For normal responses, the slave responds the same codes, while for objection responses, it will return:

1 0 0 0 0 1 1 (Hex 83H)

Besides the function codes modification for the objection fault, the slave will respond a byte of abnormal code which defines the error reason.

When the master receives the response for the objection, in a typical processing, it will send the message again or modify the corresponding order.

For example, set the "running command channel" of the VFD (P00.01, parameter address is 0001H) with the address of 01H to 03, the command is as following:

<u>01</u>	<u>06</u>	<u>00 01</u>	<u>00 03</u>	<u>98 0B</u>
VFD address	Write command	Parameters address	Parameters data	CRC check

But the setting range of "running command channel" is 0–2, if it is set to 3, because the number is beyond the range, the VFD will return fault response message as below:

<u>01</u>	<u>86</u>	<u>04</u>	<u>43 A3</u>
VFD address	Abnormal response code	Fault code	CRC check

Abnormal response code 86H means the abnormal response to writing command 06H; the fault code is 04H. In the table above, its name is operation failed and its meaning is that the parameter setting in parameter writing is invalid. For example, the function input terminal cannot be set repeatedly.

9.6 Example of writing and reading

Refer to 9.4 for the command format.

9.6.1 Example of reading command 03H

Read the state word 1 of the VFD with the address of 01H (refer to the parameter list in 9.5.2). From the table 1, the parameter address of the state word 1 of the VFD is 2100H.

RTU mode:

The command sent to the VFD:

<u>01</u>	<u>03</u>	<u>21 00</u>	<u>00 01</u>	<u>8E 36</u>
VFD address	Read command	Parameters address	Data number	CRC check

The response message may be as follows:

<u>01</u>	<u>03</u>	<u>02</u>	<u>00 03</u>	<u>F8 45</u>
VFD address	Read command	Data address	Data content	CRC check

ASCII mode:

The command sent to the VFD:

:	<u>01</u>	<u>03</u>	<u>21 00</u>	<u>00 01</u>	<u>DA</u>	<u>CR LF</u>
START	VFD address	Read command	Parameters address	Data number	LRC check	END

If the operation is successful, the response may be as follows:

 : 01 03 02 00 03 F7 CR LF
 START VFD Read Byte Data LRC END
 address command number content check

The data content is 0003H, which indicates the VFD is in the stopped state.

9.6.2 Example of writing command 06H

Example 1: make the VFD with the address of 03H to run forward. Refer to the table of other function parameters, the address of "communication control command" is 2000H and forward running is 0001. See the following table.

Function instruction	Address definition	Data meaning instruction	R/W characteristics
Communication control command	2000H	0001H: forward running	R/W
		0002H: reverse running	
		0003H: forward jogging	
		0004H: reverse jogging	
		0005H: stop	
		0006H: coast to stop	
		0007H: fault reset	
		0008H: jogging stop	

RTU mode:

The command sent by the master:

03 06 20 00 00 01 42 28
 VFD Write Parameters Forward CRC
 address command address running check

If the operation is successful, the response may be as follows (the same with the command sent by the master):

03 06 20 00 00 01 42 28
 VFD Write Parameters Forward CRC
 address command address running check

ASCII mode:

The command sent to the VFD:

: 01 06 20 00 00 01 D6 CR LF
 START VFD Write Parameters Data LRC END
 address command address number check

If the operation is successful, the response may be as follows (the same with the command sent by the master):

: 01 06 20 00 00 01 D6 CR LF
 START VFD Write Parameters Data LRC END
 address command address number check

Example 2: set the max. output frequency of the VFD with the address of 03H as 100Hz.

Function code	Name	Details	Setting range	Default value	Modify
P00.03	Max output frequency	P00.04–600.00Hz (400.00Hz)	10.00–600.00	50.00Hz	⊙

See the figures behind the radix point, the fieldbus ratio value of the max. output frequency (P00.03) is 100. 100Hz timed by 100 is 10000 and the corresponding hex is 2710H.

RTU mode:

The command sent by the master:

03 06 00 03 27 10 62 14
 VFD Write Parameters Parameter CRC check
 address command address data

If the operation is successful, the response may be as below (the same with the command sent by the master):

03 06 00 03 27 10 62 14
 VFD Write Parameters Parameter CRC check
 address command address data

ASCII mode:

The command sent to the VFD:

: 03 06 00 03 27 10 BD CR LF
 START VFD Write Parameters Data LRC END
 address command address number check

If the operation is successful, the response may be as follows (the same with the command sent by the master):

: 03 06 00 03 27 10 BD CR LF
 START VFD Write Parameters Data LRC END
 address command address number check

9.6.3 Example of continuous writing command 10H

Example 1: make the VFD whose address is 01H run forward at 10Hz. Refer to the instruction of 2000H and 0001. Set the address of "communication setting frequency" is 2001H and 10Hz corresponds to 03E8H. See the table below.

Function instruction	Address definition	Data meaning instruction	R/W characteristics
Communication control command	2000H	0001H: forward running	R/W
		0002H: reverse running	
		0003H: forward jogging	
		0004H: reverse jogging	
		0005H: stop	
		0006H: coast to stop	
		0007H: fault reset	
		0008H: jogging stop	
The address of communication setting	2001H	Communication setting frequency(0–Fmax(unit: 0.01Hz))	R/W
	2002H	PID given, range(0–1000, 1000 corresponds to100.0%)	

RTU mode:

The command sent to the VFD:

01 10 20 00 00 02 04 00 01 03 E8 3B 10
 VFD Continuous Parameters Data Byte Forward 10Hz CRC
 address writing address number number running check

If the operation is successful, the response may be as follows:

01 10 20 00 00 02 4A 08
 VFD Continuous Parameters Data CRC
 address writing address number check
 command

ASCII mode:

The command sent to the VFD:

: 01 10 20 00 00 02 04 00 01 03 E8 BD CR LF
 START VFD Continuous Parameters Data Byte Forward 10Hz LRC END
 address writing address number number running check

If the operation is successful, the response may be as follows:

: 01 10 20 00 00 02 CD CR LF
 START VFD Continuous Parameters Data LRC END
 address writing address number check

Example 2: set the ACC time of 01H VFD as 10s and the DEC time as 20s

Function code	Name	Parameter description	Default value	Modify
P00.11	Acceleration time 1	Setting range of P00.11 and P00.12: 0.0–3600.0s	Model depended	<input type="radio"/>
P00.12	Deceleration time 1			<input type="radio"/>

The corresponding address of P00.11 is 000B, the ACC time of 10s corresponds to 0064H, and the DEC time of 20s corresponds to 00C8H.

RTU mode:

The command sent to the VFD:

01 10 00 0B 00 02 04 00 64 00 C8 F2 55
VFD Continuous Parameters Data Byte 10s 20s CRC check
address writing address number number

If the operation is successful, the response may be as follows:

01 10 00 0B 00 02 30 0A
VFD Continuous Parameters Data CRC check
address writing address number

ASCII mode:

The command sent to the VFD:

: 01 10 00 0B 00 02 04 00 64 00 C8 B2 CR LF
START VFD Continuous Parameters Data 10s 20s LRC END
address writing address number number check

If the operation is successful, the response may be as follows:

: 01 10 00 0B 00 02 E2 CR LF
START VFD Continuous Parameters Data LRC END
address writing address number number check

Note: The blank in the above command is for illustration. The blank cannot be added in the actual application unless the upper monitor can remove the blank by themselves.

Appendix A Technical data

A.1 What this chapter contains

This chapter contains the technical specifications of the VFD, as well as provisions for fulfilling the requirements for CE and other marks.

A.2 Ratings

A.2.1 Capacity

VFD sizing is based on the rated motor current and power. To achieve the rated motor power reference in the table, the rated current of the VFD must be higher than or equal to the rated motor current. Also the rated power of the VFD must be higher than or equal to the rated motor power. The power ratings are the same regardless of the supply voltage within one voltage range.

Note:

1. The maximum allowed motor shaft power is limited to 1.5 times of the rated power of the motor. If the limit is exceeded, motor torque and current are automatically restricted. The function protects the input bridge of the drive against overload.
2. The ratings apply at ambient temperature of 40 °C
3. It is important to check that in Common DC systems the power flowing through the common DC connection does not exceed the rated power of the motor.

A.2.2 Derating

The load capacity decreases if the installation site ambient temperature exceeds 40 °C, the altitude exceeds 1000 meters or the switching frequency is changed from 4 kHz to 8, 12 or 15 kHz.

A.2.2.1 Temperature derating

In the temperature range +40 °C—+50 °C, the rated output current is decreased by 1% for every additional 1 °C. Refer to the below list for the actual derating.

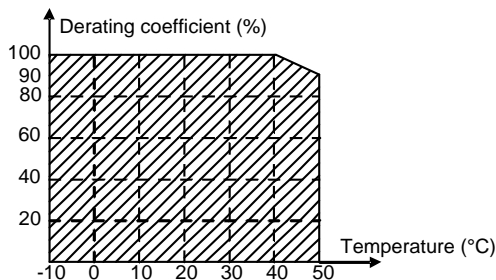

A.2.2.2 Altitude derating

The device can output rated power if the installation site below 1000m. The output power decreases if the altitude exceeds 1000 meters. When the installation site altitude exceeds 1000m, derate 1% for every increase of 100m; when the installation site altitude exceeds 3000m, consult the local INVT dealer or office.

A.2.2.3 Carrier frequency derating

For Goodrive200A series VFDs, different power level corresponds to different carrier frequency range. The rated power of the VFD is based on the factory carrier frequency, so if it is above the factory value, the VFD needs to derate 10% for every additional 1 kHz carrier frequency.

A.3 Electric power network specification

Voltage	AC 3PH 380(-15%)–440(+10%)
Short-circuit capacity	Maximum allowed prospective short-circuit current at the input power connection as defined in IEC 60439-1 is 100 kA. The drive is suitable for use in a circuit capable of delivering not more than 100 kA at the drive maximum rated voltage.
Frequency	50/60 Hz \pm 5%, maximum rate of change 20%/s

A.4 Motor connection data

Motor type	Asynchronous inductance motor
Voltage	0 to U ₁ , 3-phase symmetrical, U _{max} at the field weakening point
Short-circuit protection	The motor output is short-circuit proof by IEC 61800-5-1
Frequency	0–400 Hz
Frequency resolution	0.01 Hz
Current	Refer to Rated specifications
Power limit	1.5 times of the rated power of the motor
Field weakening point	10–400 Hz
Carrier frequency	4, 8, 12 or 15 kHz

A.4.1 EMC compatibility and motor cable length

To comply with the European EMC Directive (2004/108/EC), use the following maximum motor cable lengths for 4 kHz carrier frequency.

All models (with external EMC filters)	Maximum motor cable length (m)
Environment category II (category C3)	30

Maximum motor cable length is determined by the drive's operational factors. Contact your local INVT representative for the exact maximum lengths when using external EMC filters.

A.5 Applicable standards

The VFD complies with the following standards:

EN ISO 13849-1	Safety of machinery-safety related parts of control systems - Part 1: general principles for design
IEC/EN 60204-1	Safety of machinery. Electrical equipment of machines. Part 1: General requirements.
IEC/EN 62061	Safety of machinery – Functional safety of safety-related electrical, electronic and programmable electronic control systems
IEC/EN 61800-3	Adjustable speed electrical power drives systems. Part 3: EMC requirements and specific test methods
IEC/EN 61800-5-1	Adjustable speed electrical power drive systems – Part 5-1: Safety requirements – Electrical, thermal and energy
IEC/EN 61800-5-2	Adjustable speed electrical power drive systems – Part 5-2: Safety requirements. Functional.
GB/T 30844.1	General-purpose variable-frequency adjustable-speed equipment of 1 kV and lower—Part 1: Technical conditions
GB/T 30844.2	General-purpose variable-frequency adjustable-speed equipment of 1 kV and lower—Part 2: Test methods
GB/T 30844.3	General-purpose variable-frequency adjustable-speed equipment of 1 kV and lower—Part 3: Safety regulations

A.5.1 CE marking

The CE mark is attached to the drive to verify that the drive follows the provisions of the European Low Voltage (2014/35/EU) and EMC Directives (2014/30/EU).

A.5.2 Compliance with the European EMC Directive

The EMC Directive defines the requirements for immunity and emissions of electrical equipment used within the European Union. The EMC product standard (EN 61800-3) covers requirements stated for drives. See section EMC regulations.

A.6 EMC regulations

EMC product standard (EN 61800-3) contains the EMC requirements to the VFD.

First environment: domestic environment (includes establishments connected to a low-voltage network which supplies buildings used for domestic purposes).

Second environment includes establishments connected to a network not directly supplying domestic premises.

Four categories of the VFD:

VFD of category C1: VFD of rated voltage less than 1000 V and used in the first environment.

VFD of category C2: VFD of rated voltage less than 1000 V other than pins, sockets and motion devices and intended to be installed and commissioned only by a professional electrician when used in the first environment.

Note:

IEC/EN 61800-3 in EMC standard doesn't limit the power distribution of the VFD, but it defines the step, installation and commission. The professional electrician has necessary skills in installing and/or commissioning power drive systems, including their EMC aspects.

VFD of category C3: VFD of rated voltage less than 1000 V and used in the second environment other than the first one.

VFD of category C4: VFD of rated voltage more than 1000 V or the rated current is above or equal to 400A and used in the complicated system in second environment.

A.6.1 Category C2

The emission limits are complied with the following provisions:

1. The optional EMC filter is selected according to the options and installed as specified in the EMC filter manual.
2. The motor and control cables are selected as specified in this manual.
3. The drive is installed according to the instructions reference in this manual.
4. For the maximum motor cable length, see EMC compatibility and motor cable length.



- This product may cause radio interference, in which case supplementary mitigation measures may be required.

A.6.2 Category C3

The immunity performance of the drive complies with the demands of IEC/EN 61800-3, second environment.

The emission limits are complied with the following provisions:

1. The optional EMC filter is selected according to the options and installed as specified in the EMC filter manual.
2. The motor and control cables are selected as specified in this manual.
3. The drive is installed according to the instructions reference in this manual.
4. For the maximum motor cable length, see EMC compatibility and motor cable length.



- A drive of category C3 is not intended to be used on a low-voltage public network which supplies domestic premises. Radio frequency interference is expected if the drive is used on such a network.

Appendix B Dimension drawings

B.1 What this chapter contains

Dimension drawings of the Goodrive200A are shown below. The dimensions are reference in millimeters.

B.2 Keypad structure

B.2.1 Structure chart

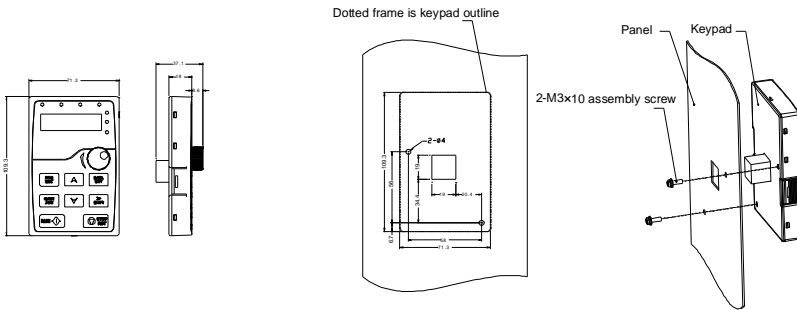

Hole dimension and diagram for keypad installation without bracket

B.2.2 Installation chart

Note: The external keypad can be fixed by M3 screws directly or the installation bracket. The installation bracket for the 0R7G–030G/037P models is optional and the installation bracket for the 037G/045P–500G models is optional or substitutive by the external standard one.

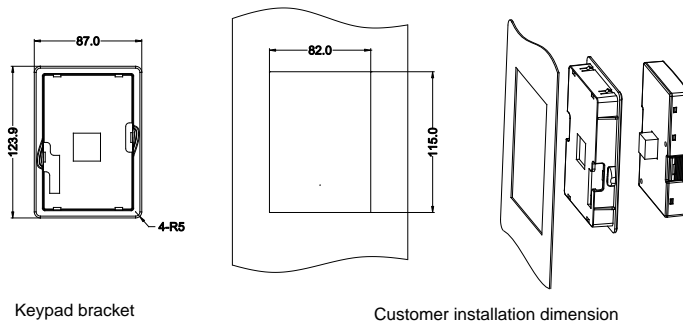

Keypad bracket

Customer installation dimension

Figure B-1 Keypad Installation bracket (optional)

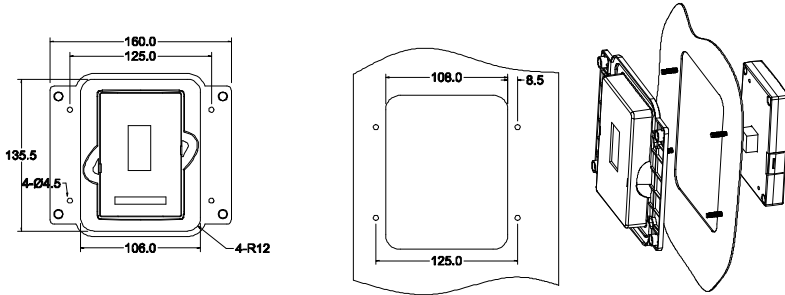

Figure B-2 KeyPAD Installation bracket (standard configuration) for the 037G/045P-500G models

B.3 VFD chart

B.3.1 Wall mounting

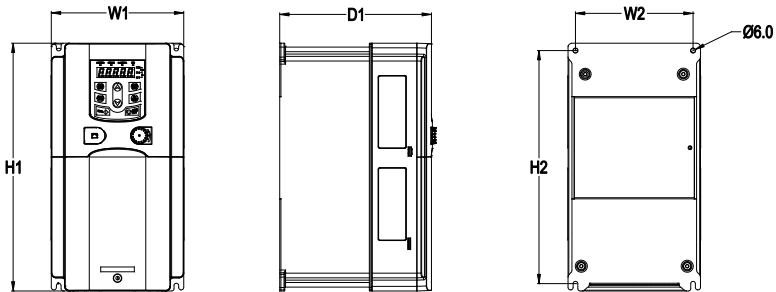

Figure B-3 Wall mounting for the 0R7G-015G/018P models

VFD model	W1	W2	H1	H2	D1	Installation hole diameter	Weight (kg)
0R7G-2R2G	126	115	186	175	155	ø5	1.9
004G/5R5P-5R5G/7R5P	146	131	256	243.5	171	ø6	3.2
7R5G/011P-015G/018P	170	151	320	303.5	199.6	ø6	5.9

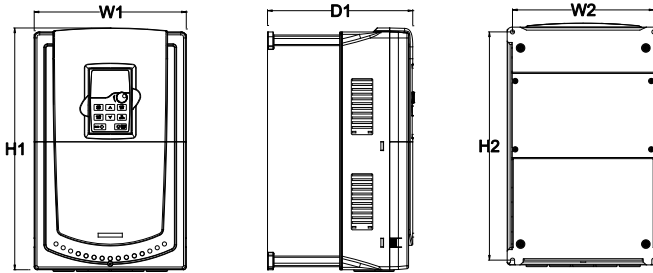

Figure B-4 Wall mounting for the 018G/022P-030G/037P models

VFD model	W1	W2	H1	H2	D1	Installation hole diameter	Weight (kg)
018G/022P	230	210	342	311	219.4	∅6	7.6
022G/030P-030G/037P	255	237	407	384	245.6	∅7	13

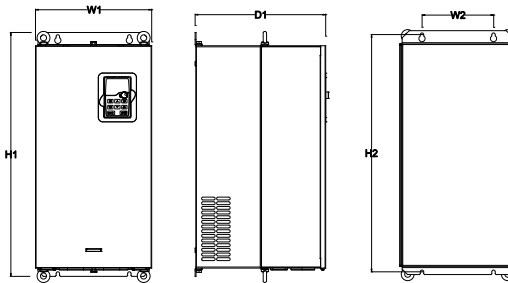

Figure B-5 Wall mounting for the 037G/045P-110G/132P models

VFD model	W1	W2	H1	H2	D1	Installation hole diameter	Weight (kg)
037G/045P-055G/075P	270	130	555	540	332.6	∅7	30
075G/090P-110G/132P	325	200	680	661	373.6	∅9.5	47

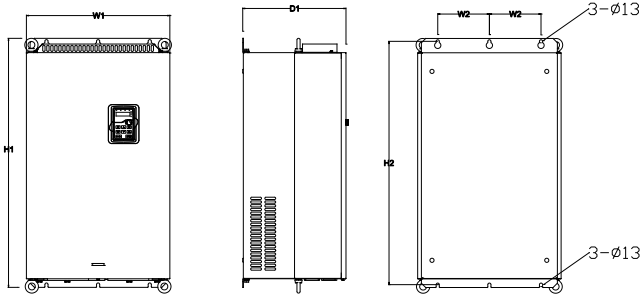

Figure B-6 Wall mounting for the 132G/160P-200G/220P models

VFD model	W1	W2	H1	H2	D1	Installation hole diameter	Weight (kg)
132G/160P-200G/220P	500	180	870	850	368.4	φ11	85

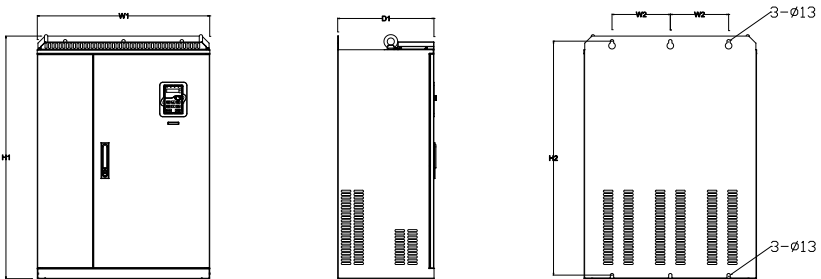

Figure B-7 Wall mounting for the 220G/250P-315G/355P models

VFD model	W1	W2	H1	H2	D1	Installation hole diameter	Weight (kg)
220G/250P-315G/355P	680	230	960	926	387.9	φ13	135

B.3.2 Flange mounting

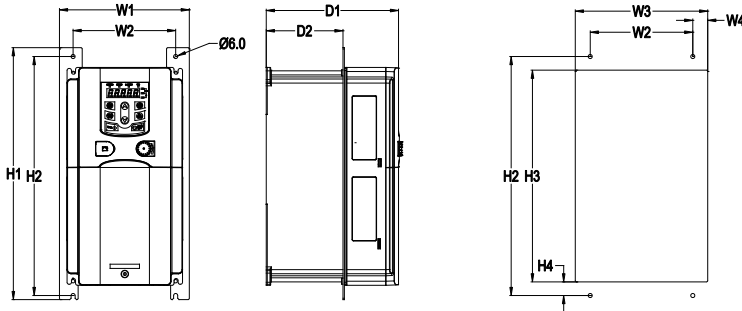

Figure B-8 Flange mounting for the 0R7G–015G/018P models

VFD model	W1	W2	W3	W4	H1	H2	H3	H4	D1	D2	Installation hole diameter	Weight (kg)
0R7G–2R2G	150.2	115	130	7.5	234	220	190	13.5	155	65.5	ø5	1.9
004G/5R5P–5R5G/7R5P	170.2	131	150	9.5	292	276	260	6	171	84.5	ø6	3.2
7R5G/011P–015G/018P	191.2	151	174	11.5	370	351	324	12	199.6	113	ø6	5.9

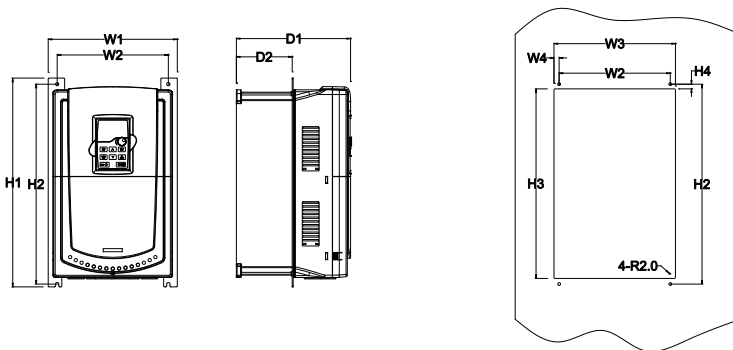

Figure B-9 Flange mounting for the 018G/022P–030G/037P models

VFD model	W1	W2	W3	W4	H1	H2	H3	H4	D1	D2	Installation hole diameter	Weight (kg)
018G/022P	250	210	234	12	375	356	334	10	219.4	108	ø6	7.6
022G/030P–030G/037P	275	237	259	11	445	426	404	10	245.6	119	ø7	13

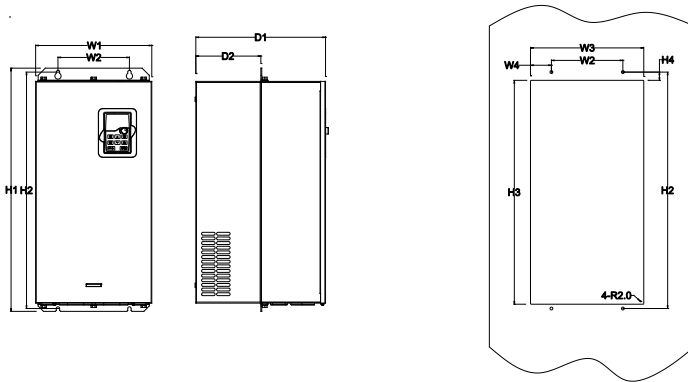

Figure B-10 Flange mounting for the 037G/045P-110G/132P models

VFD model	W1	W2	W3	W4	H1	H2	H3	H4	D1	D2	Installation hole diameter	Weight (kg)
037G/045P-055G/075P	270	130	261	65.5	555	540	516	17	332.6	167	∅7	30
075G/090P-110G/132P	325	200	317	58.5	680	661	626	23	373.6	182	∅9.5	47

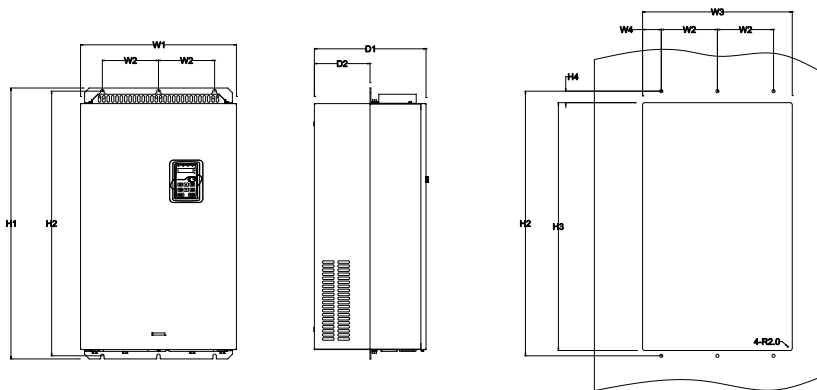

Figure B-11 Flange mounting for the 132G/160P-200G/220P models

VFD model	W1	W2	W3	W4	H1	H2	H3	H4	D1	D2	Installation hole diameter	Weight (kg)
132G/160P-200G/220P	500	180	480	60	870	850	796	37	368.4	178.5	∅11	85

B.3.3 Floor mounting

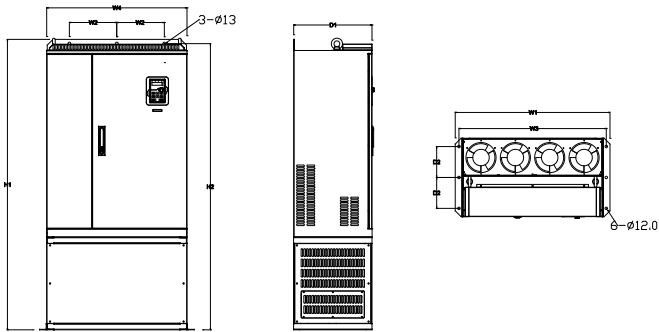

Figure B-12 Floor mounting for the 220G/250P-315G/355P models

VFD model	W1	W2	W3	W4	H1	H2	D1	D2	Installation hole diameter	Weight (kg)
220G/250P-315G/355P	750	230	714	680	1410	1390	380	150	φ13/12	135

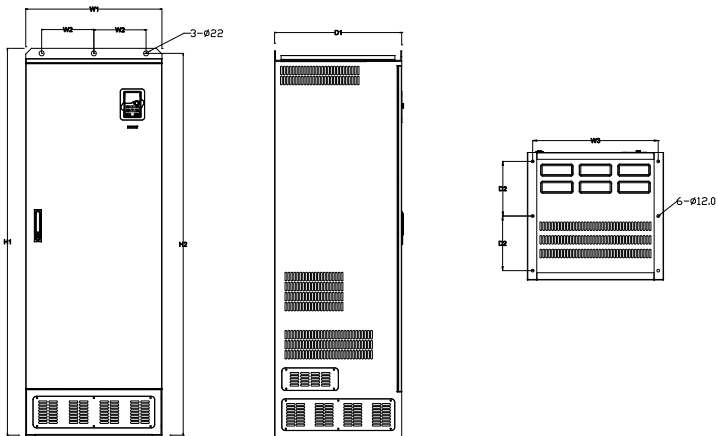

Figure B-13 Floor mounting for the 355G/400P-500G models

VFD model	W1	W2	W3	W4	H1	H2	D1	D2	Installation hole diameter	Weight (kg)
355G/400P-500G	620	230	573	\	1700	1678	560	240	φ22/12	410

Appendix C Peripheral options and parts

C.1 What this chapter contains

This chapter describes how to select the options and parts of Goodrive200A series.

C.2 Peripheral wiring



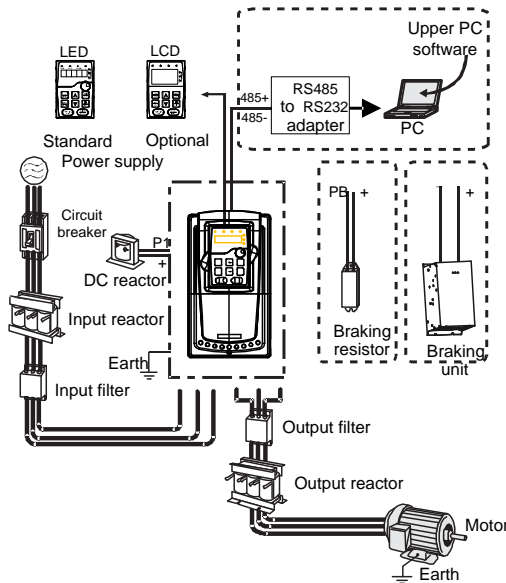





Below is the peripheral wiring of Goodrive200A series VFDs.

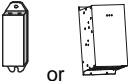

Note:

1. The 015G/018P and lower models have standard film keypad and the 018G/022P and higher models have standard LED keypad.
2. The 030G/037P and lower models are embedded with braking unit.
3. Only the 037G/045P and higher models have P1 terminal and are connected with DC reactors.
4. The braking units apply standard braking unit DBU series in. Refer to the instruction of DBU for detailed information.

Pictures	Name	Descriptions
	Cables	Device to transfer the electronic signals

Pictures	Name	Descriptions
	Breaker	Prevent from electric shock and protect the power supply and the cables system from overcurrent when short circuits occur. (Please select the breaker with the function of reducing high order harmonic and the rated sensitive current to 1 VFD should be above 30mA).
	Input reactor	This device is used to improve the power factor of the input side of the VFD and control the higher harmonic current.
	DC reactor	The 037G/045P and higher models can be connected with DC reactor.
	Input filter	Control the electromagnetic interference generated from the VFD, please install close to the input terminal side of the VFD.
 or 	Braking unit or resistors	Shorten the DEC time The 030G/037P and lower models only need braking resistors and the 037G/045P and higher models need braking units
	Output filter	Control the interference from the output side of the VFD and please install close to the output terminals of the VFD.
	Output reactor	Prolong the effective transmitting distance of the VFD to control the sudden high voltage when switching on/off the IGBT of the VFD.

C.3 Power supply

Please see Installation guidelines.

	<ul style="list-style-type: none"> Check that the voltage degree of the VFD complies with the voltage of the supply power voltage.
---	---

C.4 Cables

C.4.1 Power cables

Dimension the input power and motor cables according to local regulations.

- The input power and the motor cables must be able to carry the corresponding load currents.
- The cable must be rated for at least 70 °C maximum permissible temperature of the conductor in continuous use.

- The conductivity of the PE conductor must be equal to that of the phase conductor (same cross-sectional area). For the 030G/037P and higher models, the cross sectional area of the PE grounding conductor can be slightly less than the recommended area.
- Refer to Technical data for the EMC requirements.

A symmetrical shielded motor cable (see the figure below) must be used to meet the EMC requirements of the CE.

A four-conductor system is allowed for input cabling, but a shielded symmetrical cable is recommended. Compared to a four-conductor system, the use of a symmetrical shielded cable reduces electromagnetic emission of the whole drive system as well as motor bearing currents and wear.

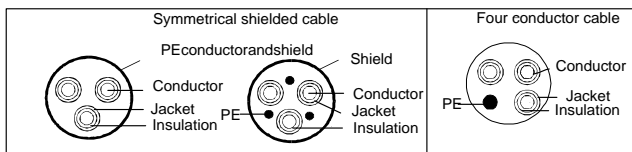

Note: A separate PE conductor is required if the conductivity of the cable shield is not sufficient for the purpose.

To function as a protective conductor, the shield must have the same cross-sectional area as the phase conductors when they are made of the same metal.

To effectively suppress radiated and conducted radio-frequency emissions, the shield conductivity must be at least 1/10 of the phase conductor conductivity. The requirements are easily met with a copper or aluminum shield. The minimum requirement of the motor cable shield of the drive is shown below. It consists of a concentric layer of copper wires. The better and tighter the shield is, the lower the emission level and bearing currents.

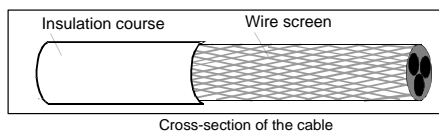

C.4.2 Control cables

All analog control cables and the cable used for the frequency input must be shielded. Use a double-shielded twisted pair cable (Figure a) for analog signals. Employ one individually shielded pair for each signal. Do not use common return for different analog signals.

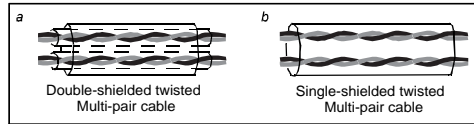

A double-shielded cable is the best alternative for low-voltage digital signals, but a single-shielded or unshielded twisted multi-pair cable (Figure b) is also usable. However, for frequency input, always use a shielded cable.

The relay cable needs the cable type with braided metallic screen.

The keypad needs to connect with cables. It is recommended to use the screen cable on complex electrical magnetic condition.

Note: Run analog and digital signals in separate cables.

Do not make any voltage tolerance or insulation resistance tests (for example hi-pot or megger) on any part of the drive as testing can damage the drive. Every drive has been tested for insulation between the main circuit and the chassis at the factory. Also, there are voltage-limiting circuits inside the drive which cut down the testing voltage automatically.

Check the insulation of the input power cable according to local regulations before connecting to the drive.

Note: Check the insulation of the input power cables according to local regulations before connecting the cables.

VFD model	Recommended cable size(mm ²)				Screw	
	R,S,T U,V,W	PE	P1 (+)	PB (+) (-)	Terminal screw size	Tightening torque (Nm)
GD200A-0R7G-4	1.0	1.0	1.0	1.0	M4	1.2~1.5
GD200A-1R5G-4	1.0	1.0	1.0	1.0	M4	1.2~1.5
GD200A-2R2G-4	1.0	1.0	1.0	1.0	M4	1.2~1.5
GD200A-004G/5R5P-4	1.5/1.5	1.5/1.5	1.5/1.5	1.5/1.5	M4	1.2~1.5
GD200A-5R5G/7R5P-4	1.5/2.5	1.5/2.5	1.5/2.5	1.5/2.5	M4	1.2~1.5
GD200A-7R5G/011P-4	2.5/4	2.5/4	2.5/4	2.5/4	M5	2~2.5
GD200A-011G/015P-4	4/6	4/6	4/6	4/6	M5	2~2.5
GD200A-015G/018P-4	6/10	6/10	6/10	6/10	M5	2~2.5
GD200A-018G/022P-4	10/10	10/10	10/10	10/10	M5	2~2.5
GD200A-022G/030P-4	10/16	10/16	10/16	10/16	M6	3.5~3.8
GD200A-030G/037P-4	16/25	16/25	16/25	16/25	M6	3.5~3.8
GD200A-037G/045P-4	25/25	16/16	25/25	25/25	M8	6~7

VFD model	Recommended cable size(mm ²)				Screw	
	R,S,T U,V,W	PE	P1 (+)	PB (+) (-)	Terminal screw size	Tightening torque (Nm)
GD200A-045G/055P-4	25/35	16/16	25/35	25/35	M8	6~7
GD200A-055G/075P-4	35/50	16/25	35/50	35/50	M8	6~7
GD200A-075G/090P-4	50/70	25/35	50/70	50/70	M10	9~10
GD200A-090G/110P-4	70/95	35/50	70/95	70/95	M10	9~10
GD200A-110G/132P-4	95/95	50/50	95/95	95/95	M10	9~10
GD200A-132G/160P-4	95/150	50/70	95/150	95/150	M12	31~40
GD200A-160G/185P -4	150/185	70/95	150/185	150/185	M12	31~40
GD200A-185G/200P-4	185/ 185	95/95	185/ 185	185/ 185	M12	31~40
GD200A-200G/220P-4	185/ 2x95	95/95	185/ 2x95	185/ 2x95	M12	31~40
GD200A-220G/250P-4	2x95/ 2x95	95/95	2x95/ 2x95	2x95/ 2x95	M12	31~40
GD200A-250G/280P-4	2x95/ 2x150	95/ 150	2x95/ 2x150	2x95/ 2x150	M12	31~40
GD200A-280G/315P-4	2x150/ 2x150	150/ 150	2x150/ 2x150	2x150/ 2x150	M12	31~40
GD200A-315G/355P-4	2x150/ 2x185	150/ 185	2x150/ 2x185	2x150/ 2x185	M12	31~40
GD200A-355G/400P-4	2x185/ 3x150	185/ 2x120	2x185/ 3x150	2x185/ 3x150	M12	31~40
GD200A-400G-4	3x150	2x120	3x150	3x150	M12	31~40
GD200A-450G-4	3x185	2x150	3x185	3x185	M12	31~40
GD200A-500G-4	3x185	2x150	3x185	3x185	M12	31~40

Note:

1. The forward slash "/" is used to distinguish data about G-type VFDs from data about P-type VFDs.
2. It is appropriate to use the recommended cable size under 40°C and rated current. The wiring distance should be no more than 100m.
3. Terminals P1, (+), PB and (-) connects the DC reactor options and parts.

C.4.3 Routing the cables

Route the motor cable away from other cable routes. Motor cables of several drives can be run in parallel installed next to each other. It is recommended that the motor cable, input power cable and control cables are installed on separate trays. Avoid long parallel runs of motor cables with other

cables to decrease electromagnetic interference caused by the rapid changes in the drive output voltage.

Where control cables must cross power cables make sure that they are arranged at an angle as near to 90 degrees as possible.

The cable trays must have good electrical bonding to each other and to the grounding electrodes. Aluminum tray systems can be used to improve local equalizing of potential.

A figure of the cable routing is shown below.

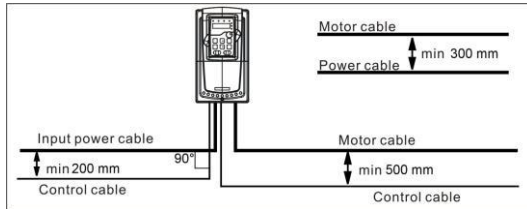

C.4.4 Checking the insulation

Check the insulation of the motor and motor cable as follows:

1. Check that the motor cable is connected to the motor and disconnected from the drive output terminals U, V and W.
2. Measure the insulation resistance between each phase conductor and the Protective Earth conductor using a measuring voltage of 500 V DC. For the insulation resistance of other motors, please consult the manufacturer's instructions.

Note: Moisture inside the motor casing will reduce the insulation resistance. If moisture is suspected, dry the motor and repeat the measurement.

C.5 Breaker, electromagnetic contactor and leakage protection switch

Due to the VFD output high frequency PWM voltage waveform, and the existence of distributed capacitance between IGBT and heat sink in internal VFD and the distributed capacitance between motor stator and rotor, the VFD will inevitably generate high-frequency leakage current to ground. The high-frequency leakage current will back flow to grid through the earth to interference the leakage protection switch, thus causing the leakage protection switch malfunction. This is due to the VFD output voltage characteristics inherent in the decision.

To ensure the stability of the system, it is recommended to use the VFD dedicated leakage protection switch which rated residual operation current 30mA or more(for example, corresponds to IEC60755 Type B). If you are not using the VFD dedicated leakage protection switch caused by malfunction, try to reduce the carrier frequency, or replace the electromagnetic leakage protection switch which rated residual operating current of 200mA or more.

It is necessary to add fuse for the avoidance of overload.

It is appropriate to use a breaker (MCCB) which complies with the VFD power in the 3-phase AC power and input power and terminals (R, S and T). The capacity of the VFD should be 1.5-2 times of the rated current.



- Due to the inherent operating principle and construction of circuit breakers, independent of the manufacturer, hot ionized gases may escape from the breaker enclosure in case of a short-circuit. To ensure safe use, special attention must be paid to the installation and placement of the breakers. Follow the manufacturer's instructions.

VFD model	Breaker rated current (A)	Fuse rated current (A)	Contactors rated current (A)
GD200A-0R7G-4	4	5	9
GD200A-1R5G-4	6	10	9
GD200A-2R2G-4	10	10	9
GD200A-004G/5R5P-4	20/25	20/35	18/25
GD200A-5R5G/7R5P-4	25/32	35/40	25/32
GD200A-7R5G/011P-4	32/50	40/50	32/38
GD200A-011G/015P-4	50/63	50/60	38/50
GD200A-015G/018P-4	63/63	60/70	50/65
GD200A-018G/022P-4	63/80	70/90	65/80
GD200A-022G/030P-4	80/100	90/125	80/80
GD200A-030G/037P-4	100/125	125/125	80/98
GD200A-037G/045P-4	125/140	125/150	98/115
GD200A-045G/055P-4	140/180	150/200	115/150
GD200A-055G/075P-4	180/225	200/250	150/185
GD200A-075G/090P-4	225/250	250/300	185/225
GD200A-090G/110P-4	250/315	300/350	225/265
GD200A-110G/132P-4	315/400	350/400	265/330
GD200A-132G/160P-4	400/500	400/500	330/400
GD200A-160G/185P-4	500/500	500/600	400/400
GD200A-185G/200P-4	500/630	600/600	400/500
GD200A-200G/220P-4	630/630	600/700	500/500
GD200A-220G/250P-4	630/700	700/800	500/630
GD200A-250G/280P-4	700/800	800/1000	630/630
GD200A-280G/315P-4	800/1000	1000/1000	630/800
GD200A-315G/355P-4	1000/1000	1000/1000	800/800
GD200A-355G/400P-4	1000/1000	1000/1200	800/1000
GD200A-400P-4	1000	1200	1000

VFD model	Breaker rated current (A)	Fuse rated current (A)	Contactor rated current (A)
GD200A-400G-4	1000	1200	1000
GD200A-450G-4	1250	1200	1000
GD200A-500G-4	1250	1400	1000

Note: The forward slash "/" is used to distinguish data about G-type VFDs from data about P-type VFDs.

C.6 Reactors

When the distance between the VFD and motor is longer than 50 m, the parasitic capacitance between the long cable and ground may cause large leakage current, and overcurrent protection of the VFD may be frequently triggered. To prevent this from happening and avoid damage to the motor insulator, compensation must be made by adding an output reactor. When a VFD is used to drive multiple motors, take the total length of the motor cables (that is, sum of the lengths of the motor cables) into account. When the total length is longer than 50 m, an output reactor must be added on the output side of the VFD. If the distance between the VFD and motor ranges from 50 m to 100 m, select the reactor according to the following table. If the distance is longer than 100 m, contact INVT's technical support. The mapping between VFD models and reactors is as follows:

VFD model	Input reactor		DC reactor	Output reactor	
	G-type	P-type		G-type	P-type
GD200A-0R7G-4	ACL2-1R5-4	/	/	OCL2-1R5-4	/
GD200A-1R5G-4	ACL2-1R5-4	/	/	OCL2-1R5-4	/
GD200A-2R2G-4	ACL2-2R2-4	/	/	OCL2-2R2-4	/
GD200A-004G/5R5P-4	ACL2-004-4	ACL2-5R5-4	/	OCL2-004-4	OCL2-5R5-4
GD200A-5R5G/7R5P-4	ACL2-5R5-4	ACL2-7R5-4	/	OCL2-5R5-4	OCL2-7R5-4
GD200A-7R5G/011P-4	ACL2-7R5-4	ACL2-011-4	/	OCL2-7R5-4	OCL2-011-4
GD200A-011G/015P-4	ACL2-011-4	ACL2-015-4	/	OCL2-011-4	OCL2-015-4
GD200A-015G/018P-4	ACL2-015-4	ACL2-018-4	/	OCL2-015-4	OCL2-015-4
GD200A-018G/022P-4	ACL2-018-4	ACL2-018-4	/	OCL2-018-4	OCL2-018-4
GD200A-022G/030P-4	ACL2-022-4	ACL2-037-4	/	OCL2-022-4	OCL2-022-4
GD200A-030G/037P-4	ACL2-037-4	ACL2-037-4	/	OCL2-037-4	OCL2-037-4
GD200A-037G/045P-4	ACL2-037-4	ACL2-045-4	DCL2-037-4	OCL2-037-4	OCL2-037-4
GD200A-045G/055P-4	ACL2-045-4	ACL2-055-4	DCL2-045-4	OCL2-045-4	OCL2-045-4
GD200A-055G/075P-4	ACL2-055-4	ACL2-055-4	DCL2-055-4	OCL2-055-4	OCL2-055-4
GD200A-075G/090P-4	ACL2-075-4	ACL2-075-4	DCL2-075-4	OCL2-075-4	OCL2-075-4
GD200A-090G/110P-4	ACL2-110-4	ACL2-110-4	DCL2-090-4	OCL2-110-4	OCL2-110-4
GD200A-110G/132P-4	ACL2-110-4	ACL2-160-4	DCL2-132-4	OCL2-110-4	OCL2-200-4
GD200A-132G/160P-4	ACL2-160-4	ACL2-160-4	DCL2-132-4	OCL2-200-4	OCL2-200-4

VFD model	Input reactor		DC reactor	Output reactor	
	G-type	P-type		G-type	P-type
GD200A-160G/185P-4	ACL2-160-4	ACL2-200-4	DCL2-160-4	OCL2-200-4	OCL2-200-4
GD200A-185G/200P-4	ACL2-200-4	ACL2-200-4	DCL2-220-4	OCL2-200-4	OCL2-200-4
GD200A-200G/220P-4	ACL2-200-4	ACL2-280-4	DCL2-220-4	OCL2-200-4	OCL2-280-4
GD200A-220G/250P-4	ACL2-280-4	ACL2-280-4	DCL2-280-4	OCL2-280-4	OCL2-280-4
GD200A-250G/280P-4	ACL2-280-4	ACL2-280-4	DCL2-280-4	OCL2-280-4	OCL2-280-4
GD200A-280G/315P-4	ACL2-280-4	ACL2-350-4	DCL2-280-4	OCL2-280-4	OCL2-350-4
GD200A-315G/355P-4	ACL2-350-4	ACL2-350-4	DCL2-315-4	OCL2-350-4	OCL2-350-4
GD200A-355G/400P-4	Standard	Standard	DCL2-400-4	OCL2-350-4	OCL2-400-4
GD200A-400G-4	Standard	/	DCL2-400-4	OCL2-400-4	/
GD200A-450G-4	Standard	/	DCL2-500-4	OCL2-500-4	/
GD200A-500G-4	Standard	/	DCL2-500-4	OCL2-500-4	/

Note:

1. The rated derate voltage of the input reactor is 2%±15%.
2. The power factor of the input side is above 90% after adding DC reactor.
3. The rated derate voltage of the output reactor is 1%±15%.
4. The preceding optional parts are externally connected. If the 220G/250P–315G/355P models use the optional bases, two reactors can be configured for each VFD.

C.7 Filters

J10 is not connected by default for the 110G/132P and lower models. If it is needed to fulfill the requirements of C3 class, users can connect jumper J10 which is put in the same bag with the operation manual.

The 132G/160P and higher models can satisfy C3 requirements and J10 is connected by default.

Note: Disconnect J10 when either of below situations occurs:

1. EMC filter is suitable for the neutral-grounding grid system. If it is used in IT grid system (neutral point is not grounded), disconnect J10;
2. During configuring residual current circuit-breaker, if tripping occurred during startup, disconnect J10.

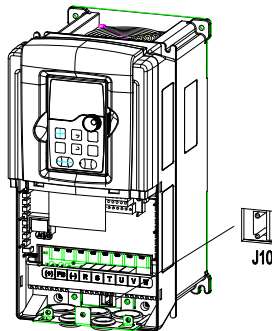

Filters for Goodrive200A series VFDs

VFD model	Input filter	Output filter
GD200A-0R7G-4	FLT-P04006L-B	FLT-L04006L-B
GD200A-1R5G-4		
GD200A-2R2G-4		
GD200A-004G/5R5P-4	FLT-P04016L-B	FLT-L04016L-B
GD200A-5R5G/7R5P-4		
GD200A-7R5G/011P-4	FLT-P04032L-B	FLT-L04032L-B
GD200A-011G/015P-4		
GD200A-015G/018P-4	FLT-P04045L-B	FLT-L04045L-B
GD200A-018G/022P-4		
GD200A-022G/030P-4	FLT-P04065L-B	FLT-L04065L-B
GD200A-030G/037P-4		
GD200A-037G/045P-4	FLT-P04100L-B	FLT-L04100L-B
GD200A-045G/055P-4		
GD200A-055G/075P-4	FLT-P04150L-B	FLT-L04150L-B
GD200A-075G/090P-4		
GD200A-090G/110P-4	FLT-P04240L-B	FLT-L04240L-B
GD200A-110G/132P-4		
GD200A-132G/160P-4		
GD200A-160G/185P-4	FLT-P04400L-B	FLT-L04400L-B
GD200A-185G/200P-4		
GD200A-200G/220P-4		
GD200A-220G/250P-4	FLT-P04600L-B	FLT-L04600L-B
GD200A-250G/280P-4		
GD200A-280G/315P-4		



VFD model	Input filter	Output filter
GD200A-315G/355P-4	FLT-P04800L-B	FLT-L04800L-B
GD200A-355G/400P-4		
GD200A-400G-4		
GD200A-450G-4	FLT-P041000L-B	FLT-L041000L-B
GD200A-500G-4		

Note: The input EMI meet the requirement of C2 after adding input filters.

C.8 Braking system

C.8.1 Select the braking components

It is appropriate to use braking resistor or braking unit when the motor brakes sharply or the motor is driven by a high inertia load. The motor will become a generator if its actual rotating speed is higher than the corresponding speed of the reference frequency. As a result, the inertial energy of the motor and load return to the VFD to charge the capacitors in the main DC circuit. When the voltage increases to the limit, damage may occur to the VFD. It is necessary to apply braking unit/resistor to avoid this accident happens.

	<ul style="list-style-type: none"> ● Only qualified electricians are allowed to design, install, commission and operate on the VFD. ● Follow the instructions in "warning" during working. Physical injury or death or serious property may occur. ● Only qualified electricians are allowed to wire. Damage to the VFD or braking options and part may occur. Read carefully the instructions of braking resistors or units before connecting them with the VFD. ● Do not connect the braking resistor with other terminals except for PB and (-). Do not connect the braking unit with other terminals except for (+) and (-). Damage to the VFD or braking circuit or fire may occur.
	<ul style="list-style-type: none"> ● Connect the braking resistor or braking unit with the VFD according to the diagram. Incorrect wiring may cause damage to the VFD or other devices.

Goodrive200A series VFDs of the 030G/037P and lower models need internal braking units and the VFDs of the 037G/045P and higher models need external braking units. Please select the resistance and power of the braking resistors according to actual utilization.

Note:

Select the resistor and power according to the provided data.

The braking torque may increase because of the raising of braking resistor. The below table is calculated at 100% of the braking torque, 10%, 50% and 80%of the braking usage ratio. The user can select according to the actual working.

Refer to the operation instructions of braking units when using external units for right setting of voltage degree. Otherwise normal operation of the VFD may be impacted.

VFD model	Braking unit type	100% of braking torque (Ω)	The consumed power of the braking resistor			Min. Braking Resistor (Ω)
			10% braking	50% braking	80% braking	
GD200A-0R7G-4	Internal braking unit	653	0.1	0.6	0.9	240
GD200A-1R5G-4		326	0.23	1.1	1.8	170
GD200A-2R2G-4		222	0.33	1.7	2.6	130
GD200A-004G/5R5P-4		122	0.6	3	4.8	80
GD200A-5R5G/7R5P-4		89	0.75	4.1	6.6	60
GD200A-7R5G/011P-4		65	1.1	5.6	9	47
GD200A-011G/015P-4		44	1.7	8.3	13.2	31
GD200A-015G/018P-4		32	2	11	18	23
GD200A-018G/022P-4		27	3	14	22	19
GD200A-022G/030P-4		22	3	17	26	17
GD200A-030G/037P-4		17	5	23	36	17
GD200A-037G/045P-4		DBU100H-060-4	13	6	28	44
GD200A-045G/055P-4	DBU100H-110-4	10	7	34	54	6.4
GD200A-055G/075P-4		8	8	41	66	
GD200A-075G/090P-4		6.5	11	56	90	
GD200A-090G/110P-4	DBU100H-160-4	5.4	14	68	108	4.4
GD200A-110G/132P-4		4.5	17	83	132	
GD200A-132G/160P-4	DBU100H-220-4	3.7	20	99	158	3.2
GD200A-160G/185P-4	DBU100H-320-4	3.1	24	120	192	2.2
GD200A-185G/200P-4		2.8	28	139	222	
GD200A-200G/220P-4		2.5	30	150	240	
GD200A-220G/250P-4	DBU100H-400-4	2.2	33	165	264	1.8
GD200A-250G/280P-4		2.0	38	188	300	
GD200A-280G/315P-4	Two DBU100H-320-4	3.6*2	21*2	105*2	168*2	2.2*2
GD200A-315G/355P-4		3.2*2	24*2	118*2	189*2	
GD200A-355G/400P-4		2.8*2	27*2	132*2	210*2	
GD200A-400G-4		2.4*2	30*2	150*2	240*2	
GD200A-450G-4	Two	2.2*2	34*2	168*2	270*2	1.8*2
GD200A-500G-4	DBU100H-400-4	2*2	38*2	186*2	300*2	



- Never use a brake resistor with a resistance below the minimum value specified for the particular drive. The drive and the internal chopper are not able to handle the overcurrent caused by the low resistance.



- Increase the power of the braking resistor properly in the frequent braking situation (the frequency usage ratio is more than 10%).

C.8.2 Select the brake resistor cables

Use a shielded cable to the resistor cable.

C.8.3 Place the brake resistor

Install all resistors in a place where they will cool.

	<ul style="list-style-type: none"> ● The materials near the brake resistor must be non-flammable. The surface temperature of the resistor is high. Air flowing from the resistor is of hundreds of degrees Celsius. Protect the resistor against contact.
---	--

Installation of the braking resistor:

	<ul style="list-style-type: none"> ● The 030G/037P and lower models only need external braking resistors. ● PB and (+) are the wiring terminals of the braking resistors.
---	---

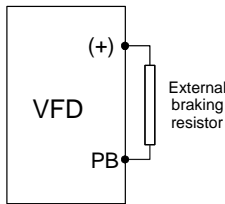



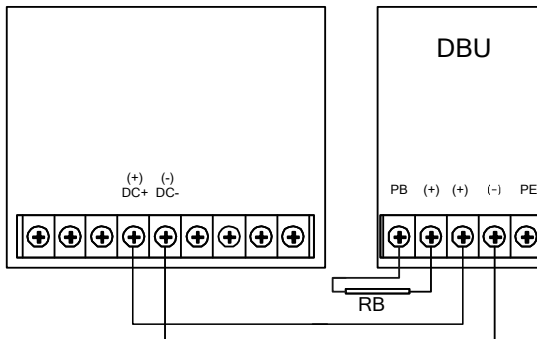

Installation of braking units:

	<ul style="list-style-type: none"> ● The 037G/045P and higher models only need external braking units. ● (+), (-) are the wiring terminals of the braking units. ● The wiring length between the (+),(-) terminals of the VFD and the (+),(-) terminals of the braking units should be no more than 5m, and the distributing length among BR1 and BR2 and the braking resistor terminals should be no more than 10m.
---	---

Signal installation is as below:

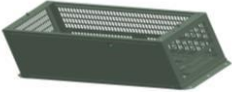

C.9 Other optional parts

No.	Optional part	Instruction	Picture
1	Flange installation bracket	Needed for the flange installation of the 0R7G-030G/037P models Not needed for the flange installation of the 037G/045P-200G/220P models	
2	Installation base	Optimal for the 220G/250P-315G/355P models An input AC/DC reactor and output AC reactor can be put in the base.	
3	Installation bracket	Use the screw or installation bracket to fix the external keypad. Optional for the 0R7G-030G/037P models and standard for the 037G/045P-500G models	
4	Side cover	Protect the internal circuit in serious environment. Derate when selecting the cover. Please contact INVT for detailed information.	
5	LCD Keypad	Support several languages, parameters copy, high-definition display and the installation dimension is compatible with the LED keypad.	
6	LED keypad	Optional for the 0R7G-015G/018P models.	

Appendix D Further Information

D.1 Product and service inquiries

Address any inquiries about the product to your local INVT offices, quoting the type designation and serial number of the unit in question. A listing of INVT sales, support and service contacts can be found by navigating to www.invt.com.

D.2 Feedback on INVT VFD manuals

Your comments on our manuals are welcome. Go to www.invt.com, directly contact online service personnel or choose **Contact** to obtain contact information.

D.3 Document library on the internet

You can find manuals and other product documents in PDF format on the Internet. Go to www.invt.com and choose **Support > Download**.

 021-88406044
09106611367
WWW.LSKALA.COM



Service line:86-755-23535967 E-mail:overseas@invt.com.cn Website:www.invt.com

The products are owned by **Shenzhen INVT Electric Co.,Ltd.**

Two companies are commissioned to manufacture: (For product code, refer to the 2nd/3rd place of S/N on the name plate.)

Shenzhen INVT Electric Co., Ltd. (origin code: 01)

Address: INVT Guangming Technology Building, Songbai Road,
Matian, Guangming District, Shenzhen, China

INVT Power Electronics (Suzhou) Co., Ltd. (origin code: 06)

Address: 1# Kuntun Mountain Road, Science&Technology Town,
Gaixin District, Suzhou, Jiangsu, China

Industrial Automation: ■ HMI ■ PLC ■ VFD ■ Servo System
■ Elevator Intelligent Control System ■ Rail Transit Traction System

Energy & Power: ■ UPS ■ DCIM ■ Solar Inverter ■ SVG
■ New Energy Vehicle Powertrain System ■ New Energy Vehicle Charging System
■ New Energy Vehicle Motor



66001-00342

Copyright© INVT.

Manual information may be subject to change without prior notice.

202201 (V2.8)